

STAR FLEET

STARSHIP RECOGNITION MANUAL

REPORT:

CONSTITUTION HEAVY CRUISERS

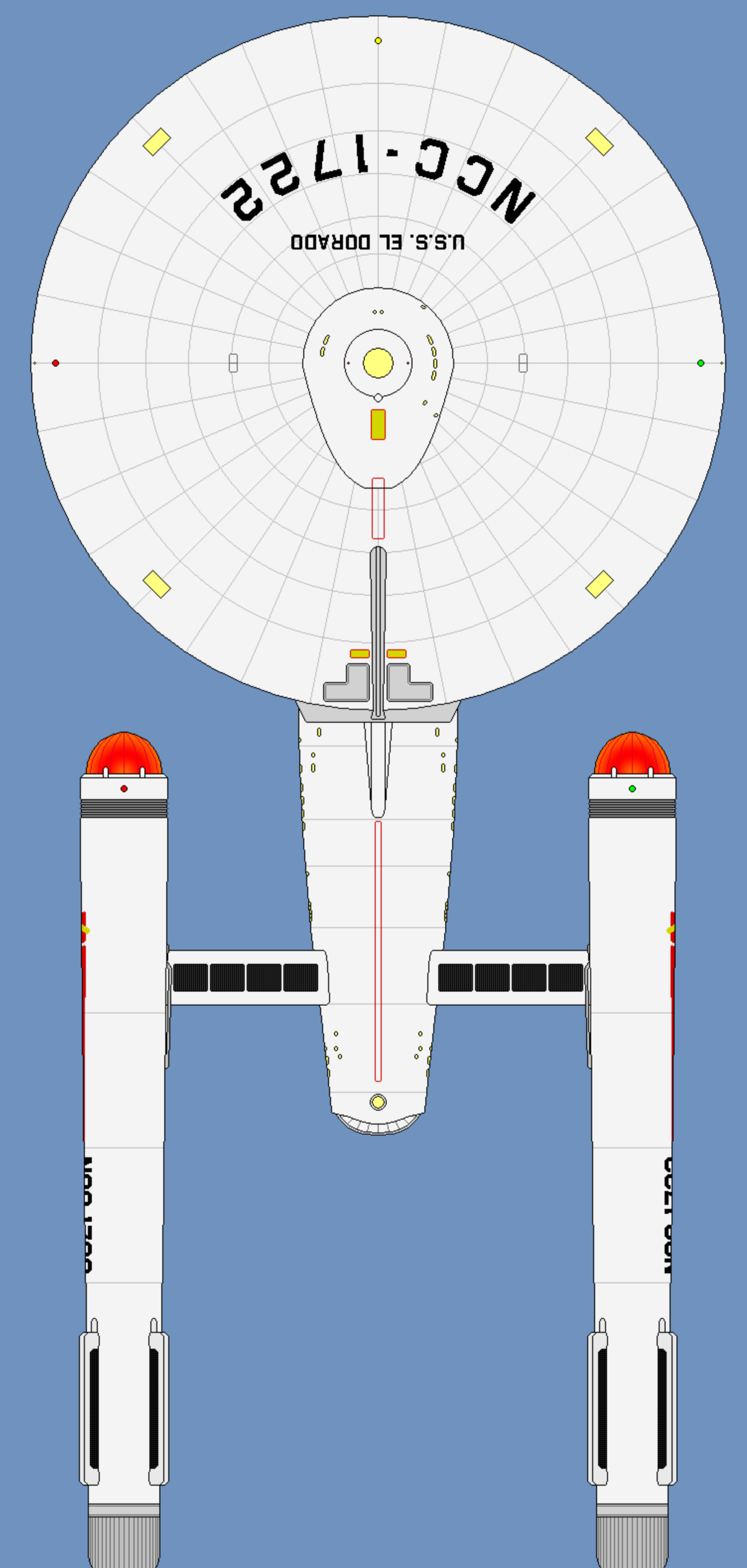



FORWARD

My contribution to this project would not have been possible without those who came before me. Mainly, CaptShade, whose original drawings laid the foundation for my work by providing me the figurative and literal tools for my own creative output. Nichodo, who was a big help in creating aft and ventral views of various components. RevancheRM, whose ideas and drive helped me get a little more creative and better at something I really enjoy. And, most definitely, Neale "Vance" Davidson, whose enormous volume of work got me interested in doing this in the first place, and for inspiring us all.

- Adrasil

First, as always, thanks to Adrasil. Since partnering with him, I've taken some great artwork and added some context to it. He's really allowed me to scratch my writing itch, to the point it sometimes bleeds, but still feels Oh-So-Good. Next up, of course, is Timo Saloniemi, who's work I've been following for around two decades and I greatly respect. The artwork in these "Starship Recognition Manuals" are 97% based upon the ones he describes textually in his grand opus, the "Hobbyist's Guide to the UFP Starfleet and Its History," and 3% derived from what he has inspired in us.

- RevancheRM

Additional reports may be found at: starshiptracker.com/deltadynamics

CREDITS

ADRASIL: All imagery (unless otherwise credited)

www.DeviantArt.com/Adrasil

REVANCHERM: All writing (unless otherwise credited)

www.DeviantArt.com/RevancheRM

NEALE 'VANCE' DAVIDSON/JAYNZ: Project & cover concepts

www.DeviantArt.com/TFVanguard

Jaynz.Trekships.org

STAR TREK DESIGN PROJECT: Source of sponsor icons

www.StarTrekDesignProject.com

TIMO SALONIEMI: Author of "Hobbyist's Guide to the UFP Starfleet", the inspiration for these

SRMs. A direct link to his Google Drive may be found on most deviations in

RevancheRM's gallery.

VIPERAVIATOR: Source of adapted cover starburst

www.DeviantArt.com/ViperAviator

CONSTITUTION CLASS:

- Original inspiration from: Star Trek (The Original Series), Star Trek: Enterprise, Star Fleet Technical Manual (Franz Joseph), Ships of the Star Fleet (Calon Riel), FASA

- Incorporated parts from: CaptShade, Gundam1701, & Nichodo

NOTE FROM THE WRITING EDITOR

These ships do not always exactly match the specifications Timo provides in his technical section for each class, as I've adapted them in ways that allowed them to fit a bit better with the guidance provided by the starship construction rules in Steven Long's "Spacedock". I've also changed some dates around when I found them in conflict with other information Timo has provided. These two books greatly inform my own alpha-canon and I urge you to look up both online, as offered free by their respective authors. (Links to both are provided on the Delta Dynamics site.)

Delta Dynamics' Starship Recognition Manual, along with the Reports and all other similar publications released under that branding, are released as a public service to familiarize interested beings with the historic starship designs and technical developments of the United Federation of Planets Star Fleet, its member and preceding services, and those services of regional galactic neighbors. Despite the occasional presence of a sensitive nature of both those historic events and technical matters discussed herein, the distribution and handling of this publication has been ruled Security Grade 0 (Unclassified) by Star Fleet Support Operations, Office of Security.

Copyright 2420 by Delta Dynamics, Wellington, Earth.

Memory Terra/Memory Alpha Cataloging Data: UFP ITP/TE 7259381460298

Under the laws of the United Federation of Planets and its members, use or reproduction (in whole or in part) of the information contained in this publication—along with proper attribution of its source—is granted. This edition is authorized for distribution only in member star systems of the UFP its territories and possessions, affiliated star systems, and select independent or neutral star systems. "Star Trek" and all related likenesses are copyrights and trademarks of CBS Television Studios and Paramount Pictures. This publication has been established for informational and entertainment purposes only. No infringement of copyright nor trademark is intended. I have simply made the logical deduction that you are a liar.



CONTENTS

CONSTELLATION	FUSION TESTBED	PG 02:01
CONSTELLATION	DILITHIUM TESTBED	PG 02:05
REPUBLIC	HEAVY CRUISER PROTOTYPE	PG 02:08
CONSTITUTION	HEAVY CRUISER PRODUCTION PROTOTYPE	PG 02:13
USS ENTERPRISE	HEAVY CRUISER PRODUCTION PROTOTYPE	PG 02:18
USS CONSTITUTION	HEAVY CRUISER (OPERATIONAL STANDARD)	PG 02:23
USS CONSTELLATION	HEAVY CRUISER (OPERATIONAL STANDARD)	PG 02:27
USS REPUBLIC	HEAVY CRUISER (OPERATIONAL STANDARD)	PG 02:31
CONSTITUTION FLIGHT II	HEAVY CRUISER	PG 02:35
BONHOMME RICHARD	HEAVY CRUISER	PG 02:40
BONHOMME RICHARD (TYPE 2)	HEAVY CRUISER	PG 02:44
BONHOMME RICHARD (TYPE 3)	HEAVY CRUISER	PG 02:48
CONSTITUTION FLIGHT III	HEAVY CRUISER	PG 02:52
VICTORY	HEAVY CRUISER	PG 02:56
USS REPUBLIC	ACADEMY TRAINER	PG 02:60
CLASS TIMELINE		PG 03:01
STARSHIP COMPARISON GUIDE		PG 03:10
GLOSSARY		PG 03:13
SPONSORS		PG 03:16
OTHER PUBLICATIONS		PG 03:17



CONSTELLATION FUSION TESTBED

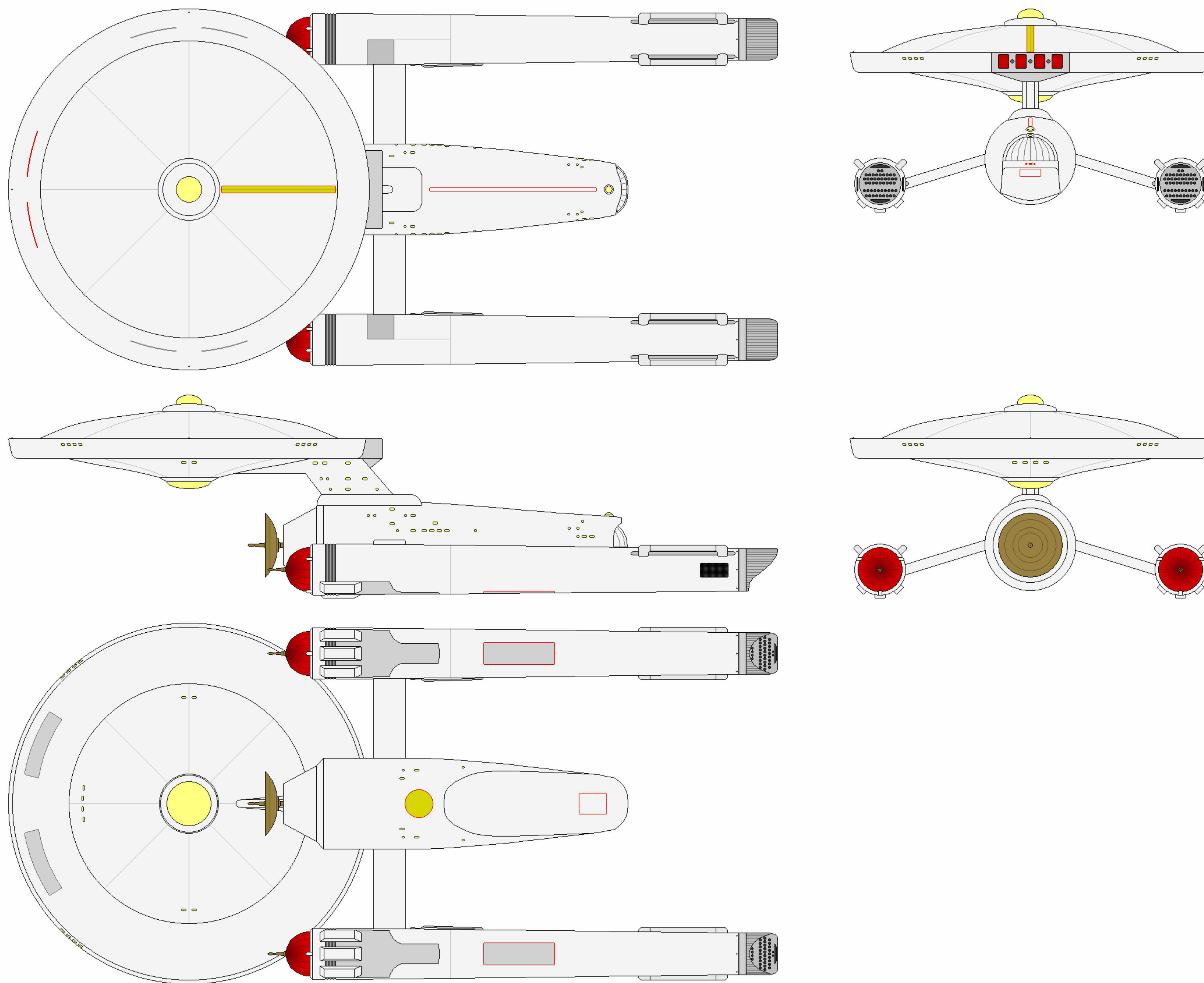

CATEGORY: HEAVY CRUISER TESTBED
OPERATIONAL: 2226
MODIFIED: 1 (ADVANCE SUBCLASS)

DIMENSIONS:
LENGTH: 243.0 M
BEAM: 114.1 M
HEIGHT: 64.1 M
MASS: 592,600 MT

TACTICAL: N/A

AUXILIARIES:
- 2X LIGHT SHUTTLES
- 2X SHUTTLEPODS
- 1X WORK POD

PERFORMANCE:
CRUISE: WARP 5.6 (OCU)
MAX: N/A
ENDURANCE: N/A

COMPLEMENT:
CREW: VARIED FOR TESTING



CONSTELLATION FUSION TESTBED AUTHORIZED CONSTRUCTION

THE FOLLOWING DECOMMISSIONED SHIP WAS AUTHORIZED BY FEDERATION COUNCIL RESOLUTION TO TAKE PART IN AND BE MODIFIED FOR TESTING REQUESTED BY STAR FLEET STAFF REQUIREMENT.

CONSTELLATION

GENERAL INFORMATION

The challenges encountered during the operational lifespan of the Horizon heavy cruiser and its variants is provided in that series of articles. However, the 2210 failure of the dual SSWR-IX fusion reactors to reliably power the ginormous PB-19 nacelles into supercruise ranges was not seen as a block to developing a class of cruiser that could not only match the increasing Klingon threat, but surpass it in combat. Up-and-coming Andorian-based Chiokis Starship Construction Corporation promised the Horizons could be modified with their newly developed saucer hull and modernized warp nacelles to achieve the speed performance such a vessel would need in order to respond promptly to varied threats and requirements associated with the expanding Federation borders.

In 2222, Star Fleet provided two low-fatigue Horizons to the shipbuilder, with the presumption they would have these heavy cruisers, developed under the classified term "Project Starship", by the end of 2225 at the latest. Operational plans were already being drawn up to employ these yet-undefined super vessels throughout the Federation and its territories; Star Fleet's plans would remain largely unfulfilled until 2245. However, progress—even when languid and uncertain—was being made over those 23 intervening years.

USS Constellation (NCC-1017) had suffered major damage to her bow structures in 2219, while USS Republic (NCC-1371), newly commissioned, had received heavy internal damage in the bow from a large, rampant fire that was largely unimpeded by the damage control efforts, though with considerable contamination from the ineffective usage of fire suppressants. Despite the respective lightyears of distance and calamities suffered, the ships overall were still seen as viable platforms, with little structural stress of the secondary hulls. The bow saucers and their mounting structures, navigational deflectors, and weapons arrays were all removed, leaving two headless warp bodies floating in their remote drydocks.

Primary developmental focus was on the [former] Constellation. Republic would be saved to recreate the final design as a method of developing procedures for upgrading the rest of the Horizon family to that standard. Constellation, however, would be the proverbial guinea pig that would lead to the final design. After years of considerable effort, a non-functional saucer and connection neck were gamma-welded onto the forward dorsal of the engineering hull so that dynamic testing could be undertaken. Computer simulations of the conjoined hulls were also conducted, with various real and hypothetical warp nacelles indicating their interactions against the hull surfaces.

In 2226, the ideal nacelle for the original pylon placements was realized: the third-generation PB-30A, with much more petite—though longer—pylons placed on the original respective hull mounts and at the same angle. An extremely large but advanced compression fusion powerplant was installed in the engineering hull and a relatively non-descript but fully-functional saucer, with an advanced impulse bank, replaced the dummy one. The ship was alive once again.

Unfortunately, the trial runs proved rather disappointing. Potentially disastrous resonances were detected in three different locations—one for the saucer, two for areas under and behind the secondary hull—that had not been anticipated by the preceding computer simulations. Apparently, the metrics gathered by the sensors suggested several possible solutions, including major modifications to the engineering hull, a path Star Fleet sought to avoid for both economical and scheduling reasons. However, additional testing of differing nacelle placements could still be pursued. Also, there lay the possibility of newbuilds, which would allow the Horizon class to remain fully functional in the meantime. Chiokis was authorized to begin parallel studies.

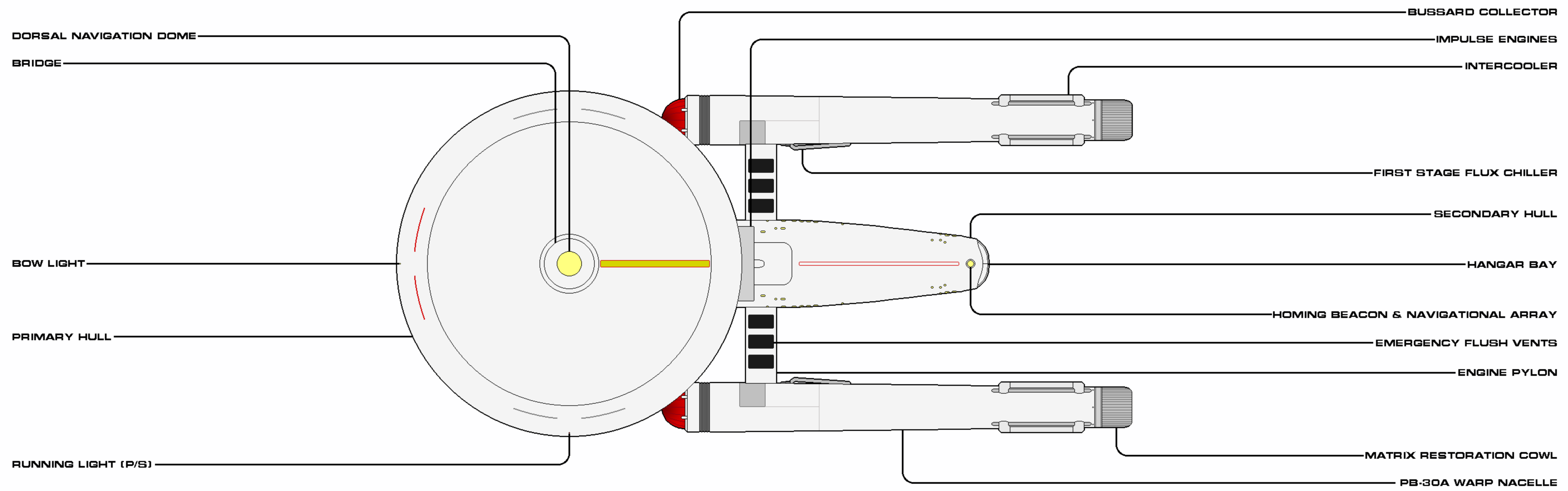
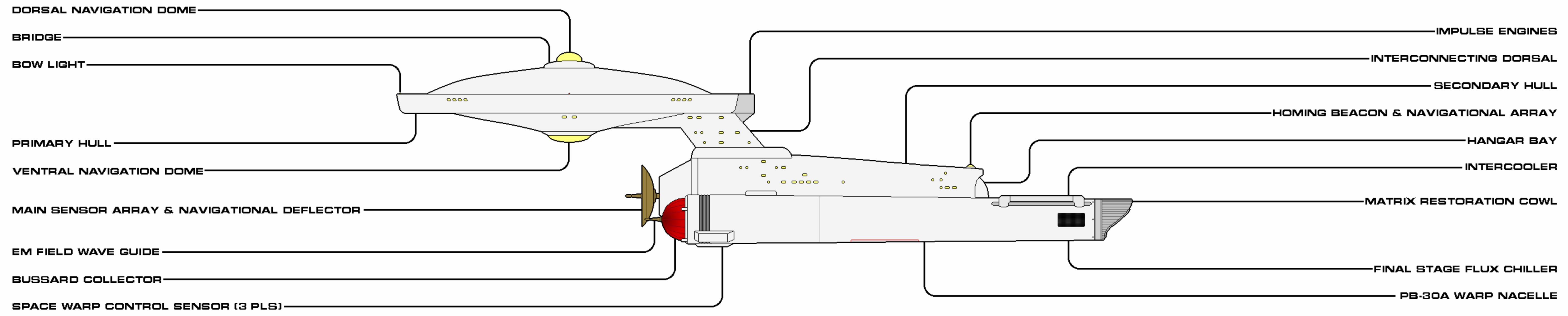

SHEET 1 OF 2

CLASS	CONSTELLATION	CATEGORY	FUSION TESTBED
VARIANT	NA	MODIFIED	2226
LENGTH	243.0 M	BEAM	114.1 M
HEIGHT	64.1 M	MASS	592,600 MT
OPERATIONAL	1	RELEASE DATE	2001.30

Authorized for release by Star Fleet Bureau of Starship Construction



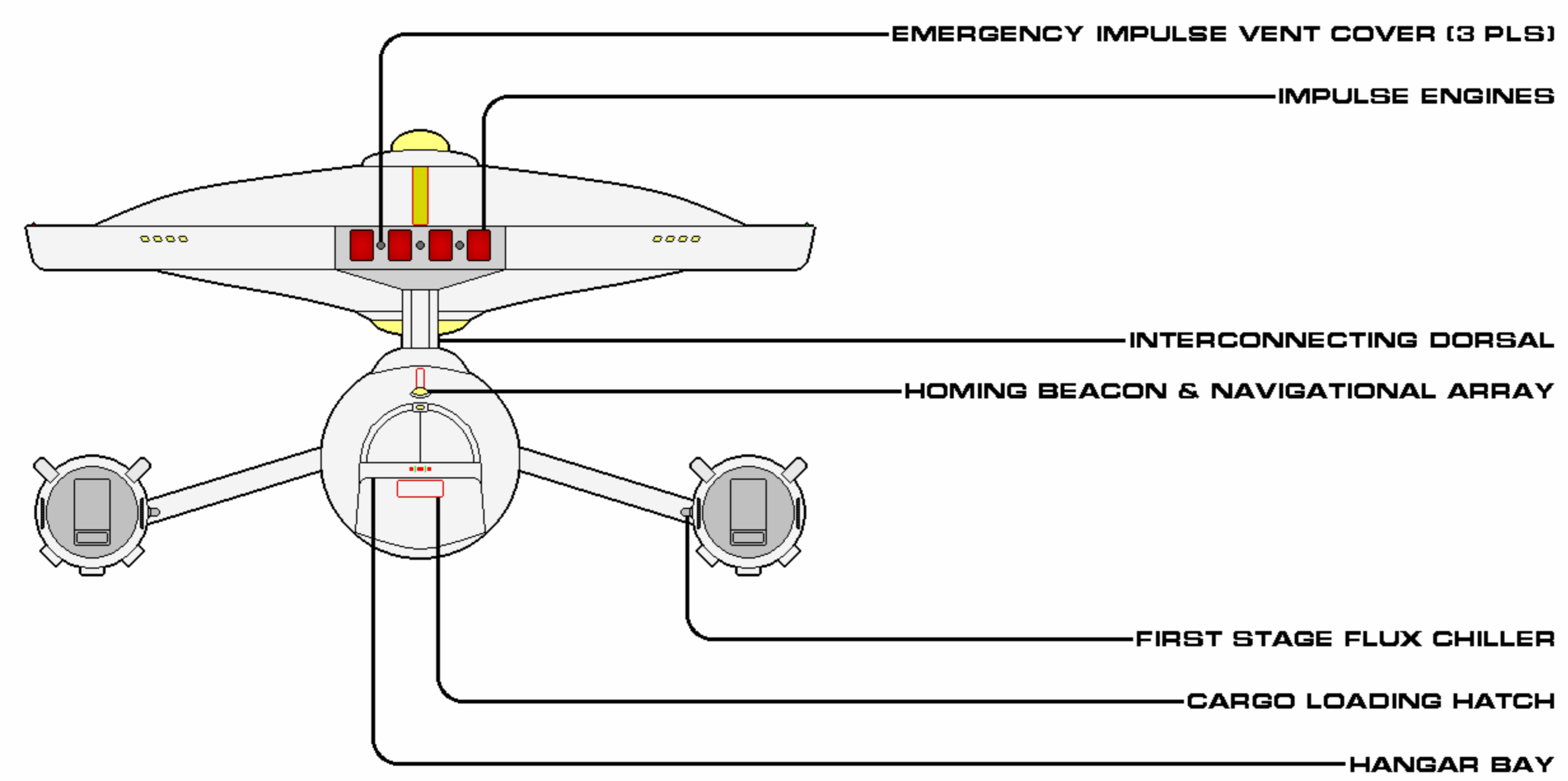
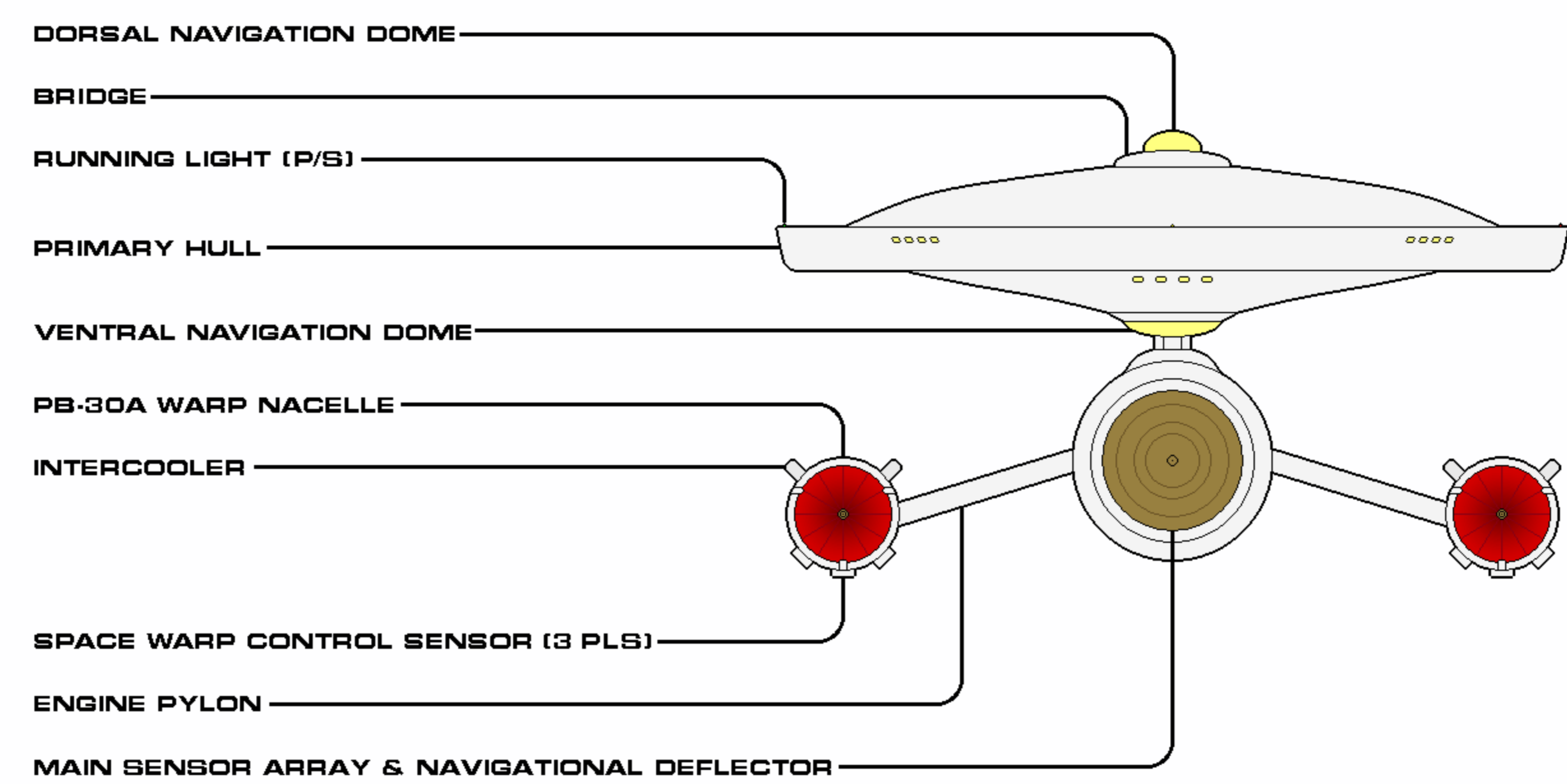
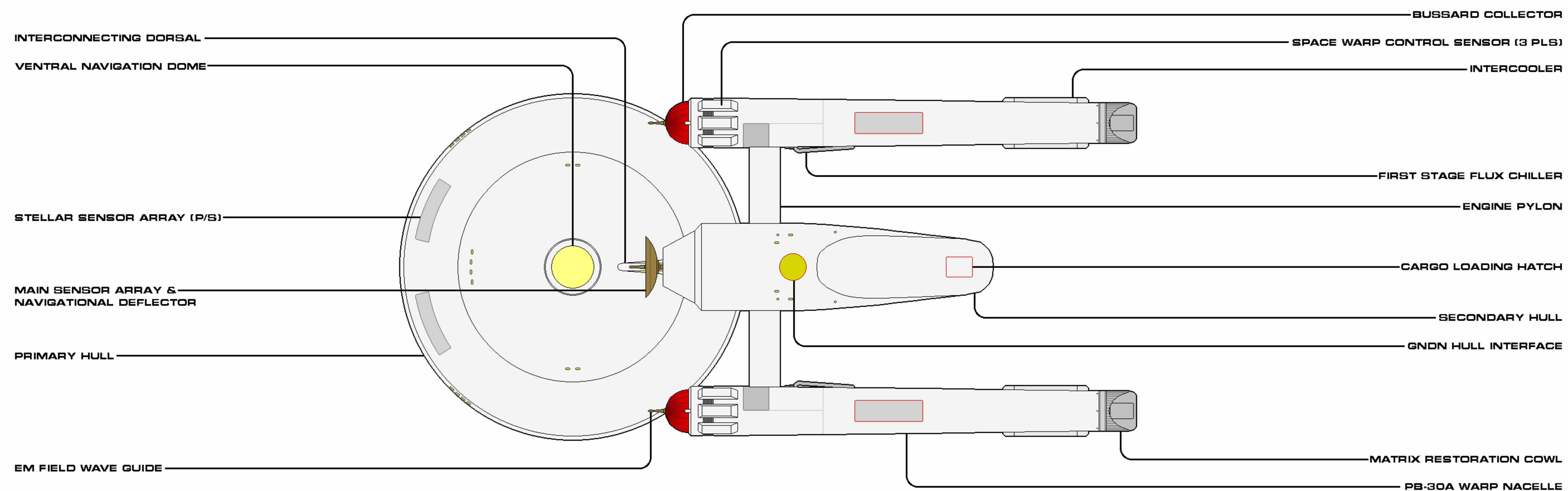

SHEET 2 OF 2

CLASS	CONSTELLATION	CATEGORY	FUSION TESTBED
VARIANT	N/A	MODIFIED	2226
LENGTH	243.0 M	BEAM	114.1 M
HEIGHT	64.1 M	MASS	592,600 MT
OPERATIONAL	1	RELEASE DATE	2001.30

Authorized for release by Star Fleet Bureau of Starship Construction

CONSTELLATION DILITHIUM TESTBED

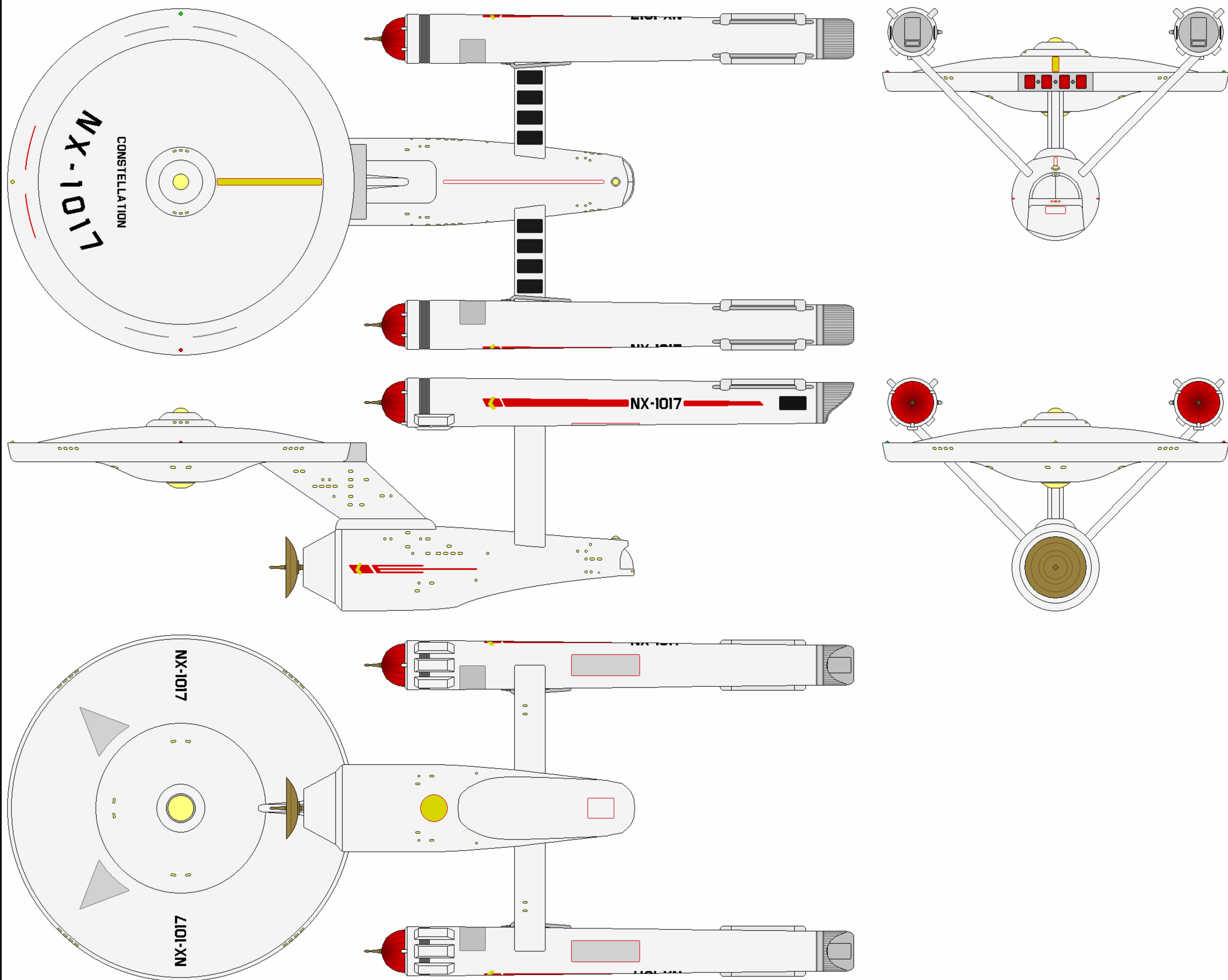

CATEGORY: HEAVY CRUISER TESTBED
 OPERATIONAL: 2238
 MODIFIED: 1 (FUSION TESTBED)

DIMENSIONS:
 LENGTH: 278.8 M
 BEAM: 114.1 M
 HEIGHT: 76.9 M
 MASS: 595,000 MT

TACTICAL: N/A

AUXILIARIES:
 - 2X LIGHT SHUTTLES
 - 2X SHUTTLEPODS
 - 1X WORK POD

PERFORMANCE:
 CRUISE: WARP 6 (OCU)
 MAX: WARP 8 (OCU)
 ENDURANCE: N/A

COMPLEMENT:
 CREW: VARIED FOR TESTING



CONSTELLATION DILITHIUM TESTBED AUTHORIZED CONSTRUCTION

THE FOLLOWING DECOMMISSIONED SHIP WAS AUTHORIZED BY FEDERATION COUNCIL RESOLUTION TO TAKE PART IN AND BE MODIFIED FOR TESTING REQUESTED BY STAR FLEET STAFF REQUIREMENT.

CONSTELLATION NX-1017

GENERAL INFORMATION

By 2238, the Federation's first natural dilithium source on Deneva was in the opening stages of full mining and refining of the most critical component of a truly efficient annihilation core, with Star Fleet's Project Starship a targeted recipient. The NX Constellation had the previous 4:1 matter/antimatter spicing compression fusion powerplant replaced by a custom-fitted dilithium-regulated antimatter reactor and the ship was formally re-activated (though not yet re-commissioned) as NX-1017.

The Bonaventure flight tests had determined the optimum nacelle placement for a resonance-free flight test and the new dual PB-31s were placed in positions elevated and further back than the PB-30As utilized during the fusion testing phase. The pylons were reshaped and lengthened, as was the saucer's interconnecting dorsal, which added considerable internal volume for machinery, laboratories, and workspaces. The Constellation remained an experimental flight platform, so was equipped with defensive and navigational deflectors, but no weapons.

The test runs were considered successful, a major confidence boost for the collaborating teams. As a result, the Republic was towed into the refit yard to closely track the changes that would be necessary to upgrade the remaining Horizons to similar standards. Concurrently, a new-build prototype (Constitution) was ordered, as there was considerable faith that the ships were far more capable than had been envisioned necessary in 2210, and thus the expense of greater numbers would provide far more utility.

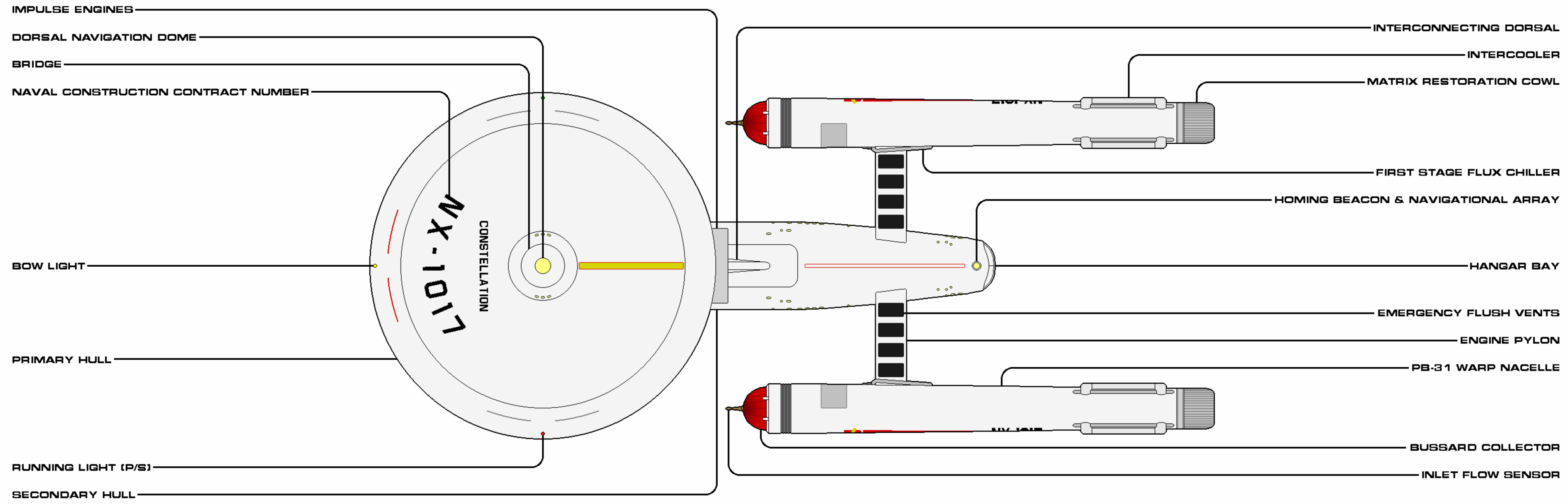
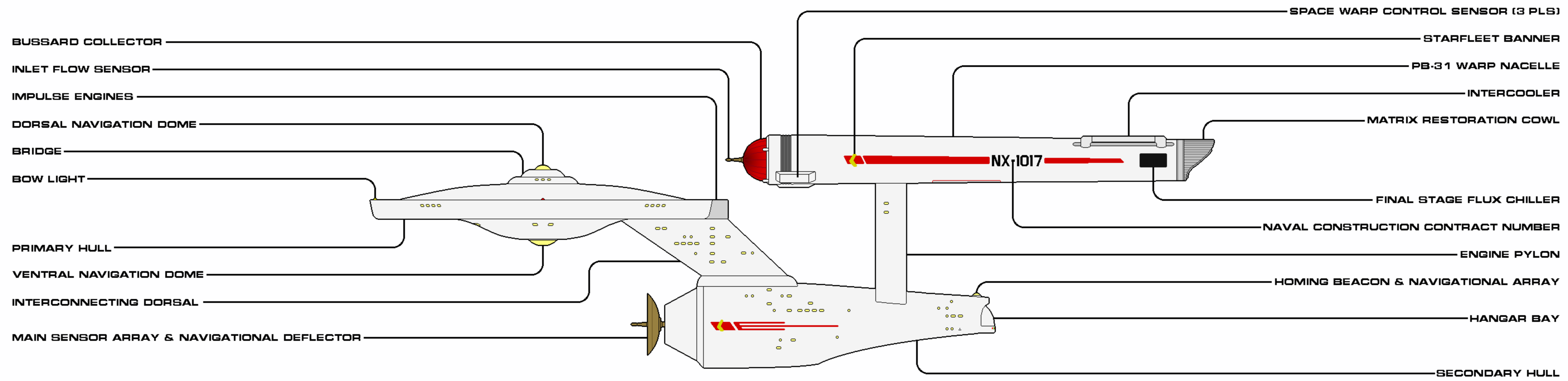

SHEET 1 OF 2

CLASS	CONSTELLATION	CATEGORY	DILITHIUM TESTBED
VARIANT	NA	MODIFIED	2238
LENGTH	278.8 M	BEAM	114.1 M
HEIGHT	16.9 M	MASS	595,000 MT
OPERATIONAL	1	RELEASE DATE	2001.30

Authorized for release by Star Fleet Bureau of Starship Construction

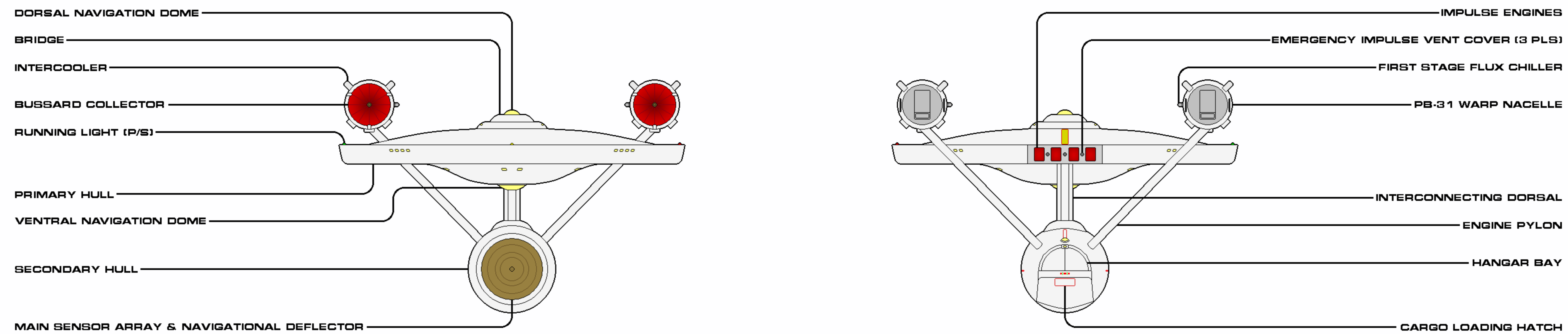
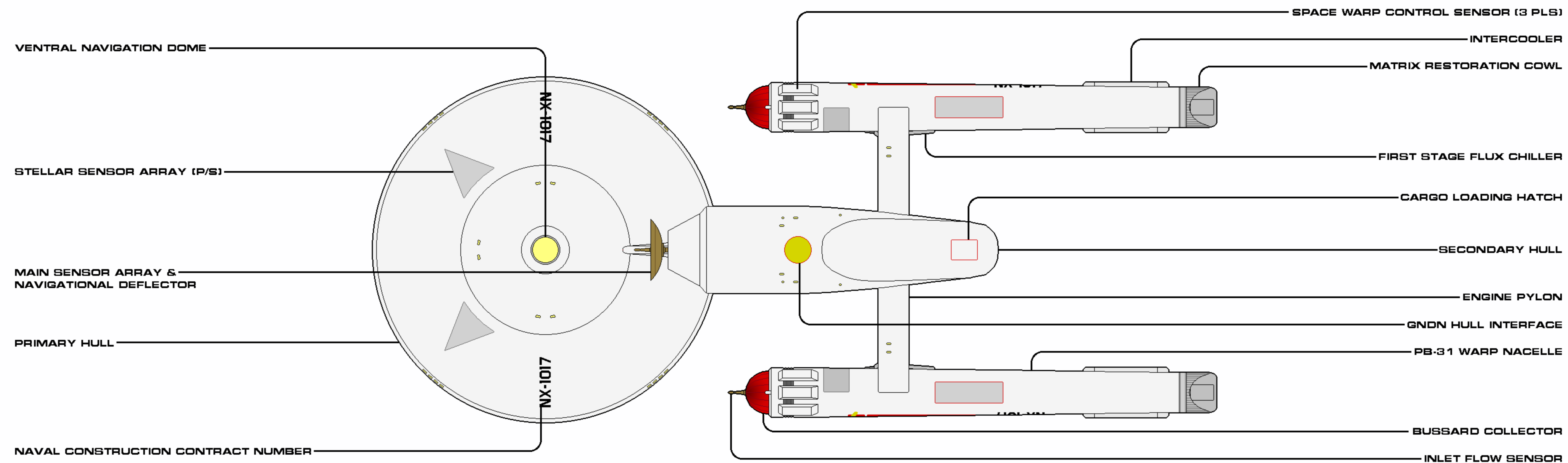

SHEET 2 OF 2

CLASS	CONSTELLATION	CATEGORY	DILITHIUM TESTBED
VARIANT	N/A	MODIFIED	2238
LENGTH	278.8 M	BEAM	114.1 M
HEIGHT	16.9 M	MASS	595,000 MT
OPERATIONAL	1	RELEASE DATE	2001.30

Authorized for release by Star Fleet Bureau of Starship Construction

REPUBLIC PROTOTYPE

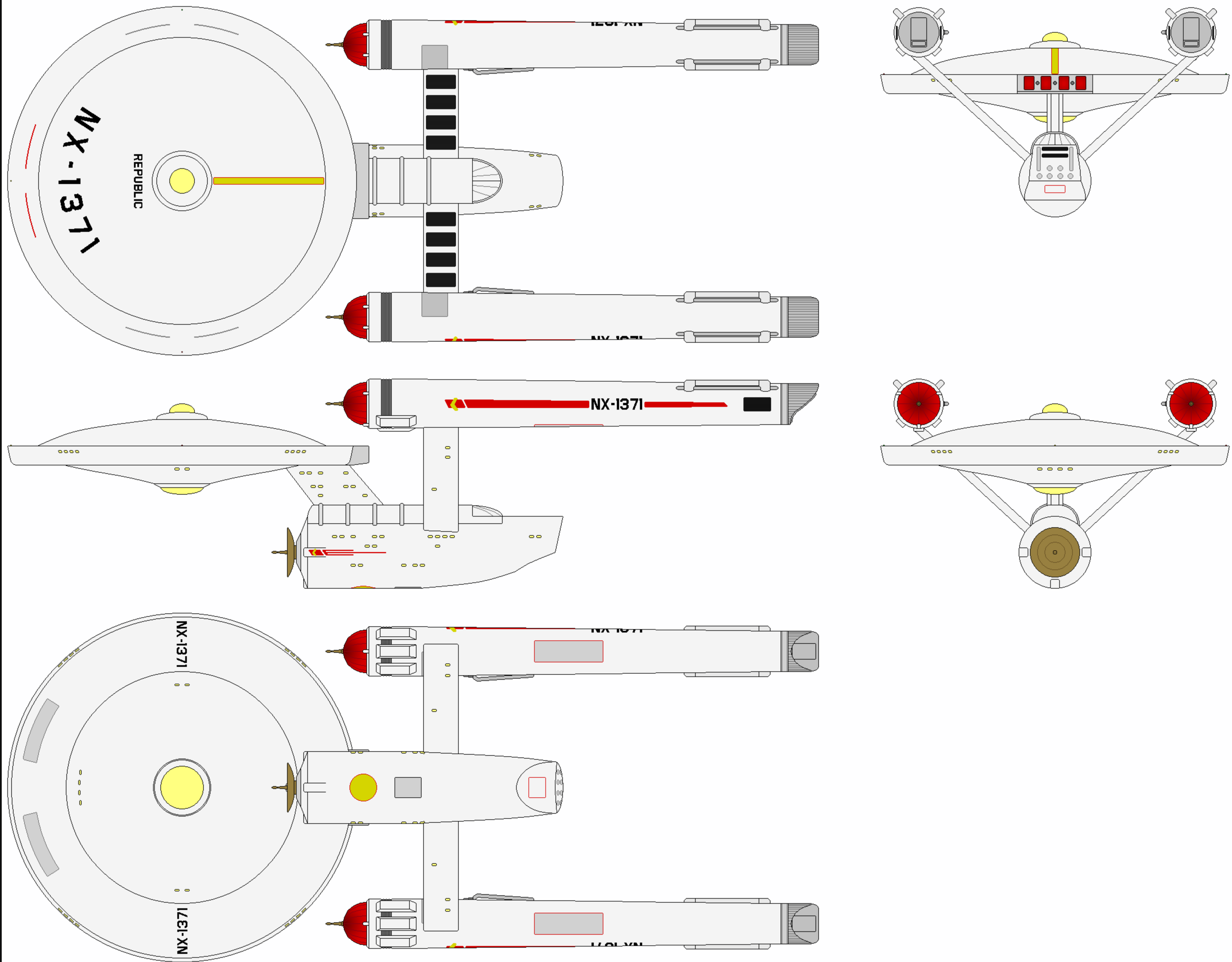

CATEGORY: HEAVY CRUISER PROTOTYPE
 OPERATIONAL: 2238
 MODIFIED: 1 (ARCHON SUBCLASS)

DIMENSIONS:
 LENGTH: 265.2 M
 BEAM: 114.1 M
 HEIGHT: 68.3 M
 MASS: 599,100 MT

TACTICAL: N/A

AUXILIARIES:
 - 2X LIGHT SHUTTLES
 - 2X SHUTTLEPODS
 - 1X WORK POD

PERFORMANCE:
 CRUISE: WARP 6 (OCU)
 MAX: WARP 8 (OCU)
 ENDURANCE: N/A

COMPLEMENT:
 CREW: VARIED FOR TESTING



REPUBLIC PROTOTYPE
AUTHORIZED CONSTRUCTION

THE FOLLOWING DECOMMISSIONED SHIP WAS AUTHORIZED BY FEDERATION COUNCIL RESOLUTION TO TAKE PART IN AND BE MODIFIED FOR TESTING REQUESTED BY STAR FLEET STAFF REQUIREMENT.

REPUBLIC NX-1371

GENERAL INFORMATION

With the success of Constellation's flight runs, ex-Republic was brought into the refit yards as a final examination of the feasibility of converting other Horizons to the new heavy cruiser specifications. She had been inactive since the conflagration in 2220 and floating lifeless without the forward command saucer and mounting structure. The yard completely stripped what remained of her internal spaces and a dilithium-regulated antimatter reactor (similar to that of her sister) was embedded in her newly-redesigned engineering spaces. The yard workers leveled off the upper slope of the secondary hull, placing a domed structure in its place-ribbed for added stress tolerance-with a limited-capacity shuttlebay immediately aft of amidships.

Pylons supporting PB-31s were gamma-welded into the Bonaventure-proven configuration for maximal warp efficiency and a pre-manufactured custom saucer, with a less extensive interconnecting dorsal (in comparison to the Constellation) mated in the upper forward position. The profile, now suggesting only slightly her Horizon origin, gave the Republic a personality not just re-designed, but reborn. Where aficionados of the older class described a ship always surging forward even while at rest, the Republic was said to project a grace of stately power, seemingly always in a peaceful condition even when moving at high warp.

In 2238 she began her flight tests, unarmed but well defended with a conformal forcefield and a large deflector dish forward of the secondary hull. Astern, the subspace displacement monitor array relayed the detected warp field results not just to engineering consoles within Republic, but also to the trailing starship and the operations office back at the yard.

The Republic design team was rather confident that, of the two differing ships, theirs was the one that would seize the production standard. After all, if the economics bore out, there were at least ten more ships that were ready to be converted, and the Republic project detailed just how that was to be done.

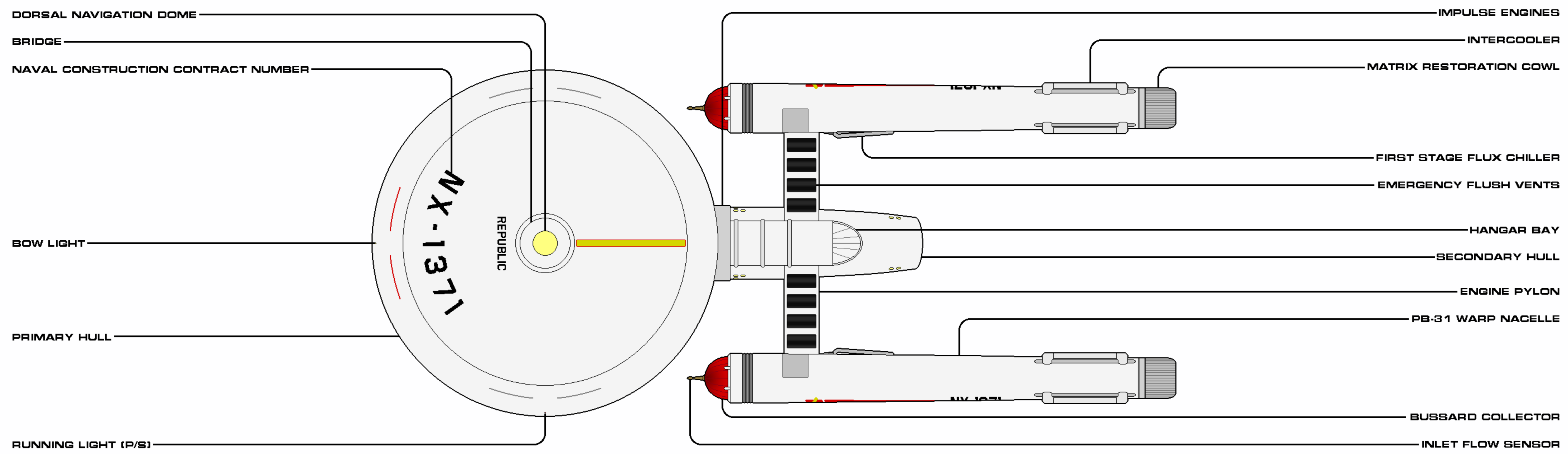
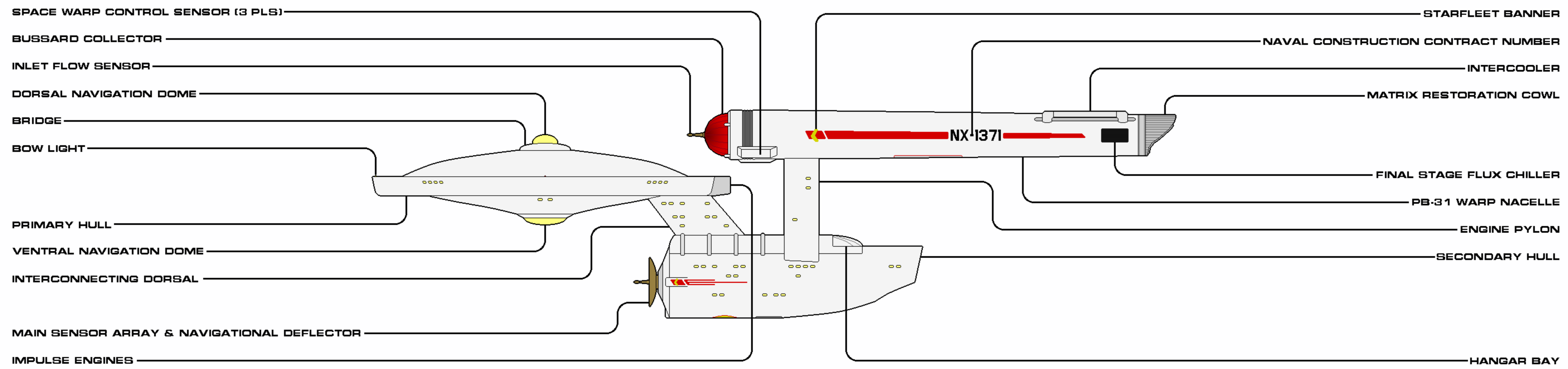

SHEET 1 OF 2

CLASS	REPUBLIC	CATEGORY	PROTOTYPE CRUISER
VARIANT	NA	MODIFIED	2250
LENGTH	200.2 M	BEAM	114.1 M
HEIGHT	60.3 M	MASS	500,000 MT
OPERATIONAL	1	RELEASE DATE	2001.30

Authorized for release by Star Fleet Bureau of Starship Construction

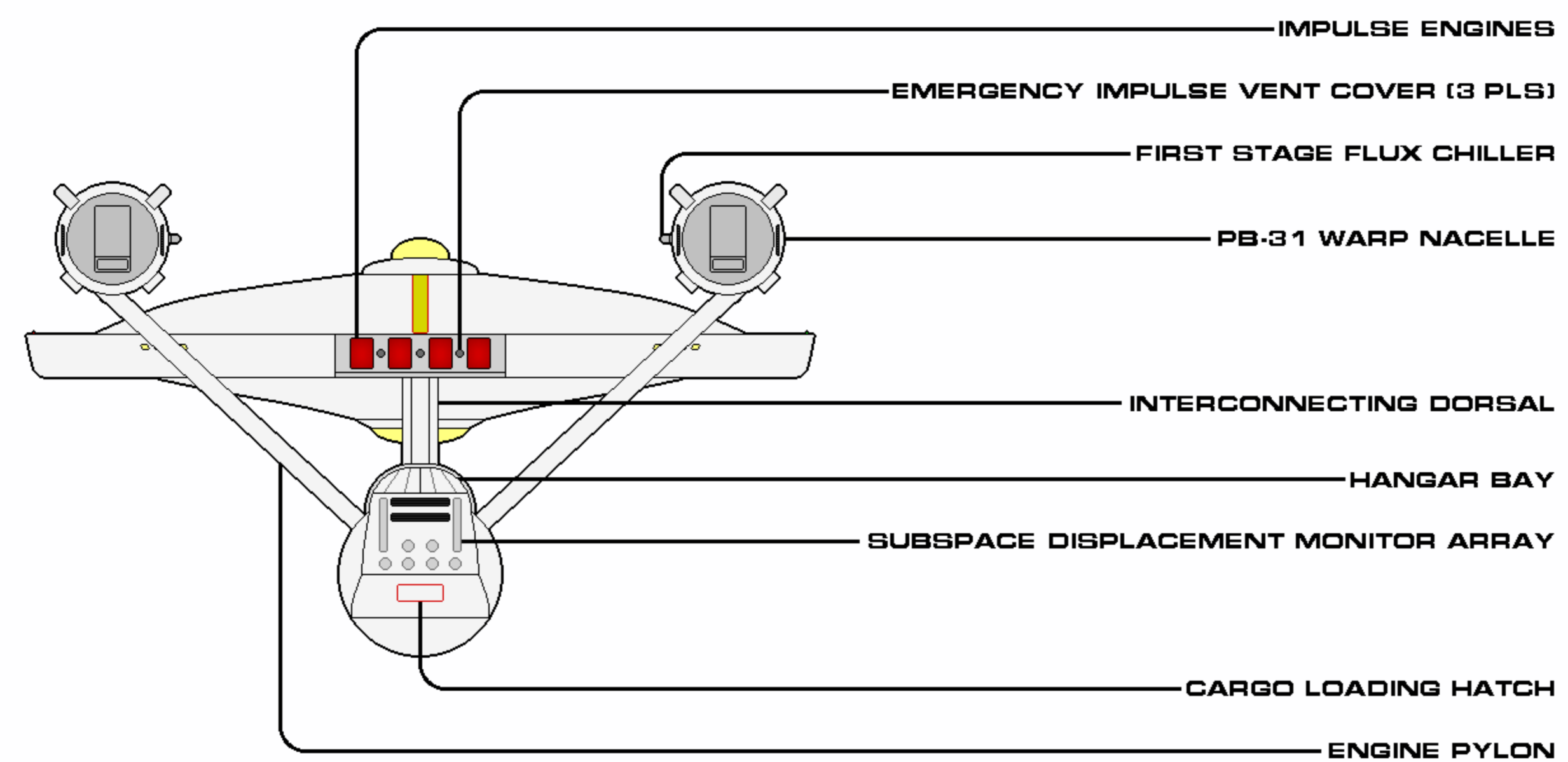
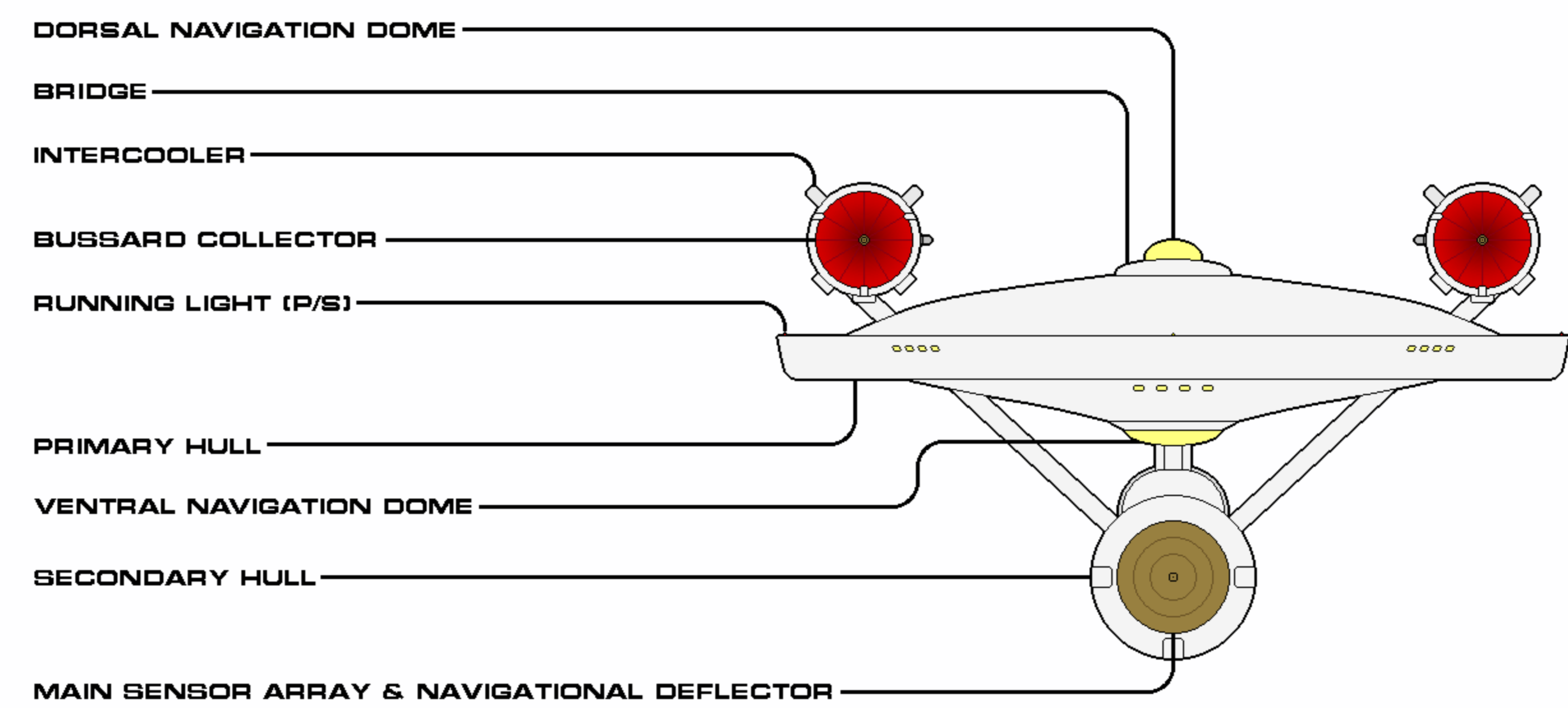
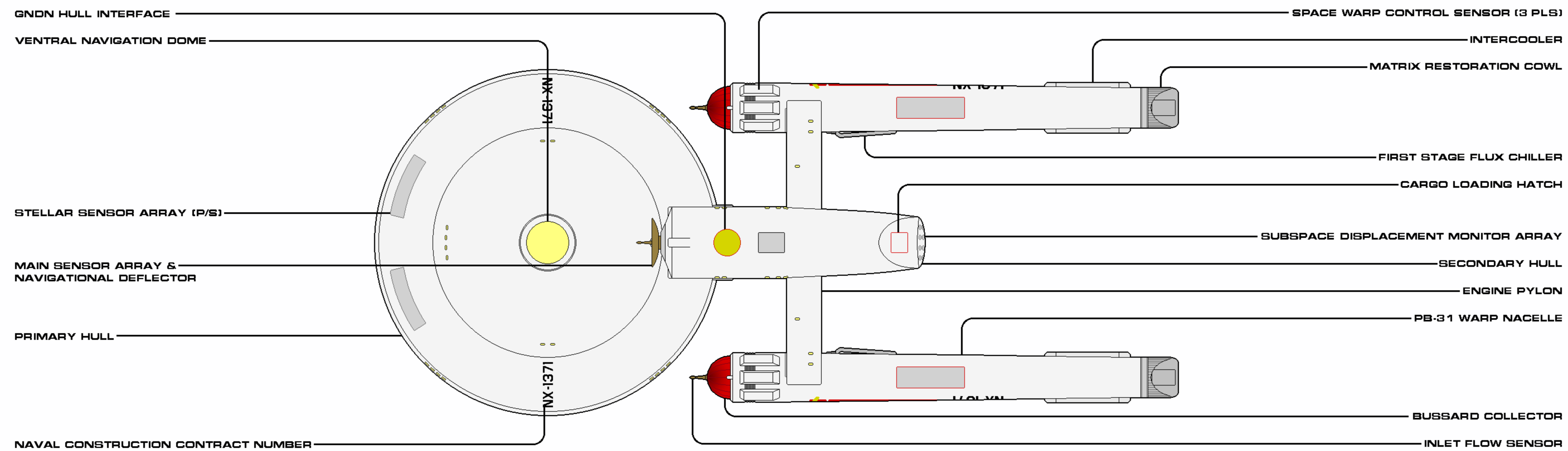

SHEET 2 OF 2

CLASS	REPUBLIC	CATEGORY	PROTOTYPE CRUISER
VARIANT	N/A	MODIFIED	2238
LENGTH	265.2 M	BEAM	114.1 M
HEIGHT	68.3 M	MASS	599,100 MT
OPERATIONAL	1	RELEASE DATE	2001.30

Authorized for release by Star Fleet Bureau of Starship Construction



CONSTITUTION PRODUCTION PROTOTYPE

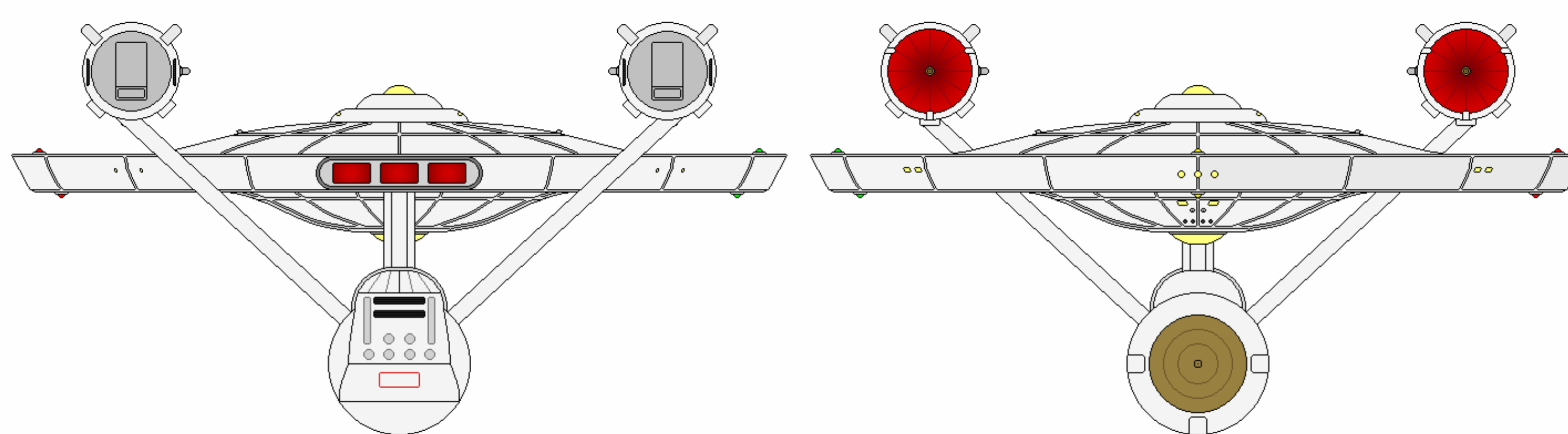
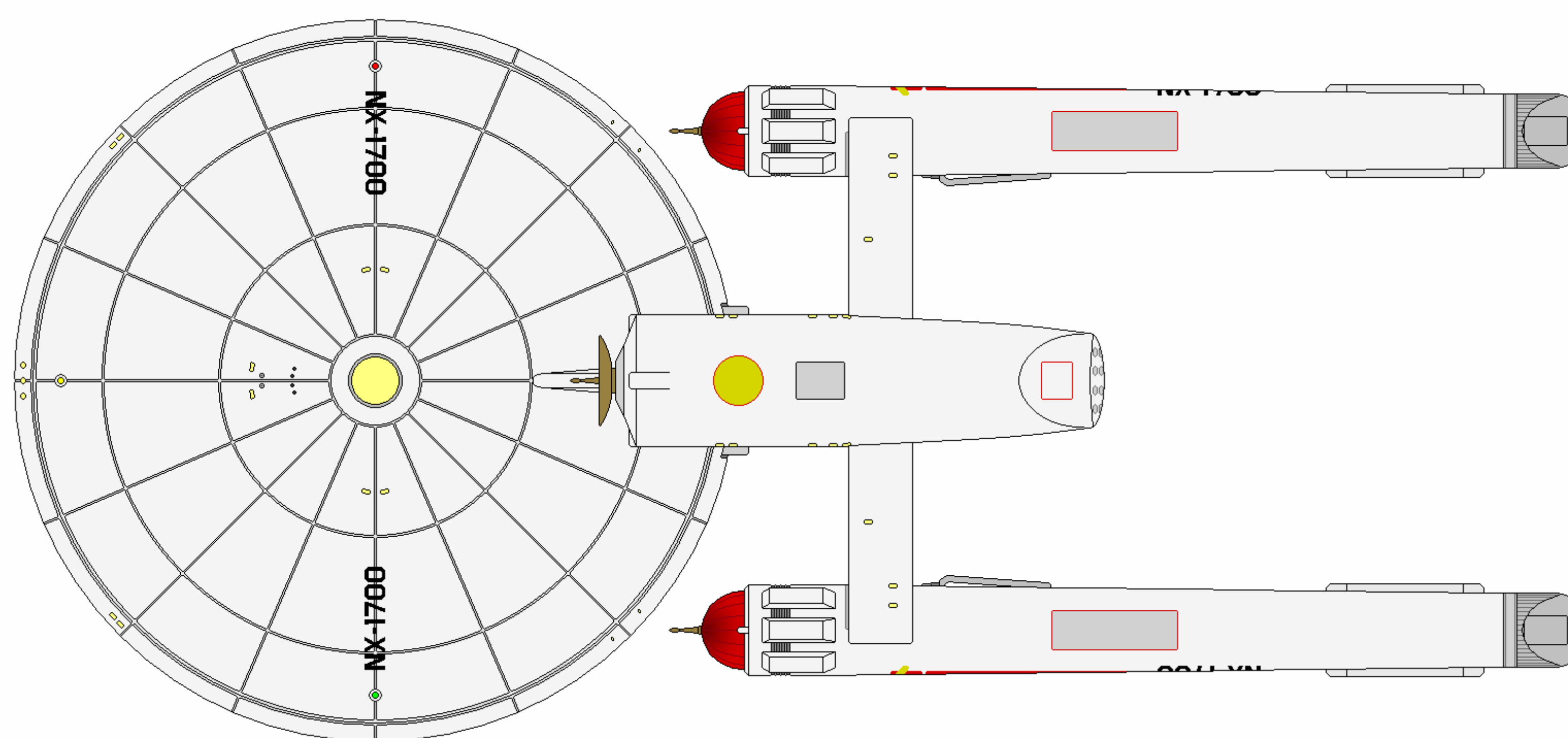
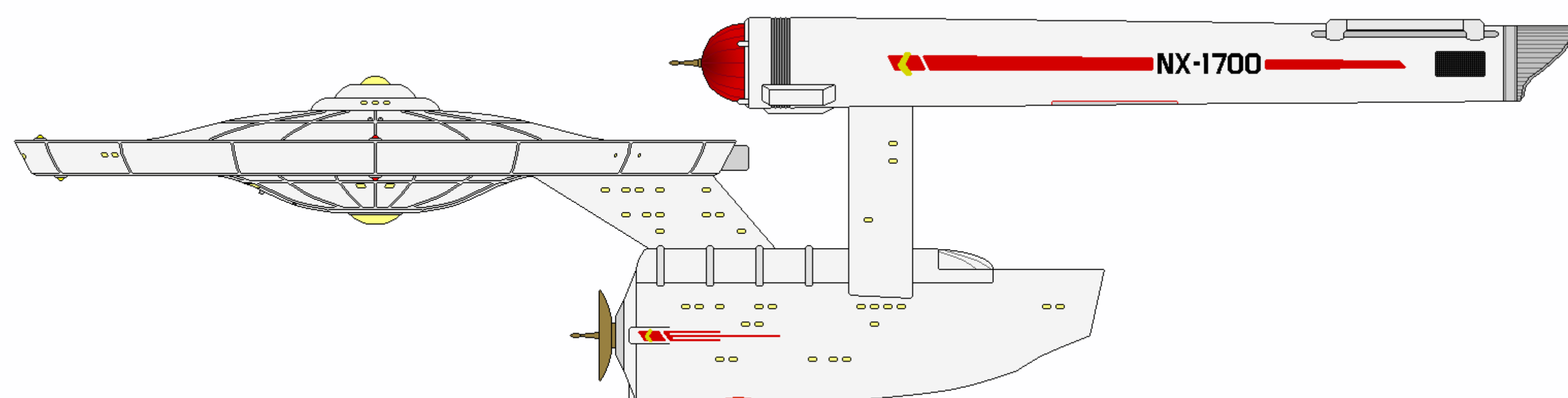
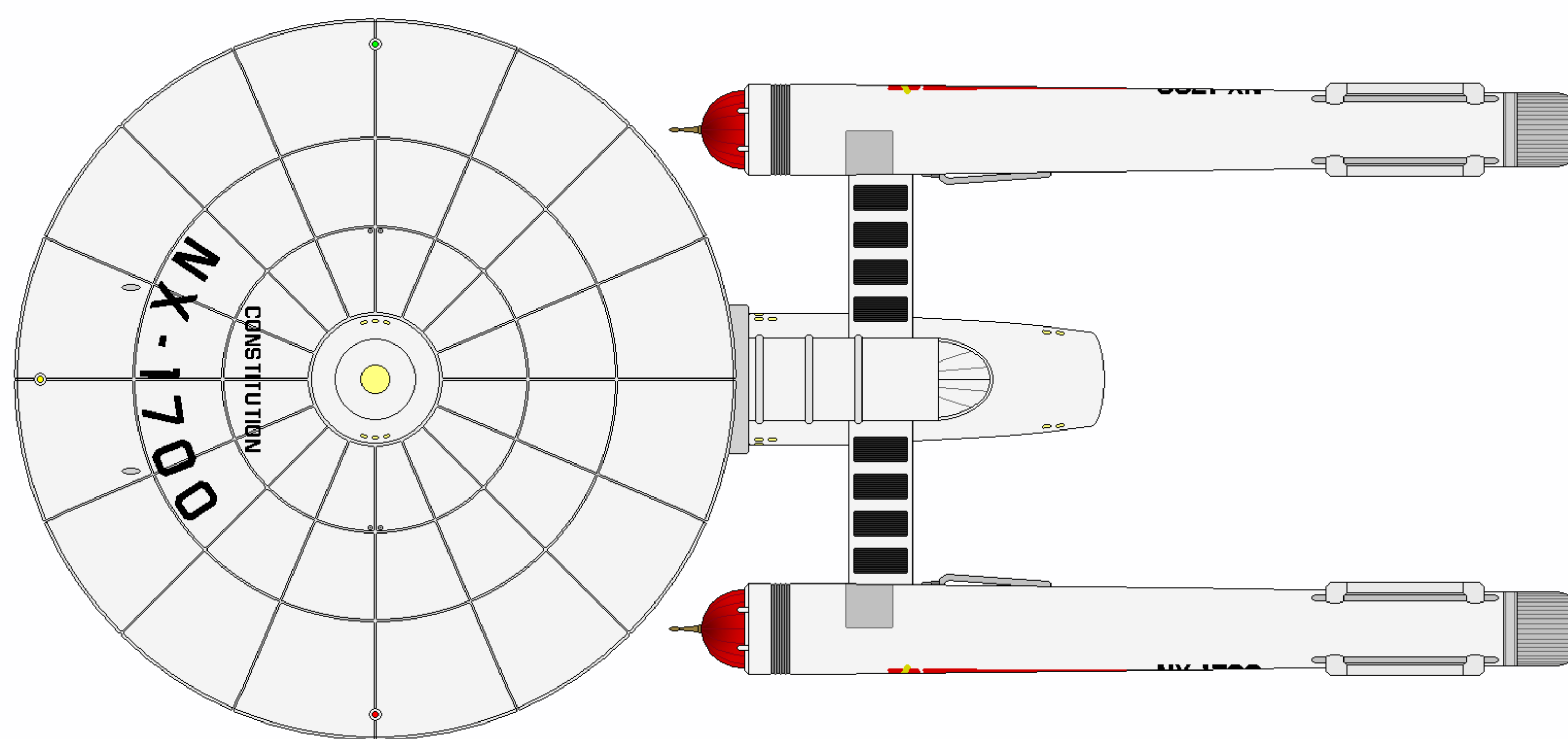



CONSTITUTION PRODUCTION PROTOTYPE GENERAL INFORMATION (CONTINUED)

USS Saint Louis were the first to arrive and Garth, using ingenious hit-and-run tactics, prevented the Klingons from using their increasingly numerical advantage to concentrate their fire upon the Star Fleet blockade. With the arrival of two Baton Rouge cruisers and four Saladin destroyers a week later, the numbers changed, concluding the First Battle of Axanar in the Federation's favor.

Captain Garth returned the victorious Constitution to the test team, but as she transited to Earth, a vengeful Klingon force ambushed the lone vessel in the vicinity of Lea. Once again, the ship bravely fought off her attackers but absorbed significant damage. After a few months, shipyard repairs were completed and follow-on trial runs scheduled. However, an emergency signal for help received from the former Federation colonists still surviving on nearby Donatu V prompted Star Fleet to finally send help in strength in February 2242. The engagement with the Klingon conquerors led to the dramatic loss of cruisers USS Endeavor and USS Yorkshire. Star Fleet retasked Constitution, still uncommissioned, with assisting the surviving task force. Upon her arrival, she promptly engaged a running series of Klingon D5 and D6 battle cruisers almost single-handedly, buying time for the main contingent of Star Fleet reinforcements to arrive.

The again-tremendously damaged starship limped back to the development yards for another three years in a cold status, but supplying an equally tremendous amount of combat data upon which to improve damage repair techniques and combat effectiveness. This information was instrumental in the development of the ordered vessel, Enterprise (NCC-1701), already engaged in initial vehicle frame layout.

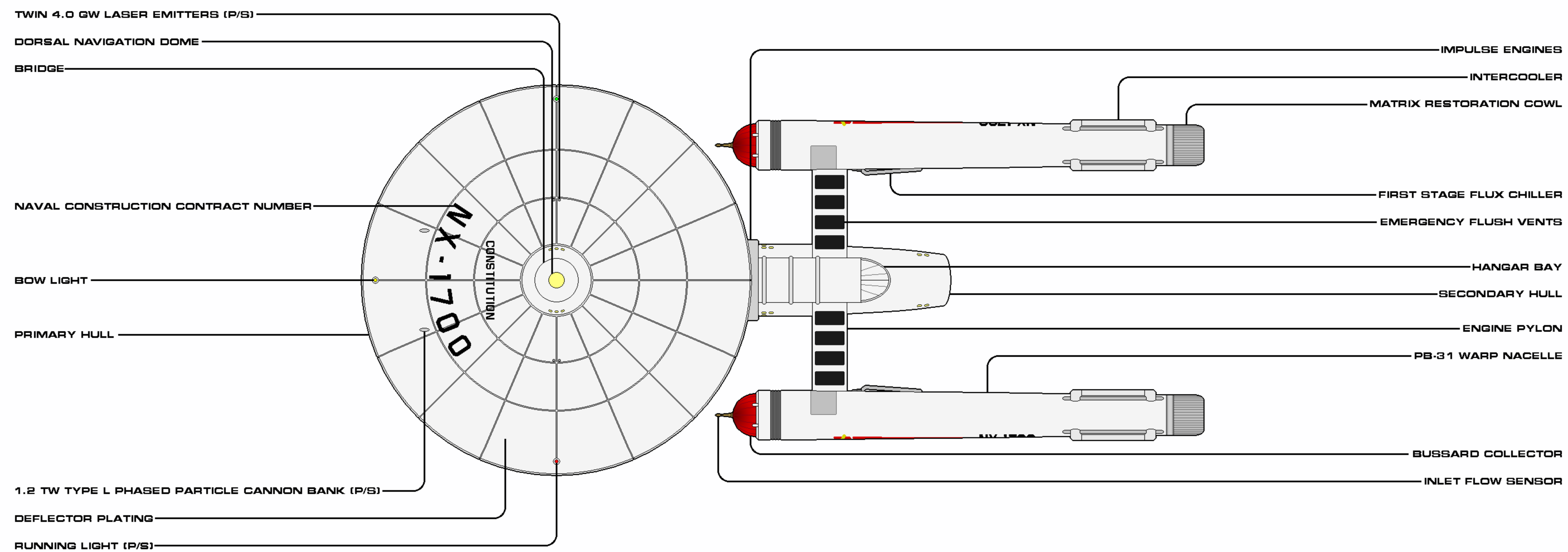
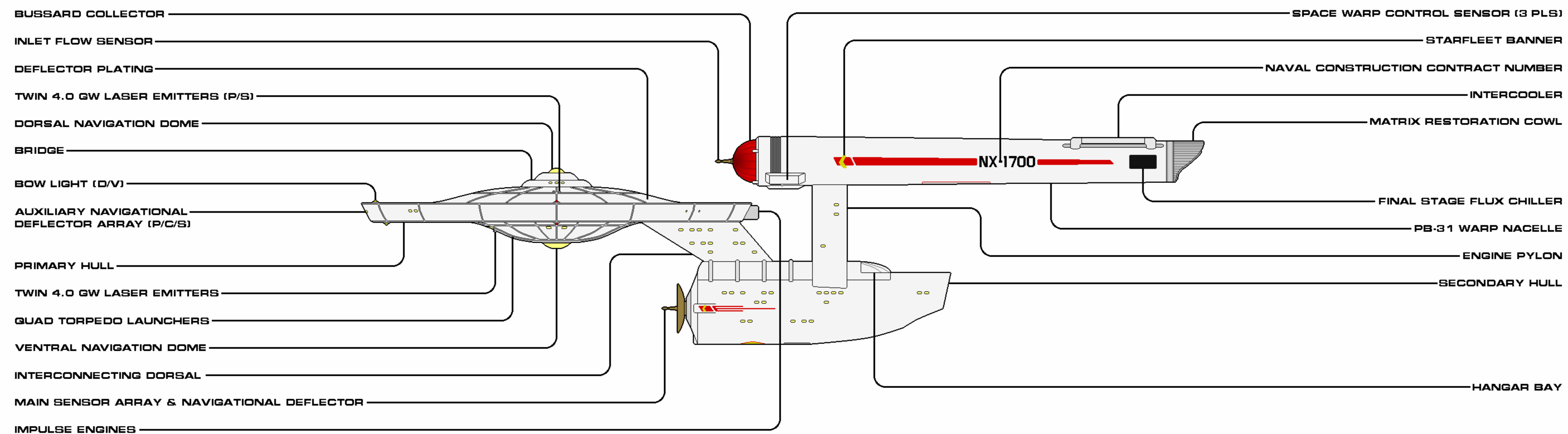

SHEET 1 OF 2

CLASS	CONSTITUTION	CATEGORY	PROTOTYPE CRUISER
VARIANT	N/A	CONSTRUCTED	2242
LENGTH	278.1 M	BEAM	122.0 M
HEIGHT	68.3 M	MASS	538,400 MT
OPERATIONAL	1	RELEASE DATE	2002.05

Authorized for release by Star Fleet Bureau of Starship Construction

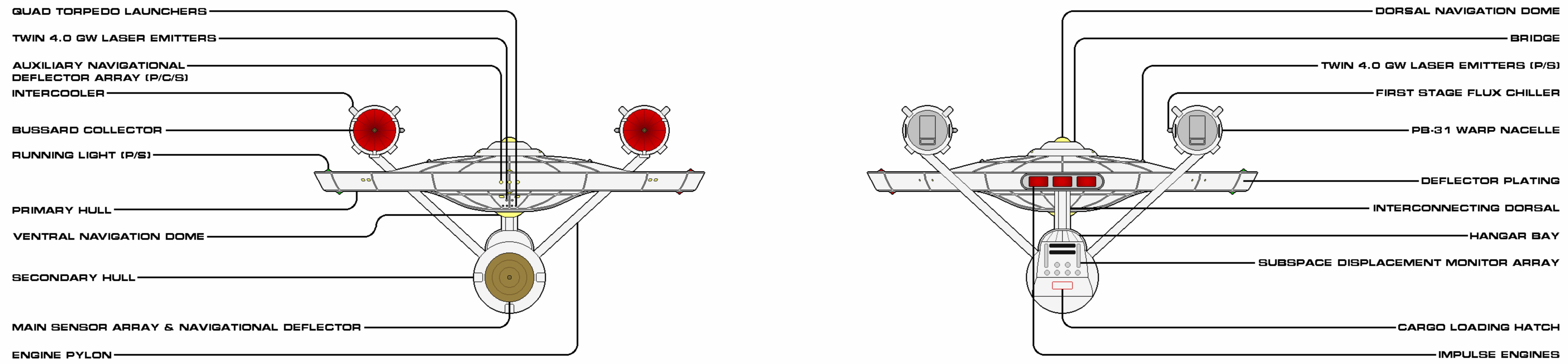
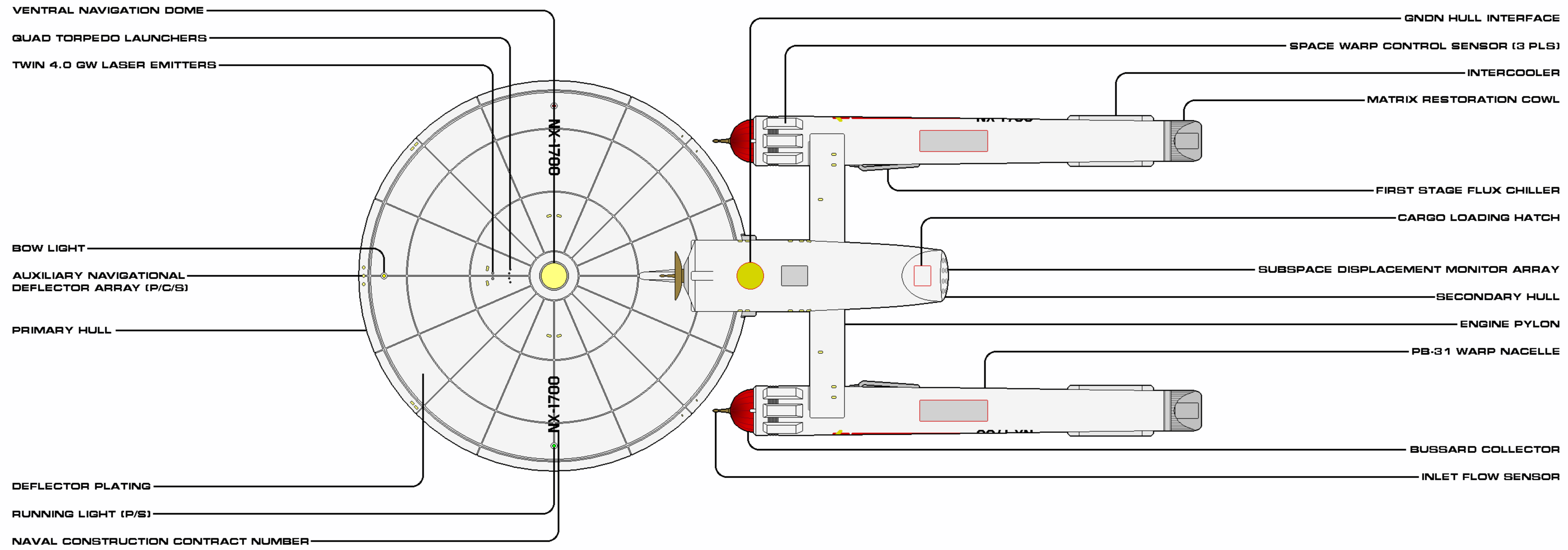

SHEET 2 OF 2

CLASS CONSTITUTION	CATEGORY PROTOTYPE CRUISER
VARIANT N/A	CONSTRUCTED 2242
LENGTH 278.1 M	BEAM 122.0 M
HEIGHT 68.3 M	MASS 598,400 MT
OPERATIONAL 1	RELEASE DATE 2002.05

Authorized for release by Star Fleet Bureau of Starship Construction



ENTERPRISE PRODUCTION PROTOTYPE

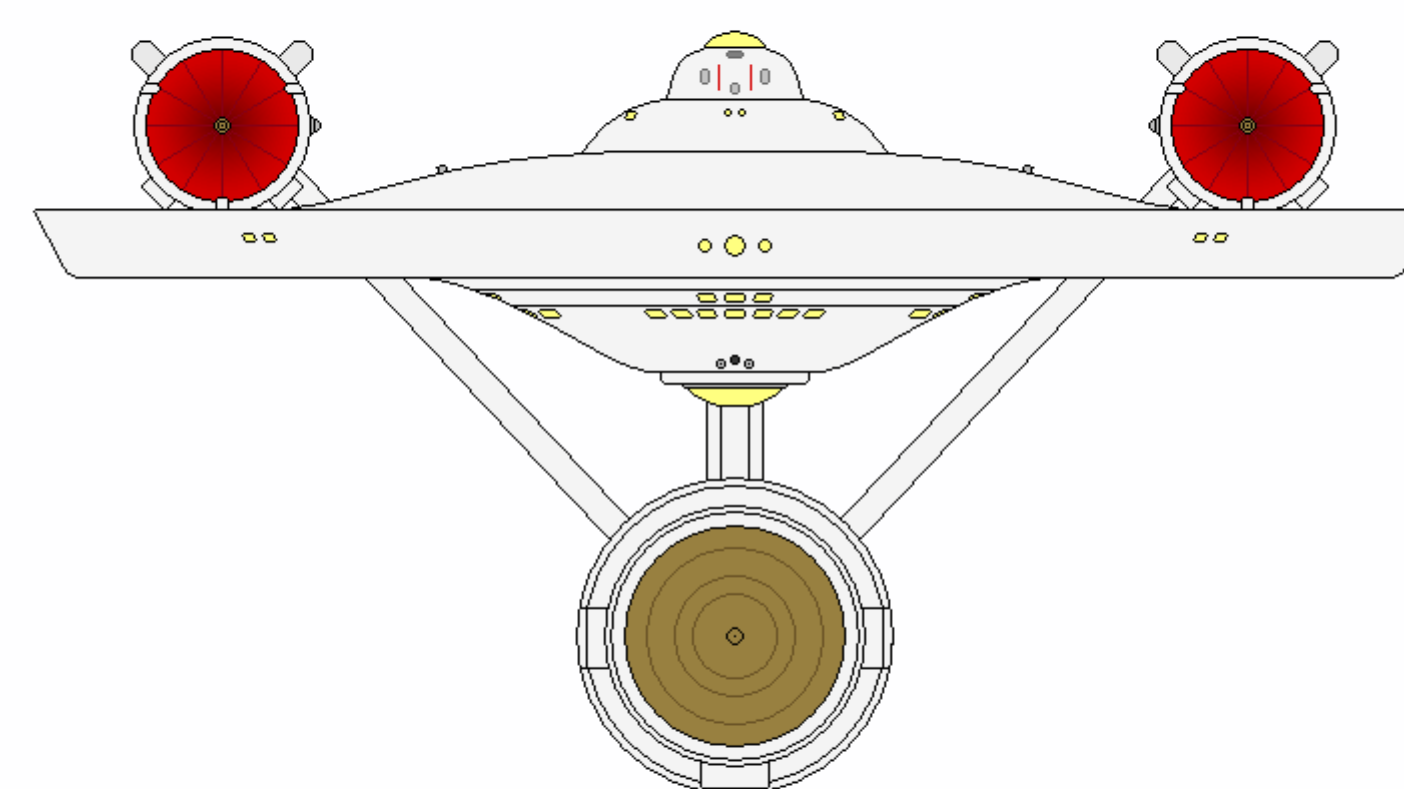
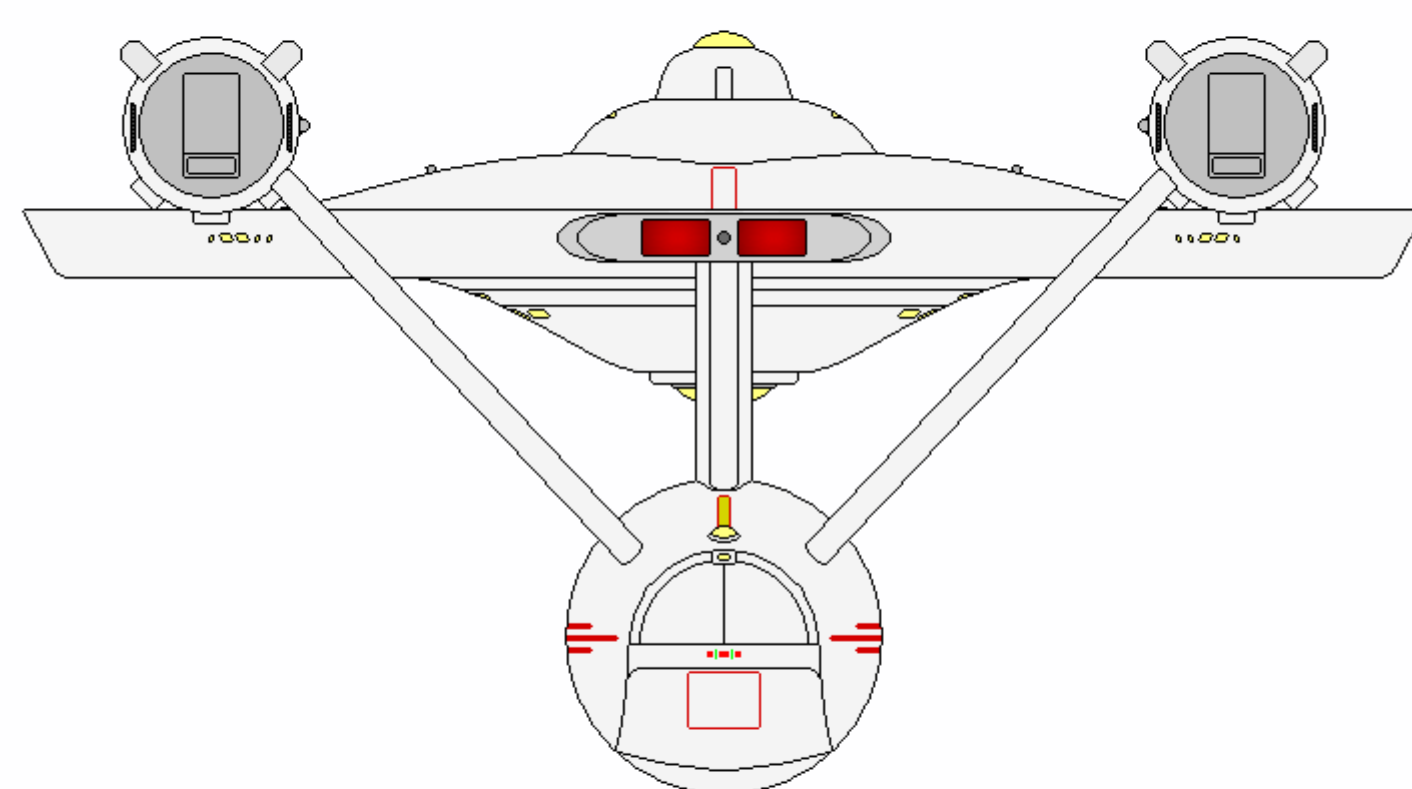
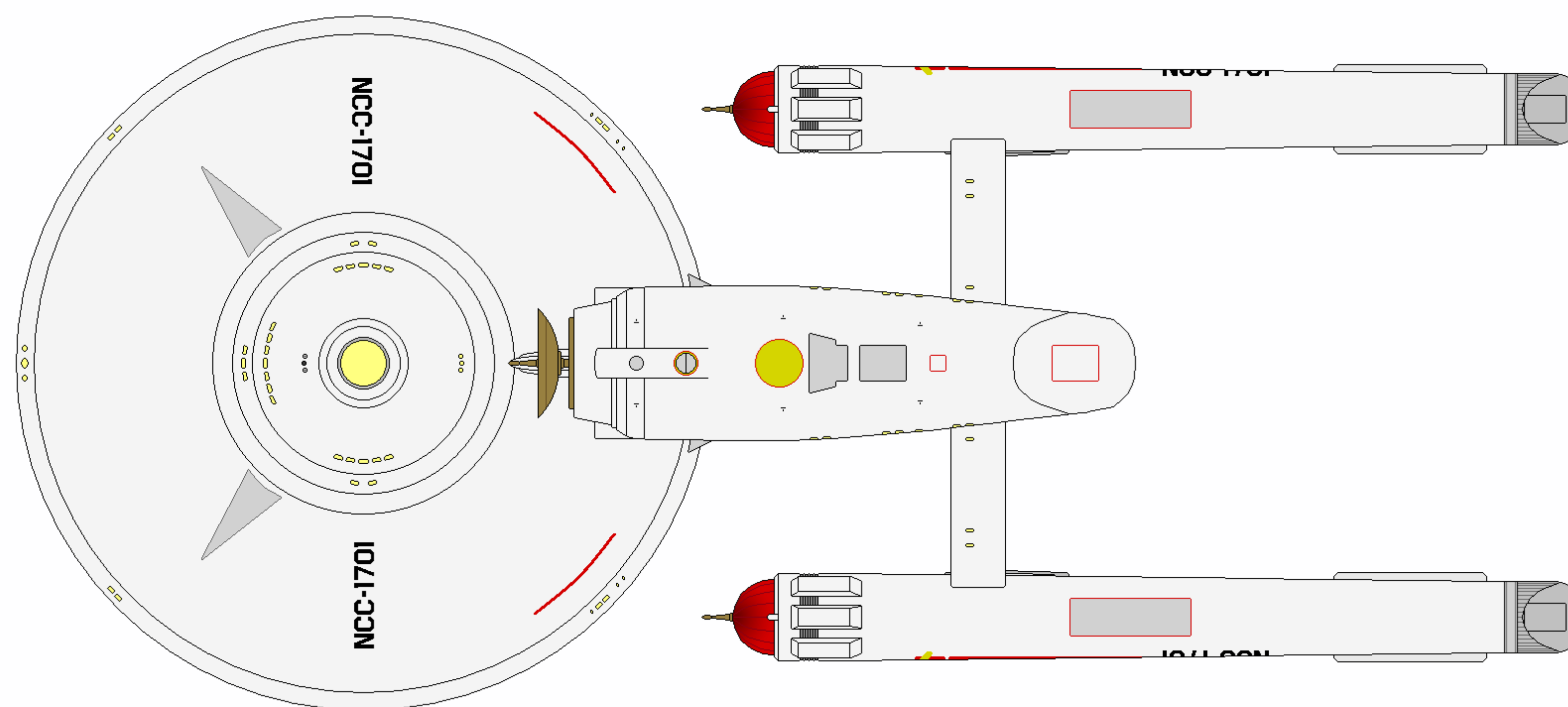
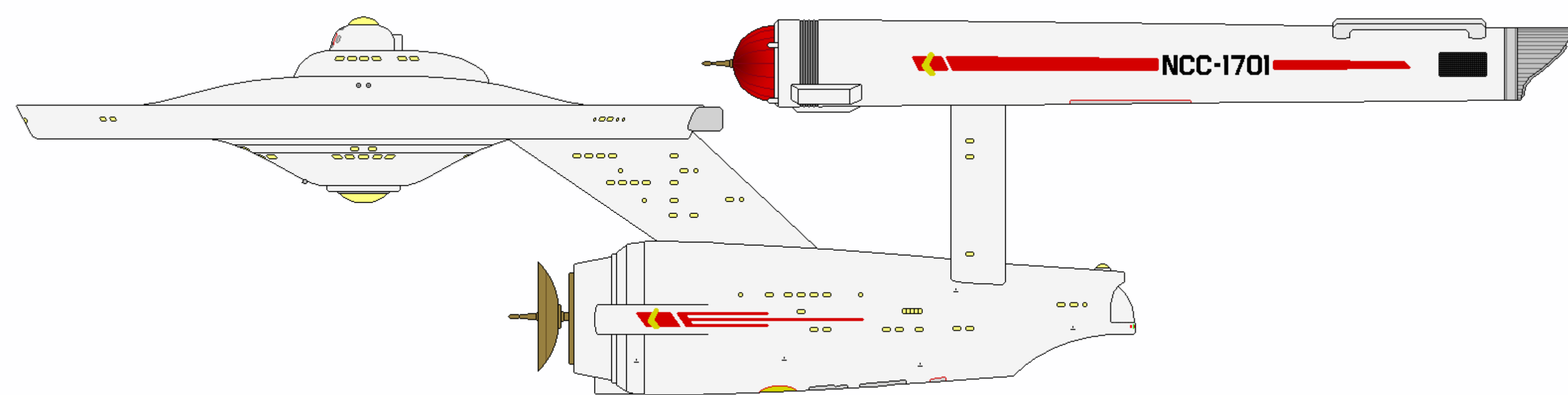
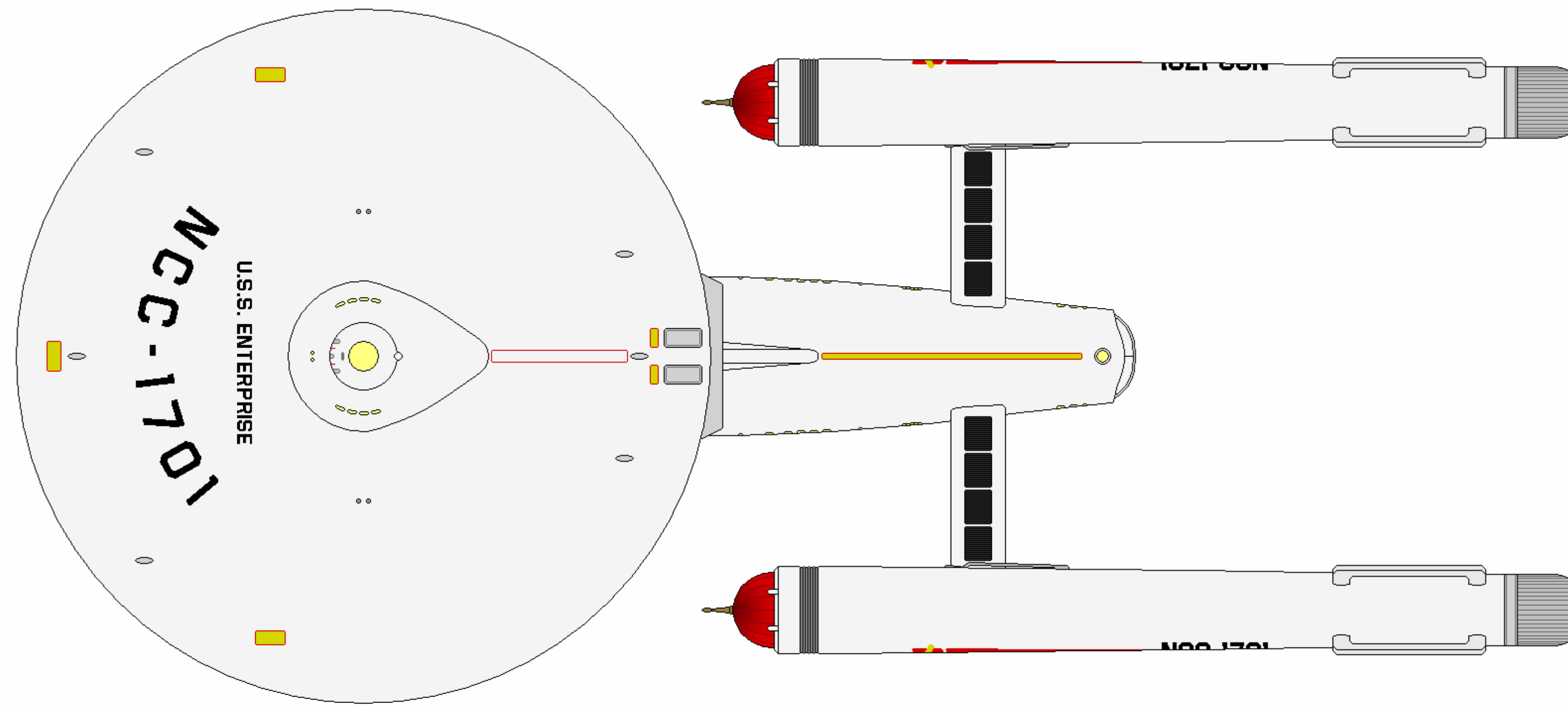



ENTERPRISE PRODUCTION PROTOTYPE

CATEGORY: HEAVY CRUISER PRODUCTION PROTOTYPE
 OPERATIONAL: 2245 - 2251
 CONSTRUCTED: 11

DIMENSIONS:		TACTICAL:
LENGTH:	288.6 M	- 6X 4.0 GW LASER EMITTERS
BEAM:	127.1 M	- 4X 1.2 TW TYPE L PHASED PARTICLE CANNONS
HEIGHT:	72.6 M	- 2X 1.4 TW TYPE M PHASED PARTICLE CANNONS
MASS:	679,300 MT	- 1X MEDIUM TORPEDO TUBE

PERFORMANCE:		- 1-LAYER CONFORMAL FORCEFIELD
CRUISE:	WARP 6 (OCU)	- 1X PRIMARY NAVIGATIONAL DEFLECTOR
MAX:	WARP 8 (OCU)	- 3X AUXILIARY NAVIGATIONAL DEFLECTORS
ENDURANCE:	5 YEARS	

COMPLEMENT:		AUXILIARIES:
OFFICERS:	69	- 1X HEAVY SHUTTLE
ENLISTED:	392	- 2-4X LIGHT SHUTTLES
		- 4X SHUTTLEPODS
		- 4X WORK PODS
		- VARIOUS SPECIAL ENVIRONMENT/TACTICAL CRAFT

AUTHORIZED CONSTRUCTION

THE FOLLOWING SHIPS OF THE ABOVE CLASS WERE AUTHORIZED AS PART OF THE FEDERATION STAR FLEET BY FEDERATION COUNCIL APPROPRIATION.

USS ENTERPRISE	NCC-1701	USS HOOD	NCC-1707
USS FARRAGUT	NCC-1702	USS INTREPID	NCC-1708
USS LEXINGTON	NCC-1703	USS VALIANT	NCC-1709
USS YORKTOWN	NCC-1704	USS KONGO	NCC-1710
USS EXCALIBUR	NCC-1705	USS POTEMKIN	NCC-1711
USS EXETER	NCC-1706		

GENERAL INFORMATION

Project Starship, initiated in the century's first decade, had a plan: take the Horizon secondary hull and transform it into an advanced generation heavy cruiser design. To do this, two ships from the Horizon class—USS Constellation (NCC-1017, Advance Flight II) and USS Republic (NCC-1371, Archon subclass)—were assigned as test vessels for the development project. Constellation was the sole recipient of the various redesign iterations in the project's early years, with the endgame having the ship be the first to meet the final production standards. Republic would be held in reserve until that standard was established and then upgraded, with every effort meticulously catalogued to develop the procedures necessary to transform the rest of the Horizon type.

When the design team firmly established the exact parameters for the dilithium-regulated antimatter reactor and the proper placement for the warp nacelles, their plans were approved and signed off to the Republic's reconstruction crew. This second team came to a quick and significant realization: the Constellation had gone through so many yard periods to install new equipment and reinforce this hull section or that structural member, that there was really no point in tearing apart each and every Horizon to meet the exact same standards. After all, the intent was to adapt a given Horizon hull in order to save both time and costs and come out with a better ship than had gone in. Therefore, some aspects of the Constellation were streamlined with the Republic's redesign to ensure that only the necessary components, members, and equipment were overhauled. The result was a ship that was noticeably different externally from the Constellation, but had the same performance characteristics as the dilithium testbed.

However, time had marched on and an independent commission on Fleet strength strongly suggested it was not efficient nor logical to depend on upgrading a Horizon fleet that was nearly 15 years older than originally envisioned for the overhaul. Instead, a production run of 12 newbuild ships was authorized, based upon the Republic prototype. As previously detailed, the prototype Constitution faced unexpected combat challenges that tested her capabilities to the extreme, and provided valuable and informative data for improvements. What was to be the first of the production run vessels of Project Starship would now herself be a production prototype. While the Constitution was undergoing both repairs and upgrades, the Enterprise was in a nearby drydock going through her own keel-to-yardarm construction to very similar standards.



ENTERPRISE PRODUCTION PROTOTYPE GENERAL INFORMATION (CONTINUED)

In late 2244 and into 2245, Project Starship had four vessels undergoing operational overhauls, repairs, or construction: Constellation, Republic, Constitution, and Enterprise. Each was slightly different than the other and it was not yet clear which would be the production standard for the remaining 10 authorized ships and, consequently, the class ship. Even before commissioning, Enterprise was tasked with a covert mission in the direction of the Romulan border (of which full details are yet to be released), a strong sign of the confidence Captain Robert April, the project's final and longest serving manager, had in her capabilities. He formally took command of USS Enterprise (NCC-1701) on her commissioning day, April 11, 2245, with USS Constitution (NCC-1700) being commissioned mere days later. USS Republic (NCC-1371) and USS Constellation (NCC-1017) would be re-commissioned in May and June respectively; each of the four had "Project Starship" emblazoned in place of a class name on their respective dedication plaques. Ride-along evaluation teams from Project Starship critiqued each vessel during their post-commissioning crew familiarization work-ups, checking or striking off closely-held line items on their PADDs.

Before the end of the year, the decision was made: the production standard would be that of the Enterprise. In a concession to Constitution's original authorization, the class would take on her name. USS Farragut (NCC-1702), in late 2247, would be the first commissioned Constitution heavy cruiser with the class name on her own dedication plaque.

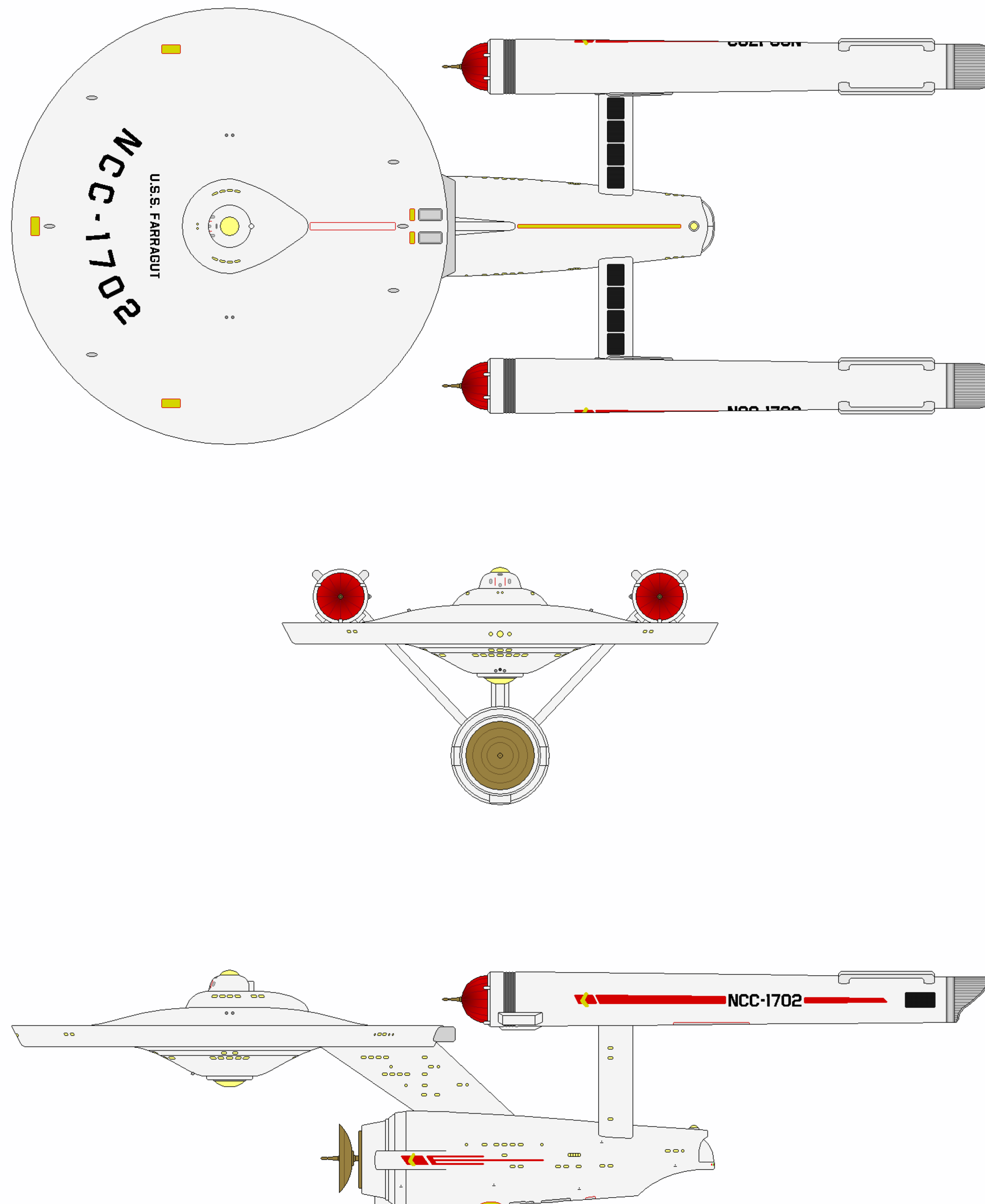

USS Farragut, the first ship to be commissioned as a member of the Constitution class.

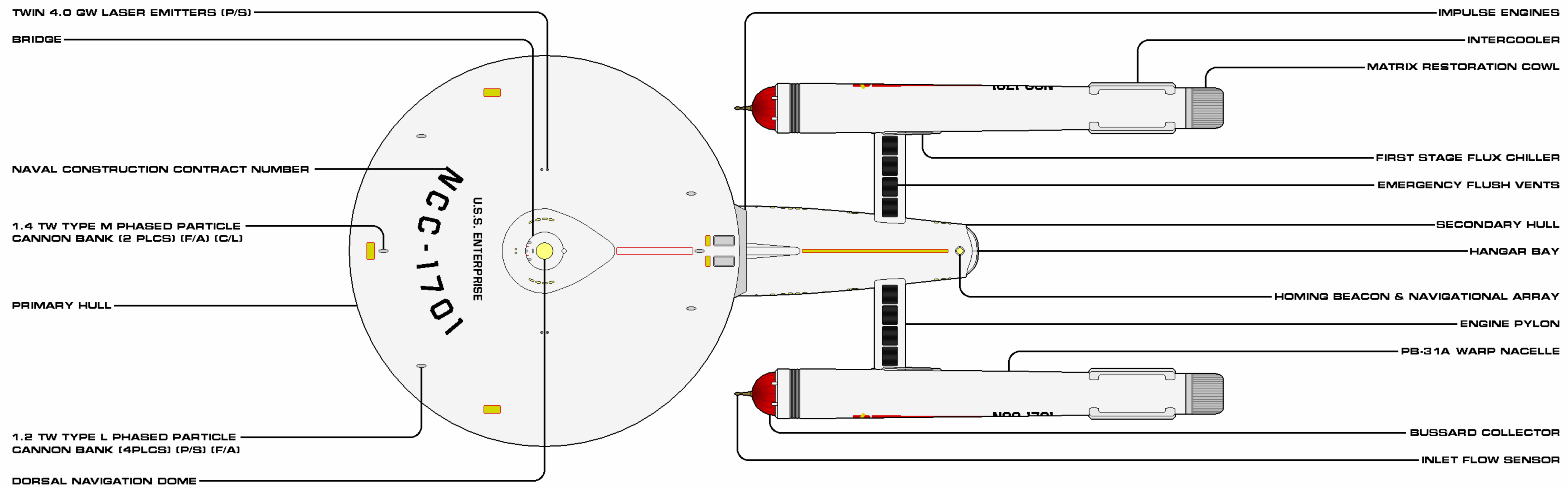
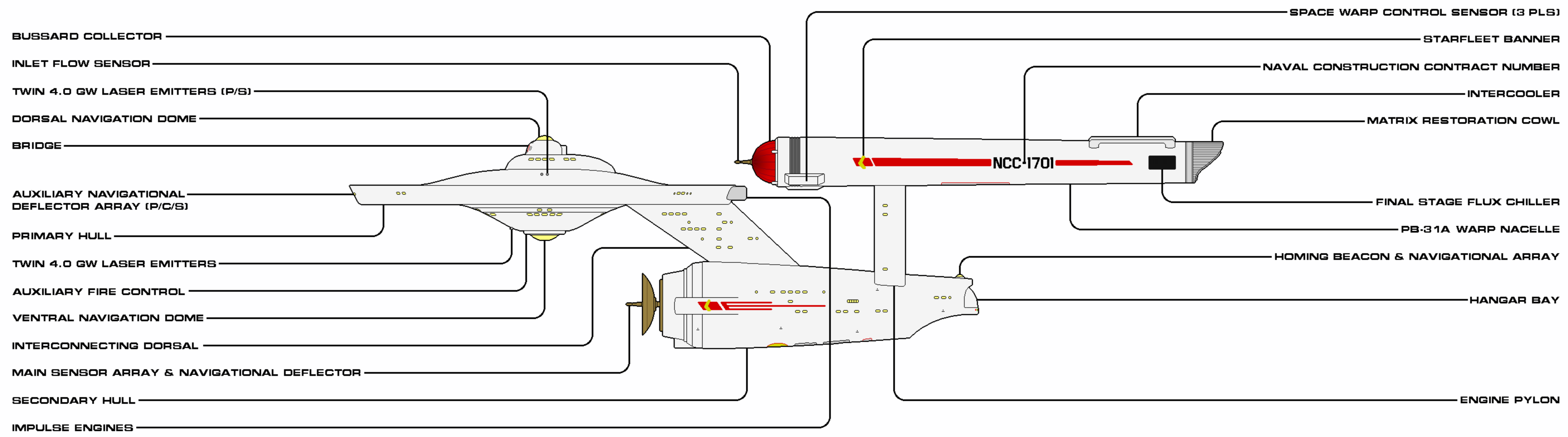

SHEET 1 OF 2

CLASS CONSTITUTION	CATEGORY HEAVY CRUISER
VARIANT PRODUCTION STD.	CONSTRUCTED 2245
LENGTH 208.6 M	BEAM 121.1 M
HEIGHT 12.6 M	MASS 679,300 MT
OPERATIONAL 11	RELEASE DATE 2002.05

Authorized for release by Star Fleet Bureau of Starship Construction

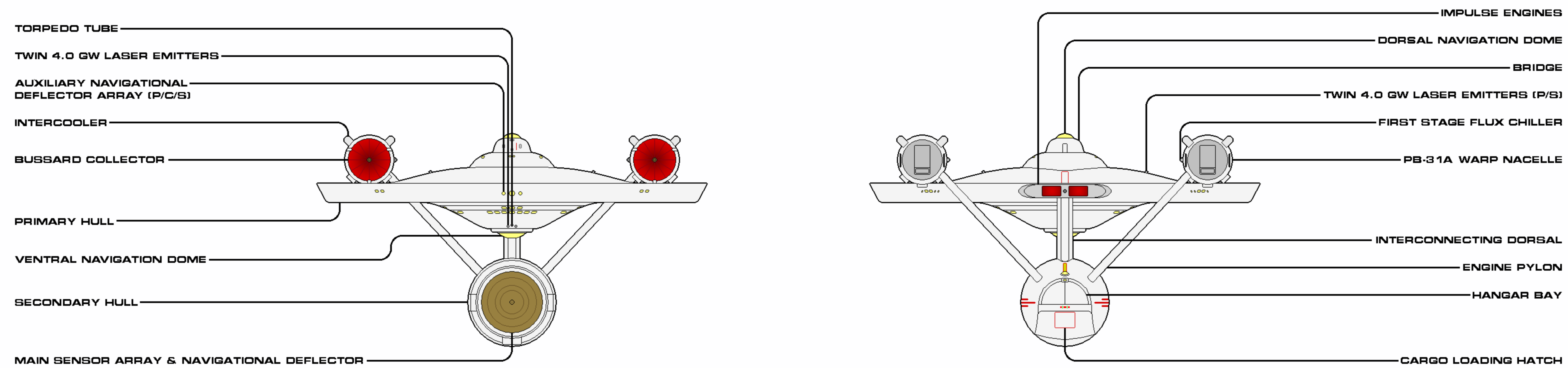
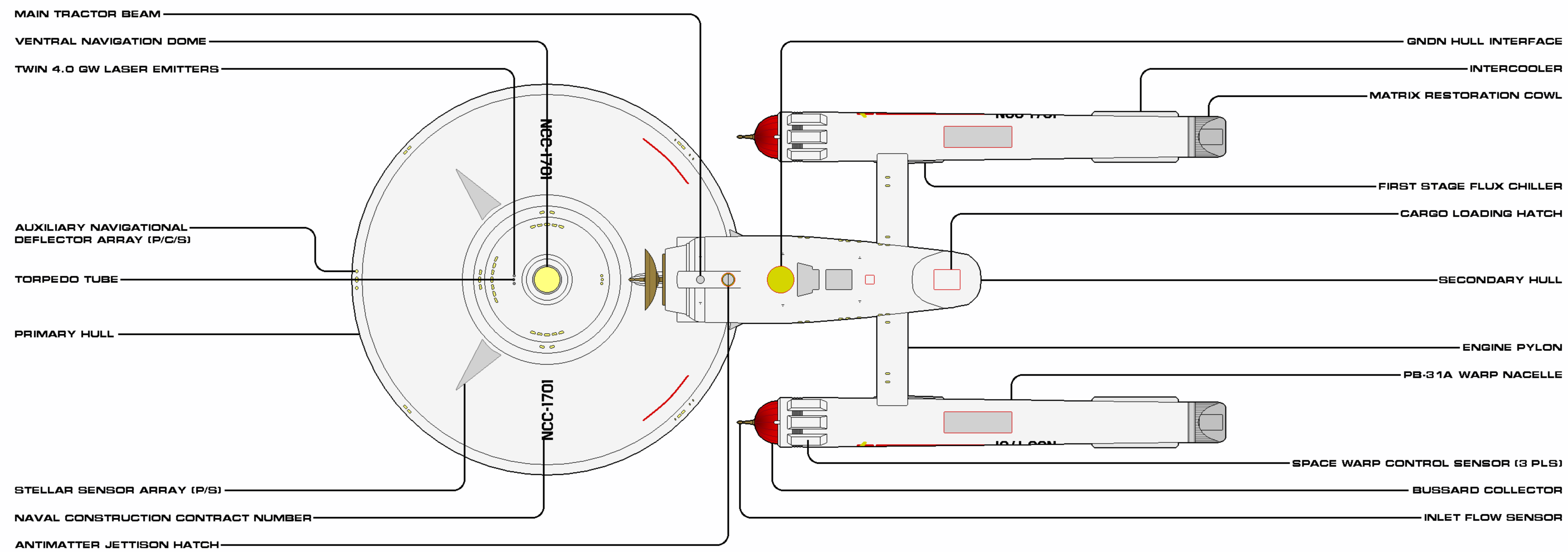

SHEET 2 OF 2

CLASS	CONSTITUTION	CATEGORY	HEAVY CRUISER
VARIANT	PRODUCTION STD.	CONSTRUCTED	2245
LENGTH	288.6 M	BEAM	121.1 M
HEIGHT	12.6 M	MASS	679,300 MT
OPERATIONAL	11	RELEASE DATE	2002.05

Authorized for release by Star Fleet Bureau of Starship Construction



USS CONSTITUTION (OPERATIONAL STANDARD)

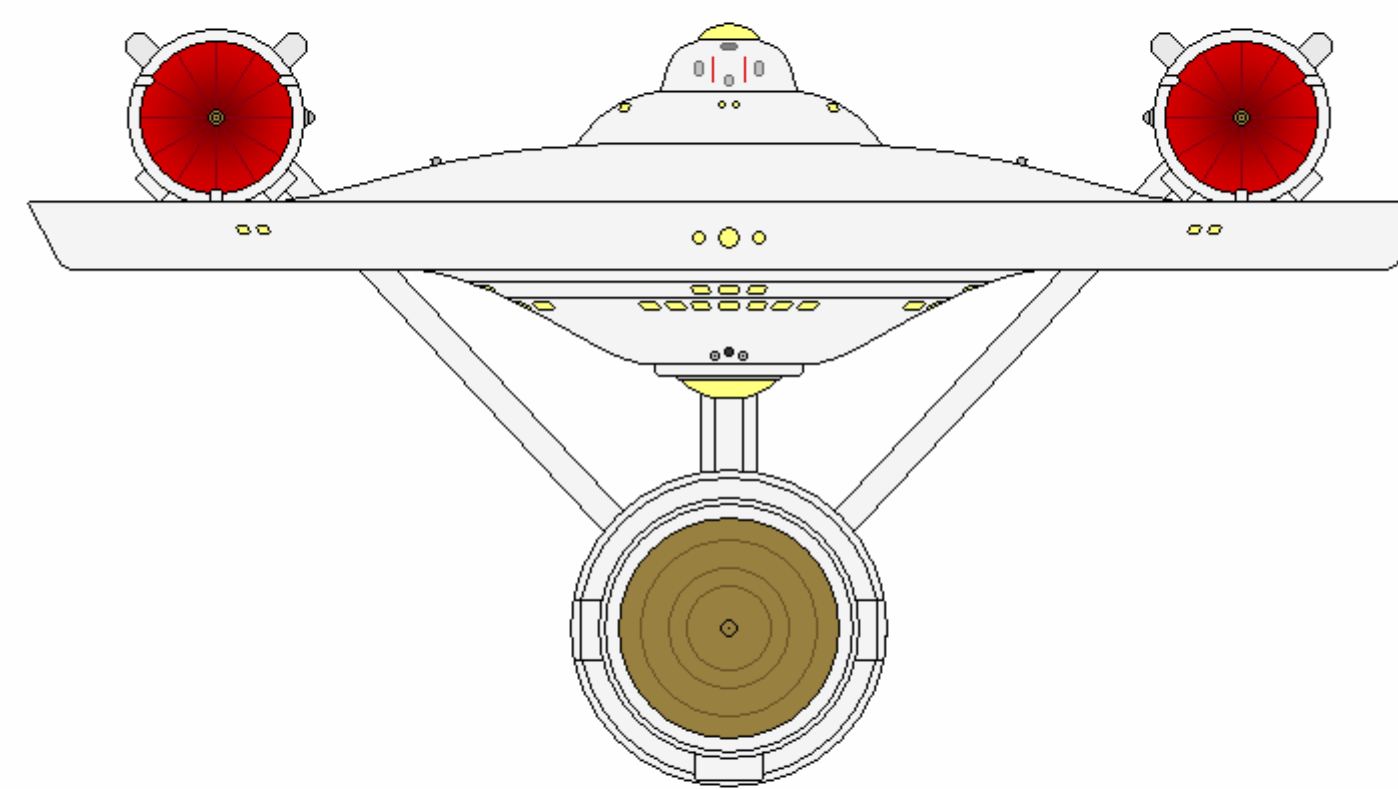
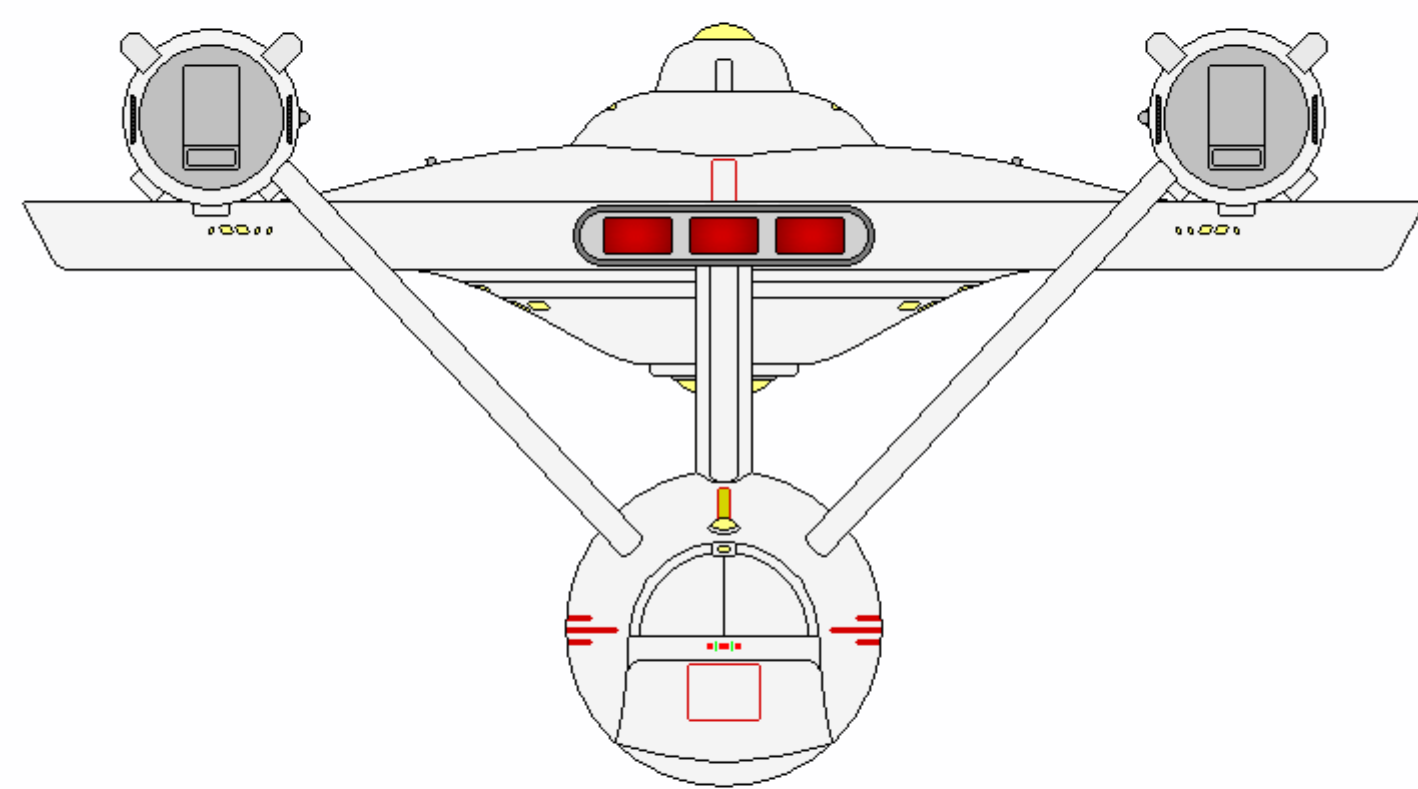
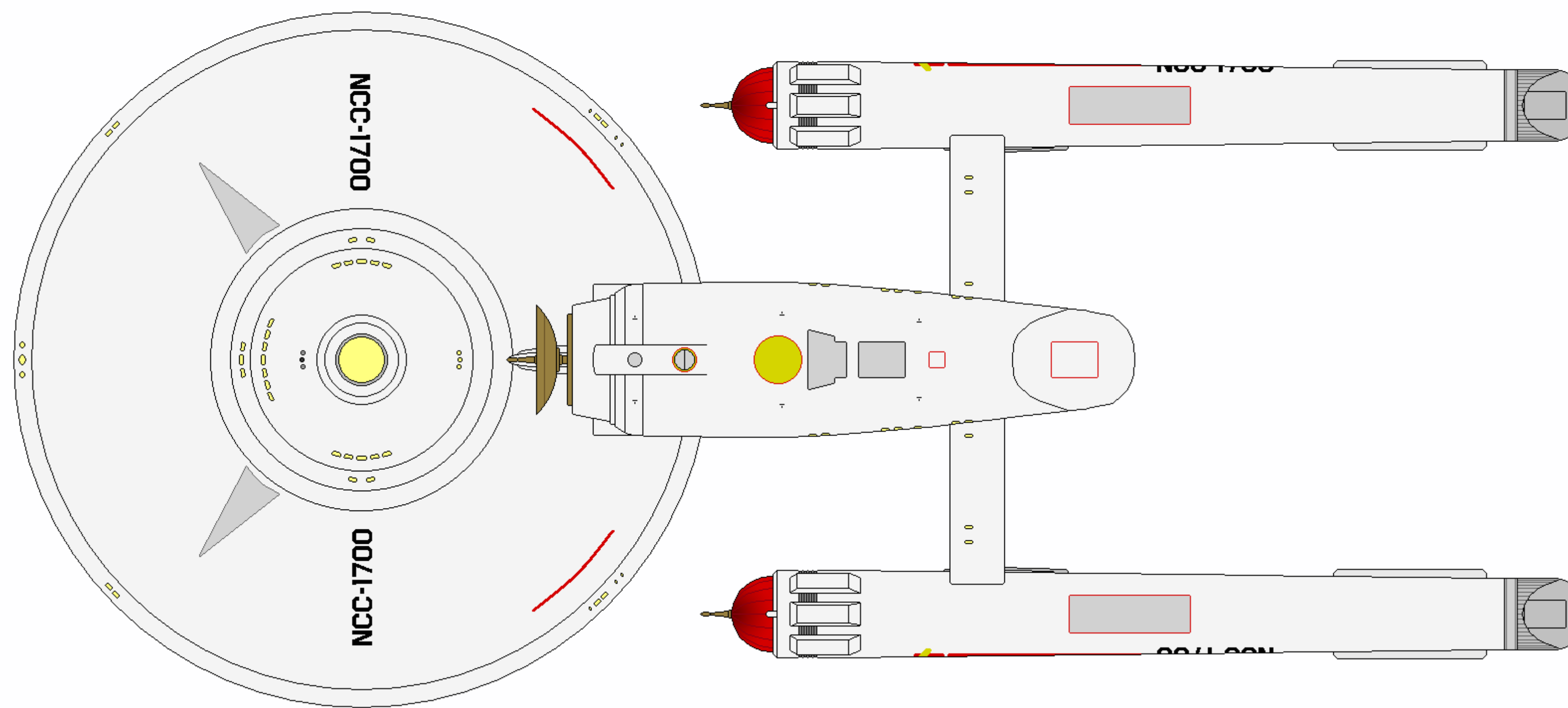
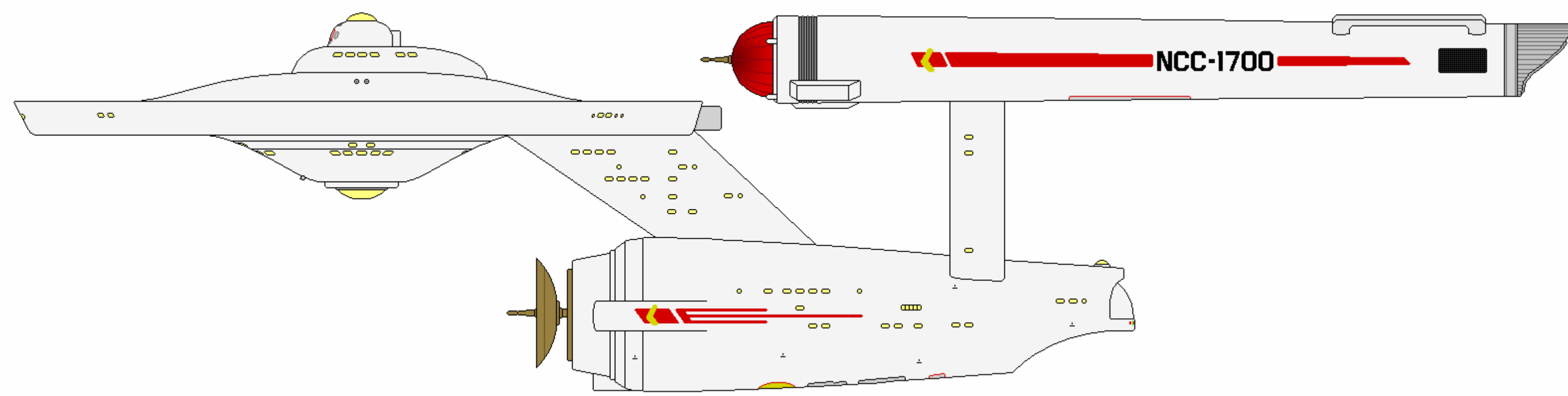
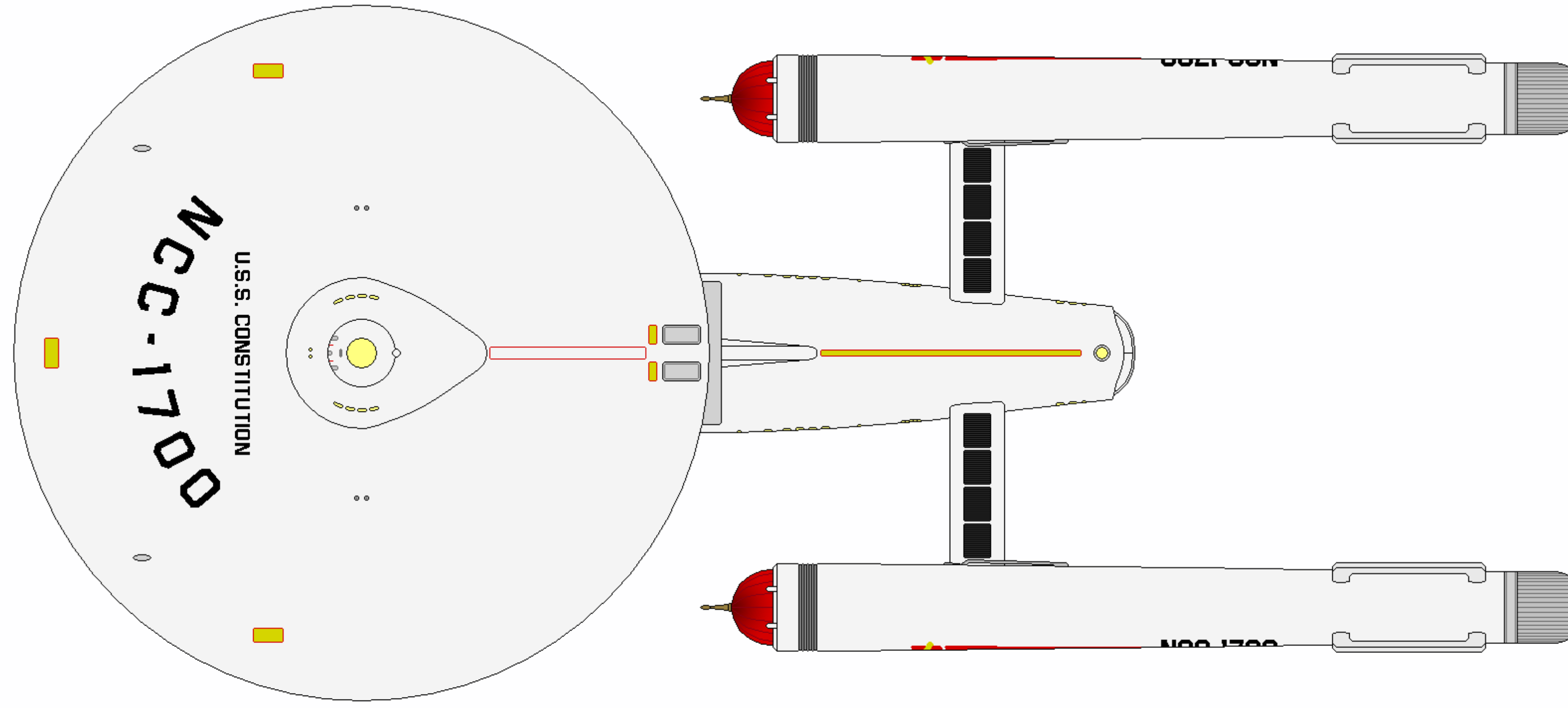



USS CONSTITUTION (OPERATIONAL STANDARD)

CATEGORY: HEAVY CRUISER
OPERATIONAL: 2245 - 2254
MODIFIED: 1 (PRODUCTION PROTOTYPE)

DIMENSIONS:		TACTICAL:
LENGTH:	288.6 M	- 6X 4.0 GW LASER EMITTERS
BEAM:	127.1 M	- 2X 1.2 TW TYPE L PHASED PARTICLE CANNONS
HEIGHT:	72.6 M	- 1X MEDIUM TORPEDO TUBE
MASS:	698,400 MT	(W/ 80 PHOTON TORPEDOES)

PERFORMANCE:		- 1-LAYER CONFORMAL FORCEFIELD
CRUISE:	WARP 6 (OCU)	- 1X PRIMARY NAVIGATIONAL DEFLECTOR
MAX:	WARP 8 (OCU)	- 3X AUXILIARY NAVIGATIONAL DEFLECTORS
ENDURANCE:	5 YEARS	

COMPLEMENT:		AUXILIARIES:
OFFICERS:	69	- 2X MEDIUM OR 4X LIGHT SHUTTLES
ENLISTED:	392	- 4X SHUTTLEPODS
		- 4X WORK PODS

AUTHORIZED CONSTRUCTION

THE FOLLOWING SHIPS OF THE ABOVE CLASS WERE AUTHORIZED AS PART OF THE FEDERATION STAR FLEET BY FEDERATION COUNCIL APPROPRIATION. THE VESSEL WITH REGISTRY 1700 WAS CONVERTED FROM THE PREVIOUS PROTOTYPE CONFIGURATION.

USS CONSTITUTION NCC-1700

GENERAL INFORMATION

Constitution had a rough start: three battles against the Klingons, two of which were significant in the history of the Four Years War, and all before she was commissioned. Following the battle of Donatu V in 2242, she returned to Earth, transferred her combat sensor tapes to Star Fleet Tactical, and received onboard a swarm of damage control teams. However, instead of being repaired to her pre-war configuration, she was sealed off, shut down, and towed into drydock.

Her experience at the Battles of (First) Axanar, Lea, and Donatu V were absolutely the catalyst for the transformation occurring within that shipyard and it dictated that for her sister ship, Enterprise. Externally, they were similar except for the impulse engines and armament. She retained her Siva impulse engines, even though they produced less thrust per nozzle; her saucer had not been replaced with the improved standard, but rebuilt. Her team had every intention of having her awarded the class ship designation and retaining the barely-employed propulsion equipment would be a time saver, if not a space saver. Similarly, during the reconstruction, it was decided she would keep her weapons loadout of six 4.0-gigawatt laser emitters and 2 Type L phased particle cannons, because they had already proven to not only work, but work very well in combat situations. The Enterprise would have more visible weaponry (with 2 additional Type L and 2 more powerful Type M cannons), but it was argued that as the Federation's future flagship, discretion would be the better part of valor.

Constitution and Enterprise would be commissioned and inscribed within Star Fleet's registry within days of each other, though it was the sister ship's very similar configuration that would be the standard for the remaining 10 vessels of the production run. Apparently, the decision to keep the larger impulse engines was one of the deciding factors: both ships required a crew of 461 and the inspection team immediately recognized the value of the larger personal space onboard Enterprise in comparison. However, to honor her valiant efforts during the recently concluded war and acknowledge that it is generally the lead newbuild ship that loans the name to the class, "Constitution" was chosen for the heavy cruisers' shared name. She would remain in this configuration until converted into a Flight II in the 2250s.

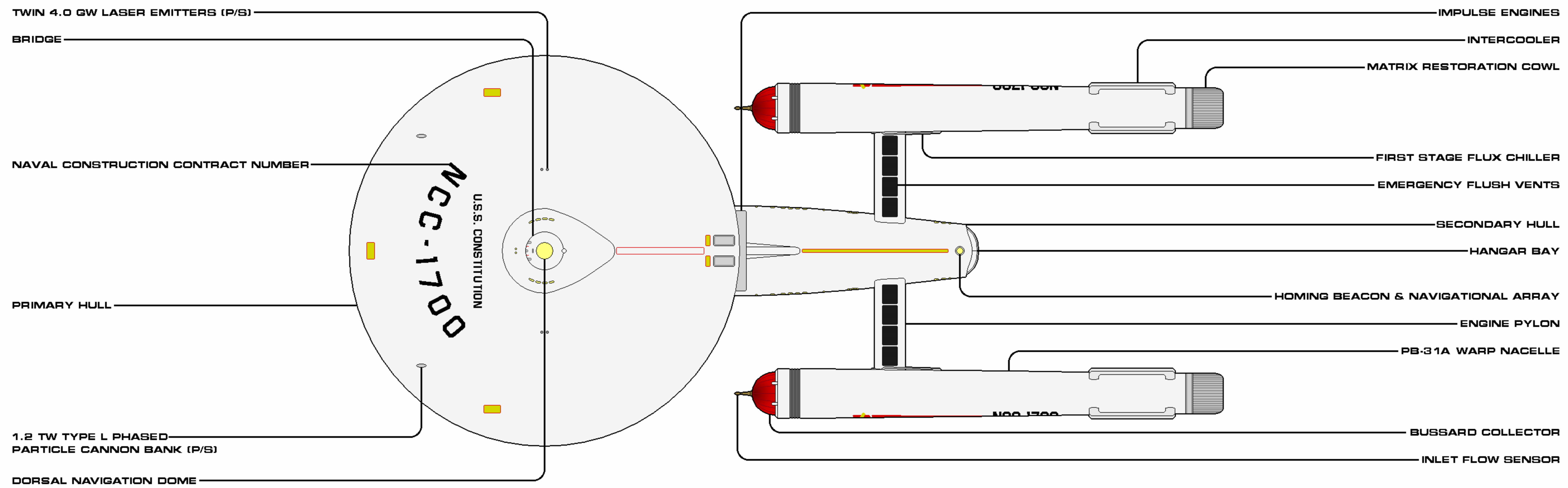
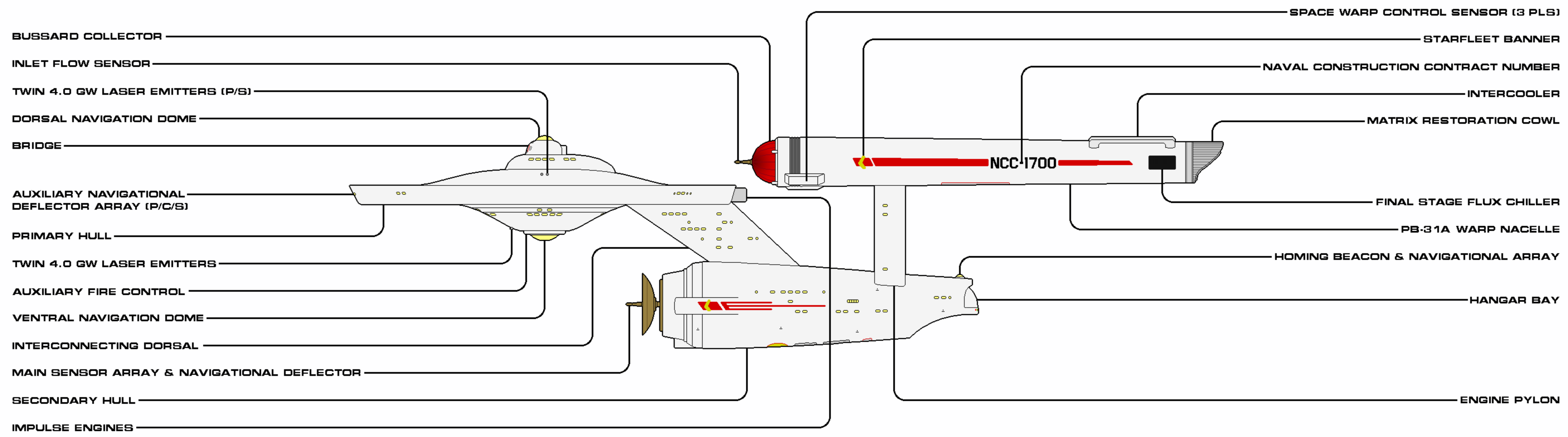

SHEET 1 OF 2

CLASS	CONSTITUTION	CATEGORY	HEAVY CRUISER
VARIANT	OPERATIONAL STD.	MODIFIED	2245
LENGTH	208.6 M	BEAM	121.1 M
HEIGHT	12.6 M	MASS	698,400 MT
OPERATIONAL	1	RELEASE DATE	2002.05

Authorized for release by Star Fleet Bureau of Starship Construction

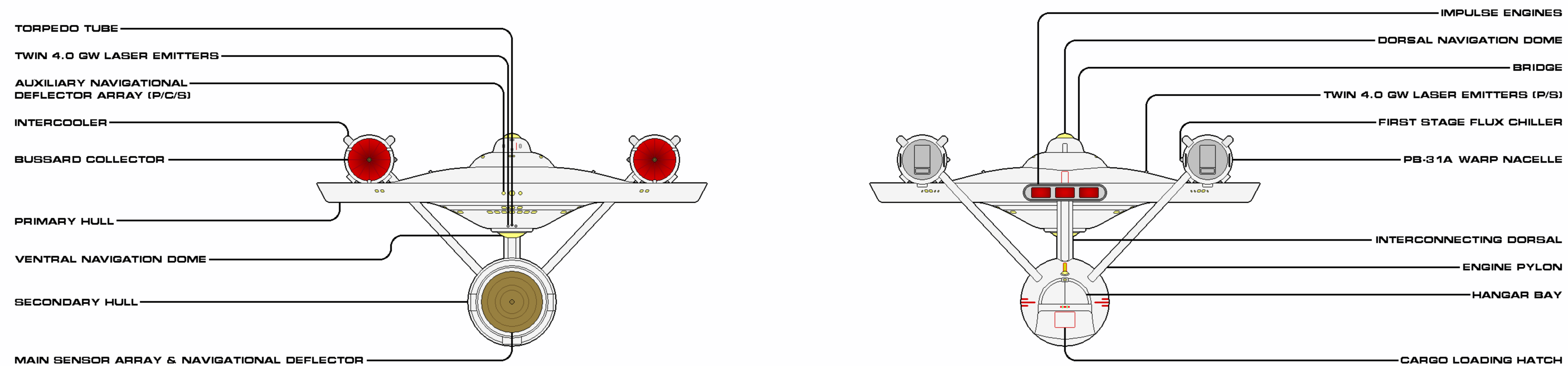
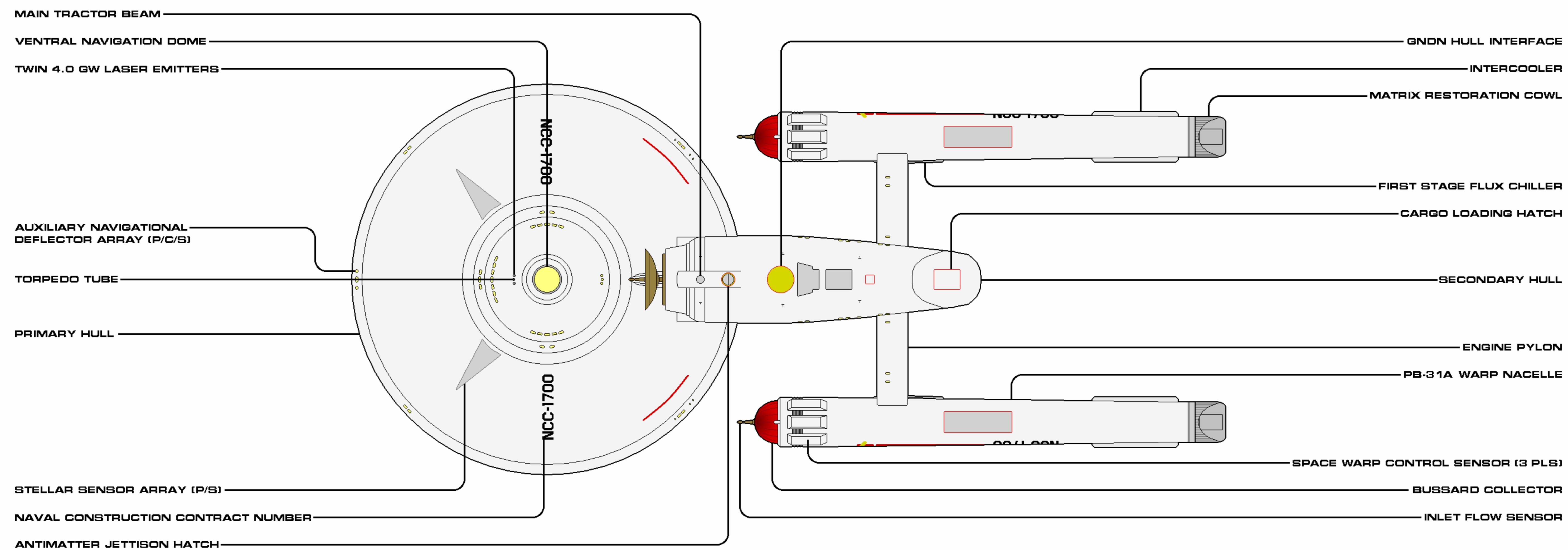

SHEET 2 OF 2

CLASS	CONSTITUTION	CATEGORY	HEAVY CRUISER
VARIANT	OPERATIONAL STD.	MODIFIED	2245
LENGTH	288.6 M	BEAM	121.1 M
HEIGHT	12.6 M	MASS	638,400 MT
OPERATIONAL	1	RELEASE DATE	2002.05

Authorized for release by Star Fleet Bureau of Starship Construction



USS CONSTELLATION (OPERATIONAL STANDARD)

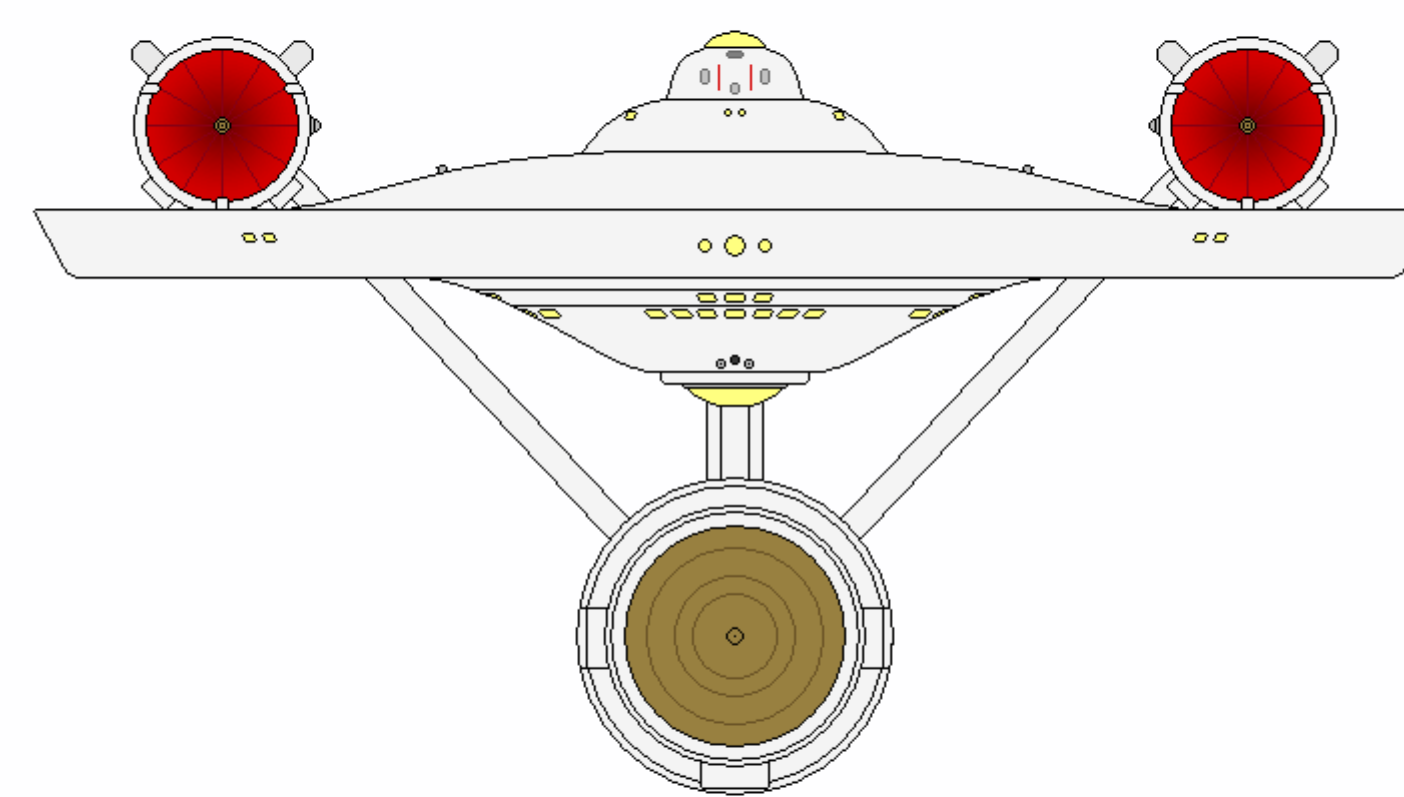
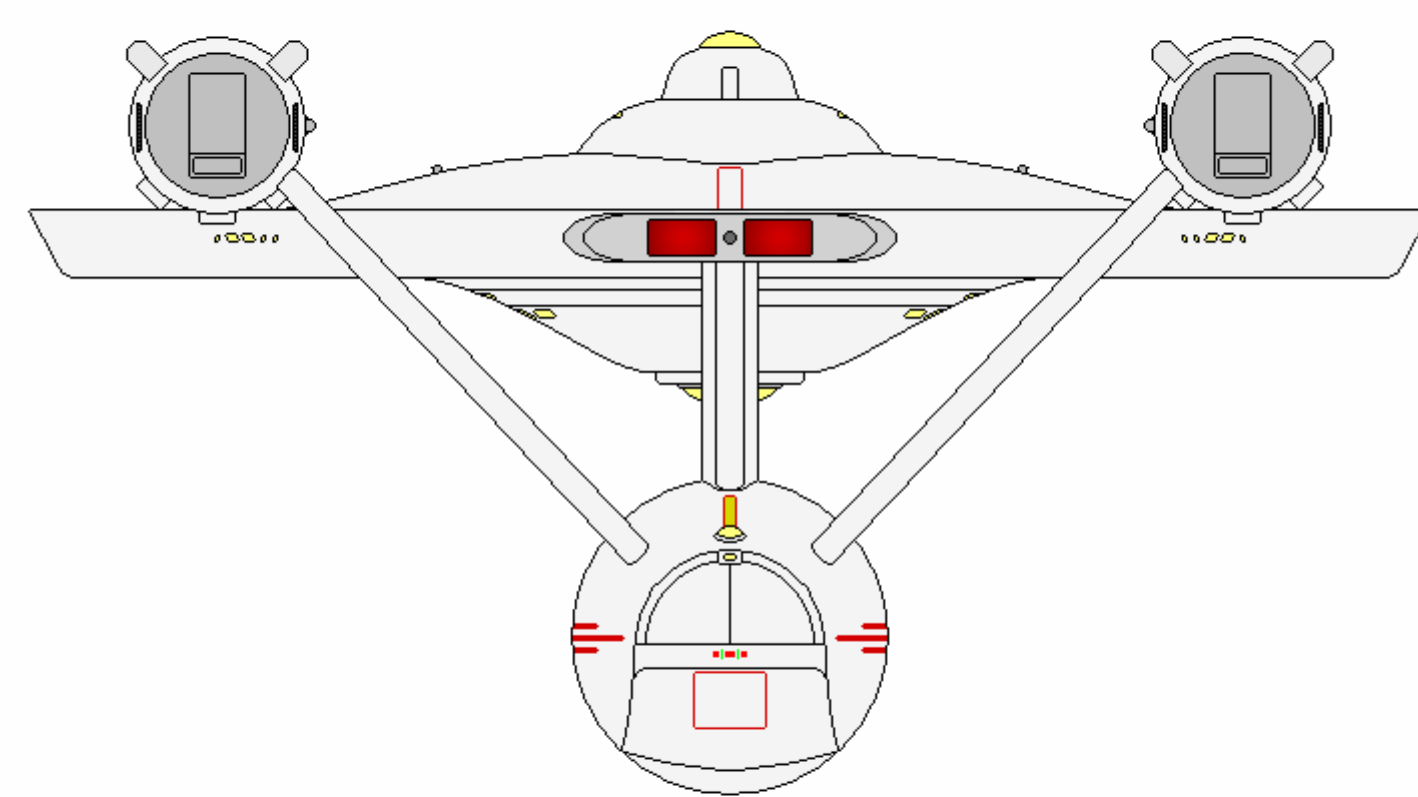
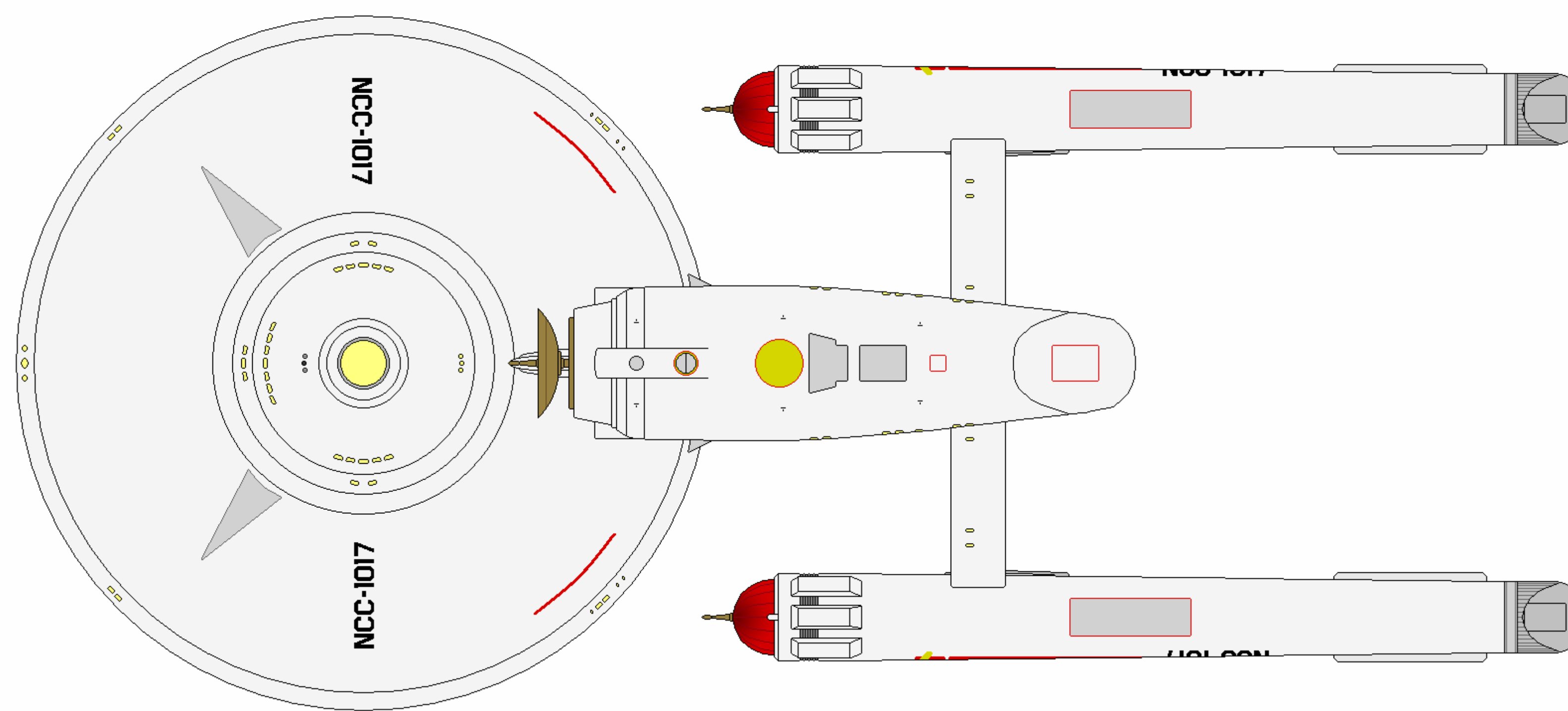
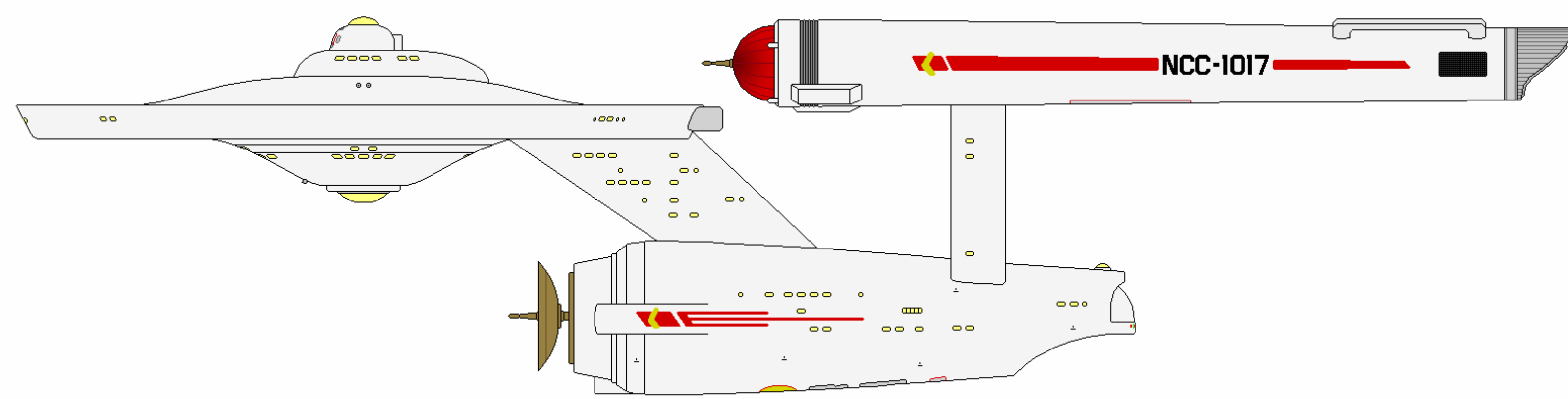
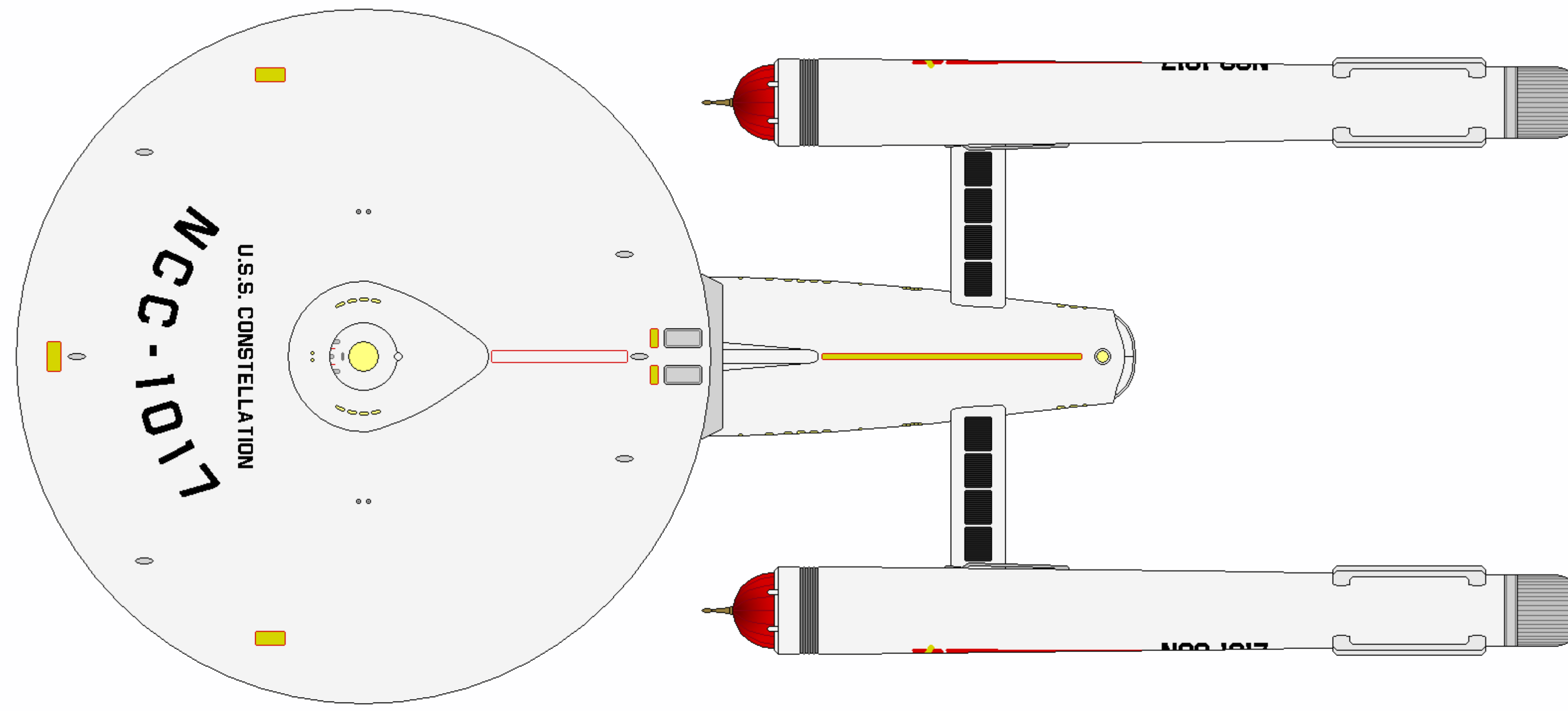



USS CONSTELLATION (OPERATIONAL STANDARD)

CATEGORY:	HEAVY CRUISER	
OPERATIONAL:	2245 - 2253	
MODIFIED:	1 (HEAVY CRUISER TESTBED)	
DIMENSIONS:		TACTICAL:
LENGTH:	288.6 M	- 6X 4.0 GW LASER EMITTERS
BEAM:	127.1 M	- 4X 1.2 TW TYPE L PHASED PARTICLE CANNONS
HEIGHT:	72.6 M	- 2X 1.4 TW TYPE M PHASED PARTICLE CANNONS
MASS:	696,200 MT	- 1X MEDIUM TORPEDO TUBE (W/ 80 PHOTON TORPEDOES)
PERFORMANCE:		- 1-LAYER CONFORMAL FORCEFIELD
CRUISE:	WARP 6 (OCU)	- 1X PRIMARY NAVIGATIONAL DEFLECTOR
MAX:	WARP 8 (OCU)	- 3X AUXILIARY NAVIGATIONAL DEFLECTORS
ENDURANCE:	5 YEARS	
COMPLEMENT:		AUXILIARIES:
OFFICERS:	69	- 1X HEAVY SHUTTLE
ENLISTED:	392	- 2-4X LIGHT SHUTTLES
		- 4X SHUTTLEPODS
		- 4X WORK PODS
		- VARIOUS SPECIAL ENVIRONMENT/TACTICAL CRAFT

AUTHORIZED CONSTRUCTION

THE FOLLOWING SHIPS OF THE ABOVE CLASS WERE AUTHORIZED AS PART OF THE FEDERATION STAR FLEET BY FEDERATION COUNCIL APPROPRIATION. THE VESSEL WITH REGISTRY 1017 WAS CONVERTED FROM THE PREVIOUS TESTBED CONFIGURATION.

USS CONSTELLATION NCC-1017

GENERAL INFORMATION

Constellation was the original "lead" vessel of Project Starship, having served around 17 years as an Advance class battle cruiser, before being removed from active service in 2219 due to severe battle damage. Granted to the Chiokis shipbuilders in 2222, over the next 23 years she was dismantled, reconstructed, tested and warp-ran, and then reconstructed again. That last prototypical rebuild bore light on the silhouette of what would become the epitome of a Star Fleet starship for decades.

At the time of sister test ship Republic's own conversion into the prototype third-generation heavy cruiser, it was thought that Constellation's time in reconstruction did not provide a solid basis for determining what lengths and costs would be associated with converting a typical Horizon to the new standards. Instead, because of great faith in her physical superstructure, it was decided she would "join" the future class as a one-off variant, possibly serving alongside the production vessels or (more likely) as a training ship for those crews that would be trusted to take those same vessels out to the frontiers of Federation space. In mid-2239, she entered the shipyard once again in order to be equipped with the sensors, living spaces, weaponry and propulsion necessary to truly make her operational.

However, mere months before her early-2243 scheduled re-commissioning, work efforts were ordered halted. Early analysis of the Constitution combat sensor tapes suggested the Republic design could undoubtedly be improved upon and it would be intuitive to include such improvements on Constellation. By the time the re-finalized production plans were completed, the external shapes—specifically of the secondary hull—were far more similar to the originating Horizon class, which Constellation had retained—until 2239. The reconversion of Constellation, Republic, and Constitution began in 2244, alongside the continuing construction of Enterprise (NCC-1701). Of note, in order to commit due diligence, a last study was made to again catalog every difference between the finalized Constellation and Republic designs in order to properly ascertain how difficult and costly it might be to convert the remaining Horizons to the Starship standard. With little surprise to anyone, it would be unfeasible to conduct such a conversion on what was noted to be a class of ship designed and first fielded almost sixty years prior.

USS Constellation was re-commissioned in June 2245 and served in her initial Constitution production standard variant—in a primary exploration and diplomacy role—until Flight II configuration in the 2250s. In the mid-Sixties she would be overhauled into the Bonhomme Richard standard, just prior to her 2267 loss—and that of the highly decorated Commodore Matt Decker—to a leviathan of possible extragalactic origin.

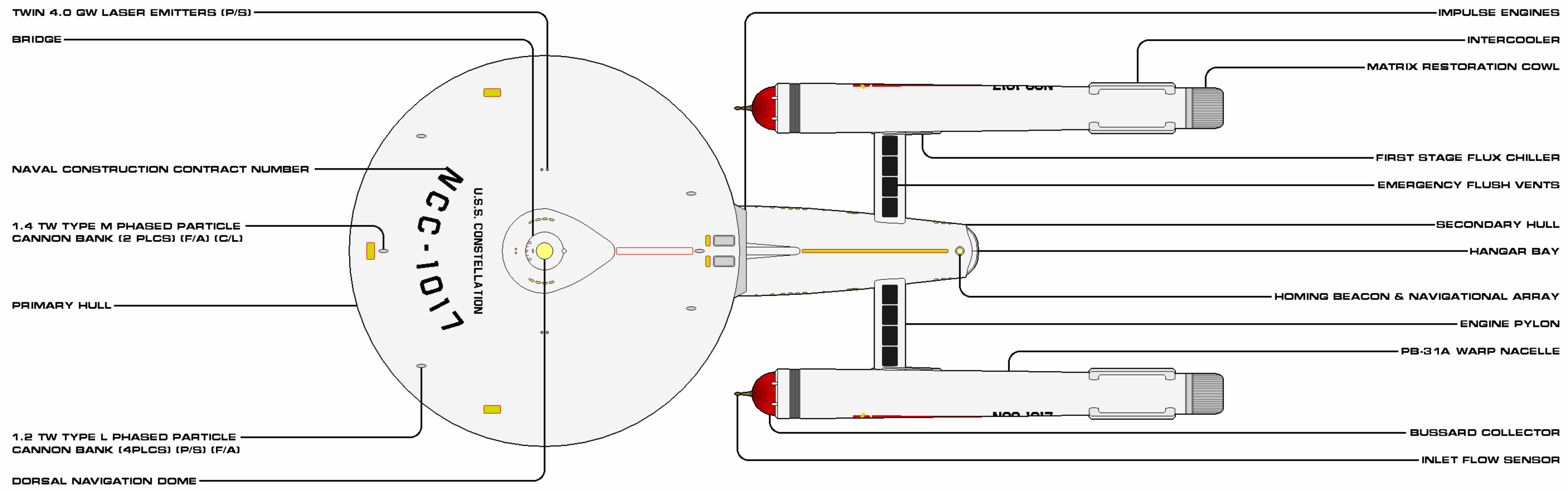
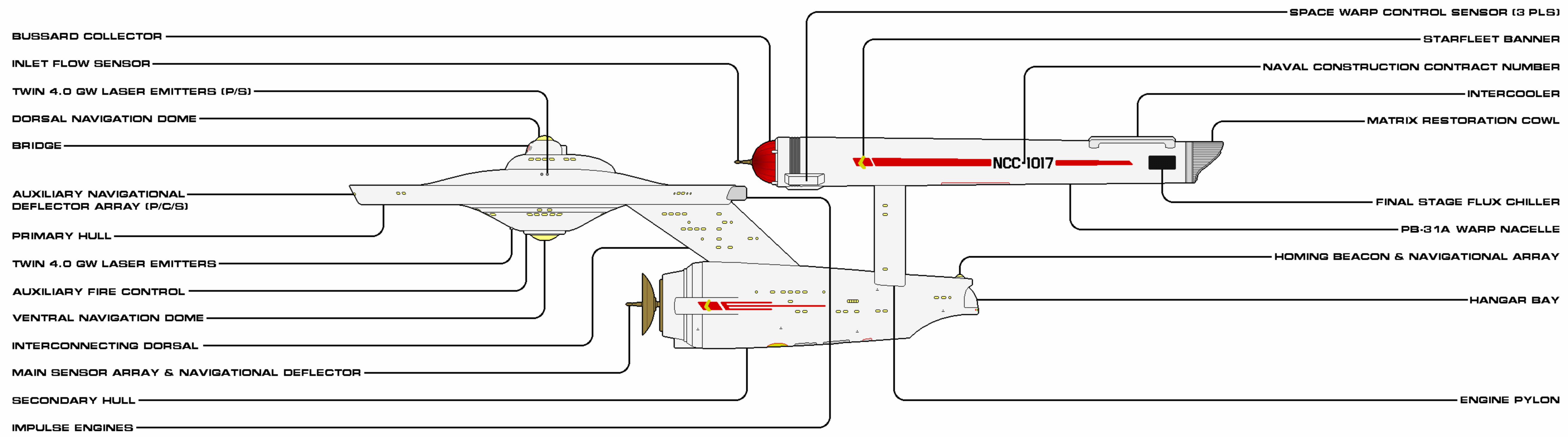

SHEET 1 OF 2

CLASS	CONSTITUTION	CATEGORY	HEAVY CRUISER
VARIANT	OPERATIONAL STD.	MODIFIED	2245
LENGTH	208.6 M	BEAM	121.1 M
HEIGHT	12.6 M	MASS	696,200 MT
OPERATIONAL	1	RELEASE DATE	2002.05

Authorized for release by Star Fleet Bureau of Starship Construction

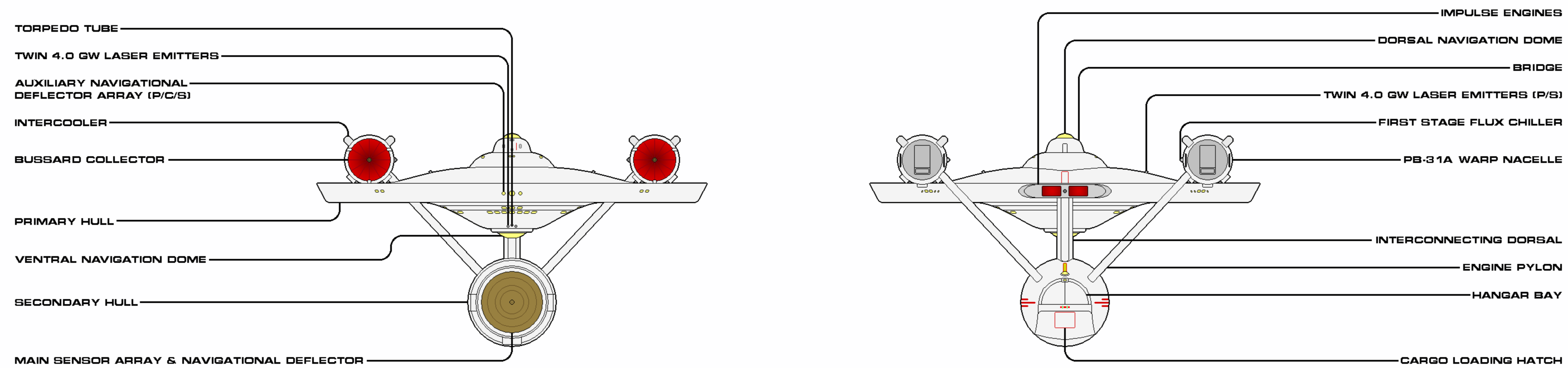
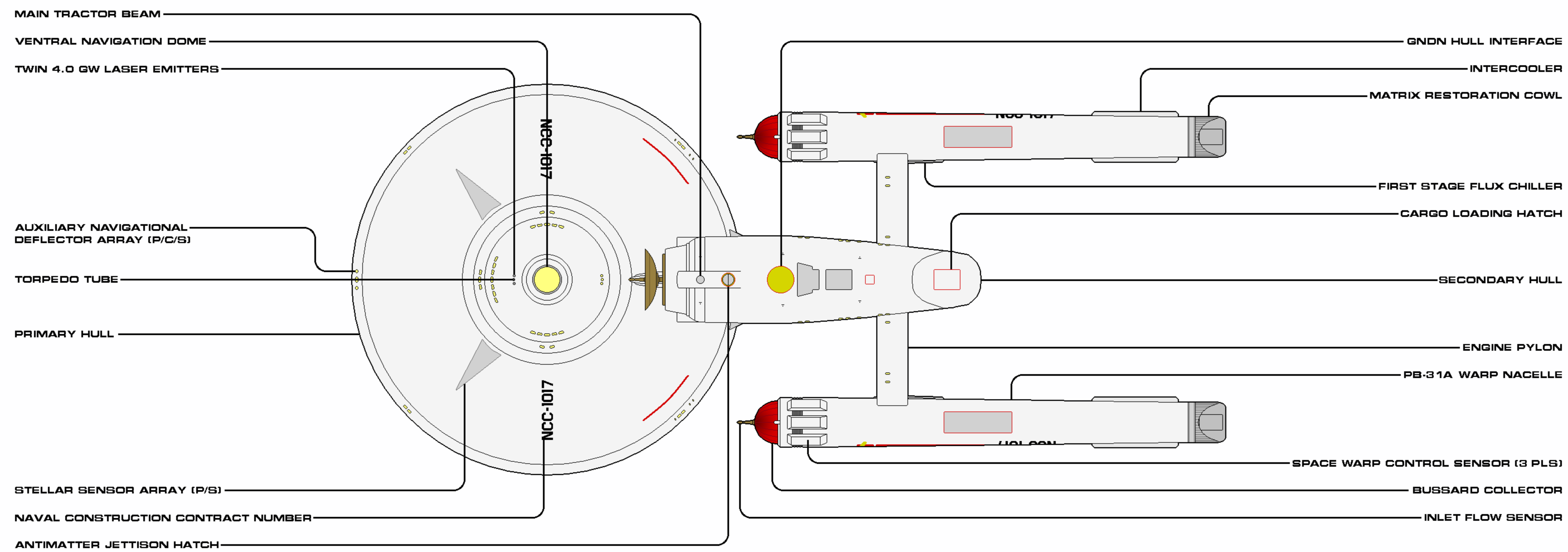

SHEET 2 OF 2

CLASS	CONSTITUTION	CATEGORY	HEAVY CRUISER
VARIANT	OPERATIONAL STD.	MODIFIED	2245
LENGTH	288.6 M	BEAM	121.1 M
HEIGHT	12.6 M	MASS	636,200 MT
OPERATIONAL	1	RELEASE DATE	2002.05

Authorized for release by Star Fleet Bureau of Starship Construction



USS REPUBLIC (OPERATIONAL STANDARD)

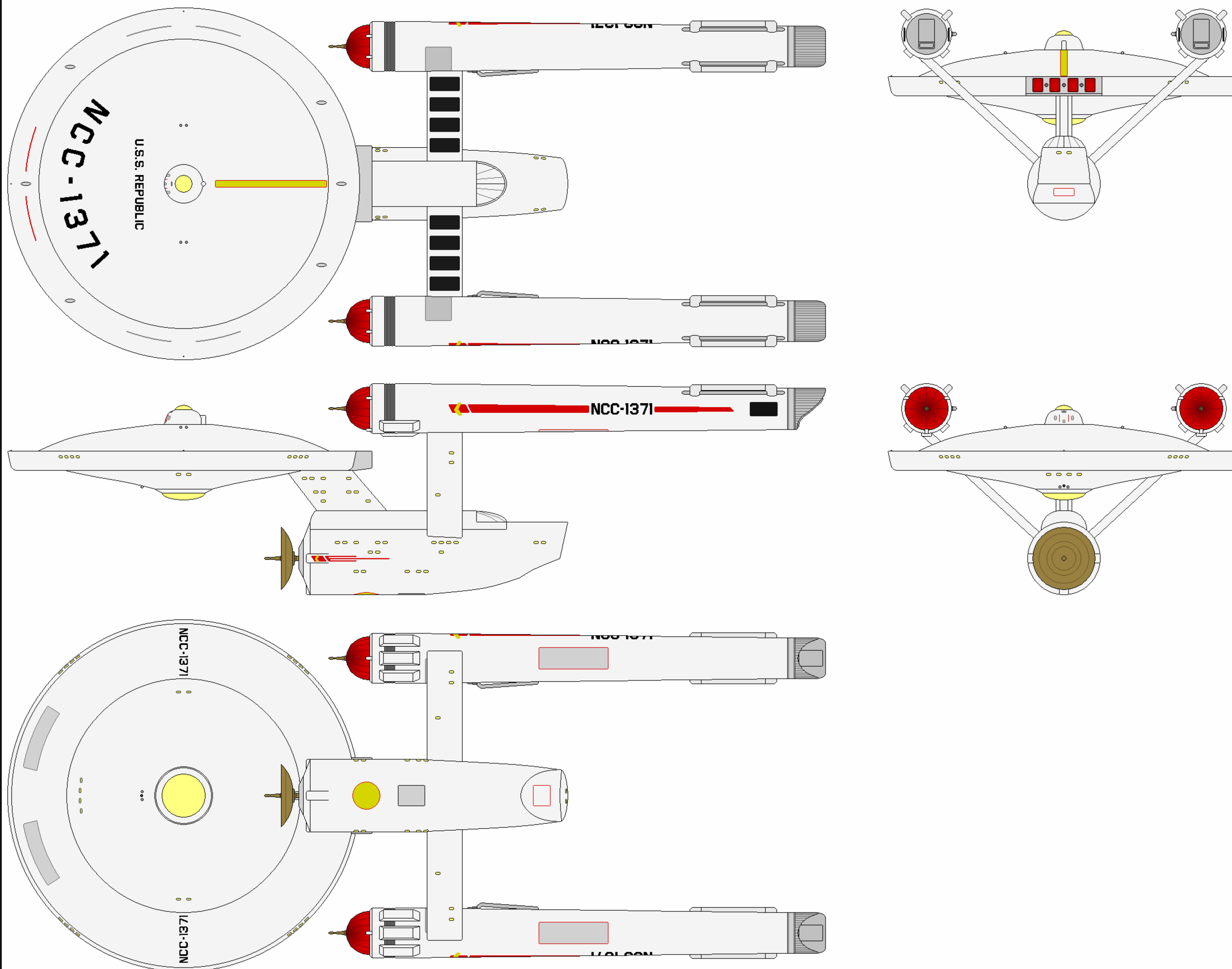

CATEGORY: HEAVY CRUISER
 OPERATIONAL: 2245 - 2257
 MODIFIED: 1 (HEAVY CRUISER PROTOTYPE)

DIMENSIONS:
 LENGTH: 265.2 M
 BEAM: 114.1 M
 HEIGHT: 68.3 M
 MASS: 699,900 MT

TACTICAL:
 - 6X 4.0 GW LASER EMITTERS
 - 2X 1.2 TW TYPE L PHASED PARTICLE CANNONS
 - 1X MEDIUM TORPEDO TUBE
 (W/ 80 PHOTON TORPEDOES)
 - 1-LAYER CONFORMAL FORCEFIELD
 - 1X PRIMARY NAVIGATIONAL DEFLECTOR

PERFORMANCE:
 CRUISE: WARP 6 (OCU)
 MAX: WARP 8 (OCU)
 ENDURANCE: 5 YEARS

COMPLEMENT:
 OFFICERS: 47
 ENLISTED: 263

AUXILIARIES:
 - 2X LIGHT SHUTTLES
 - 2X SHUTTLEPODS
 - 1X WORK POD



USS REPUBLIC (OPERATIONAL STANDARD) AUTHORIZED CONSTRUCTION

THE FOLLOWING SHIPS OF THE ABOVE CLASS WERE AUTHORIZED AS PART OF THE FEDERATION STAR FLEET BY FEDERATION COUNCIL APPROPRIATION. THE VESSEL WITH REGISTRY 1371 WAS CONVERTED FROM THE PREVIOUS PROTOTYPE CONFIGURATION.

USS REPUBLIC NCC-1371

GENERAL INFORMATION

With the finalization and subsequent selection of the Enterprise production standard, Star Fleet had the opportunity for one more "free" vessel (from the two testbed hulls), above the twelve authorized for Project Starship. The logical choice was the Republic (NX-1371), having been only months into her commission as an Archon subclass heavy cruiser when she suffered fire damage to her saucer, and then idled for years until tested as a project prototype. However, the Constellation (NX-1071) design and conversion teams made a convincing argument with their high confidence in the sustainability and structural strength of their ship, based on the tens of thousands of metric tons in hull and support improvements made through numerous test conversions.

Project manager Robert April directed the Republic conversion team to stand down until the Constellation was proven to be up to the challenge, and tasked the Republic's design team with developing two courses of action: one in which the ship was selected to be converted to production standard, following the lessons from the same conversion made for Constitution (NX-1700), and the other to provide a "simplified" example of the Starship class, that had most of the same characteristics—such as maneuvering, weaponry, and sensors. With the foreseen success of the Constellation teams' conversion in early 2244, the latter option for the Republic was directed.

Upon her re-commissioning in May 2245, USS Republic (NCC-1371) served in a defensive role, until formally assigned to training status in 2248. With the completion of USS Farragut (NCC-1702), the remaining production ships of the now-officially named Constitution class were arriving and Star Fleet's best crews of command, engineering, science, medical, and operations personnel were being assembled to take them out. Republic performed three- and four-month familiarization cruises for overlapping commissioning crews, demonstrating the advanced functions of the bridge, the superiority in maneuvering and speed, and—very importantly—the operational and maintenance procedures for the newest in dilithium-regulated antimatter annihilation drives.

USS Republic would maintain this configuration until her (relatively early) deactivation in 2257. As she was not seen as a viable candidate for either Constitution Flight II or Bonhomme Richard configurations (over the authorized construction of a newbuild), and her internal spaces limited her operational capacity, it was decided to mothball her for the time being.

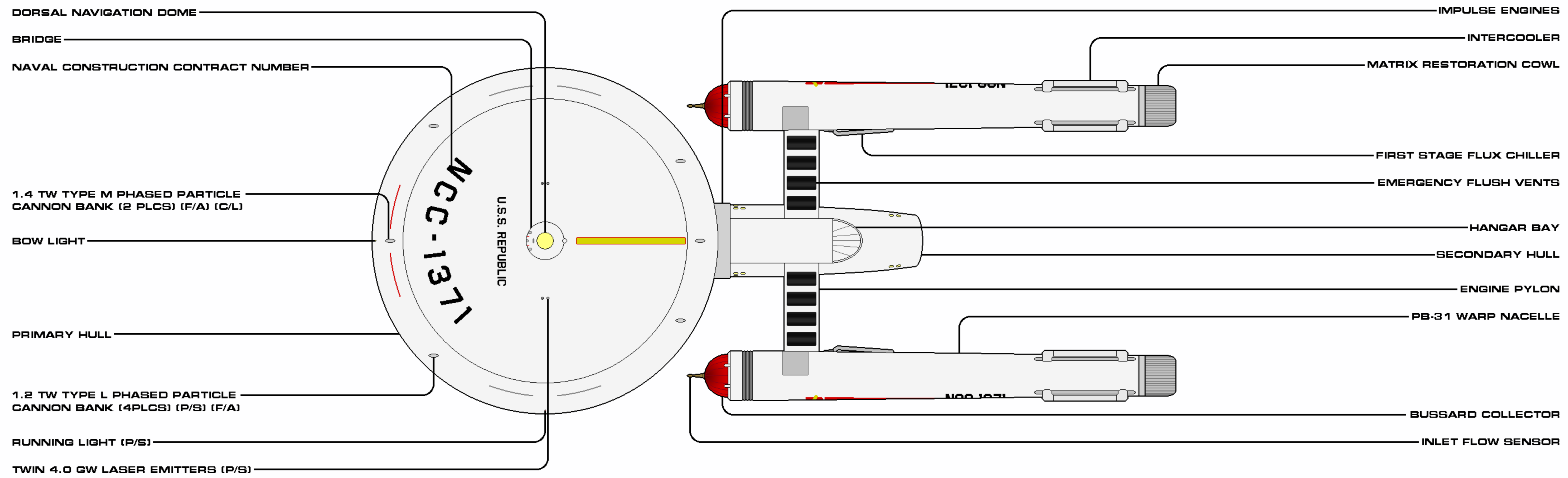
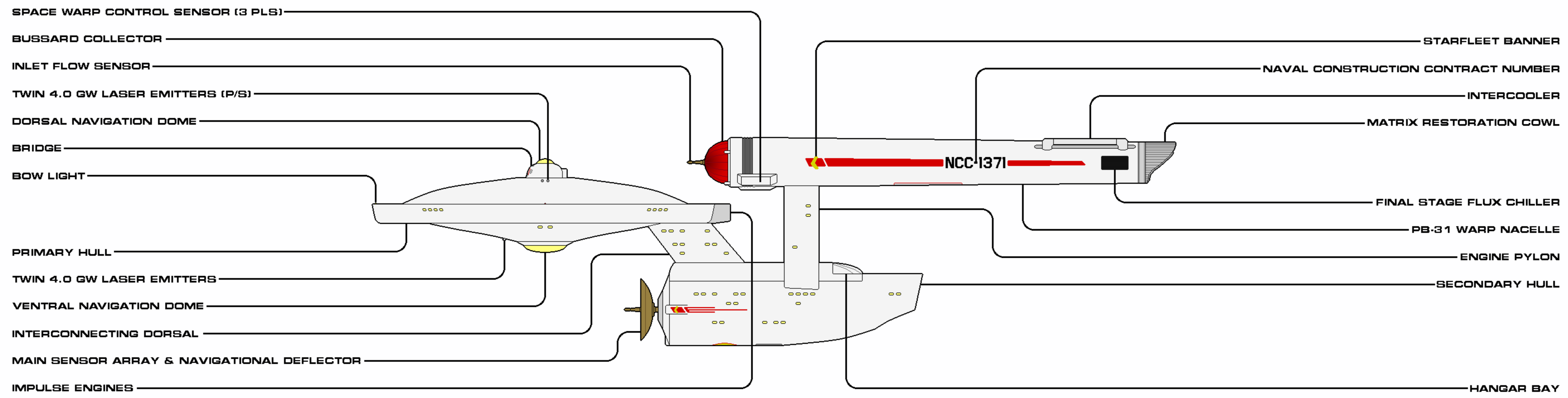

SHEET 1 OF 2

CLASS REPUBLIC	CATEGORY HEAVY CRUISER
VARIANT OPERATIONAL STD.	MODIFIED 2245
LENGTH 285.2 M	BEAM 114.1 M
HEIGHT 68.3 M	MASS 699,900 MT
OPERATIONAL 1	RELEASE DATE 2001.30

Authorized for release by Star Fleet Bureau of Starship Construction

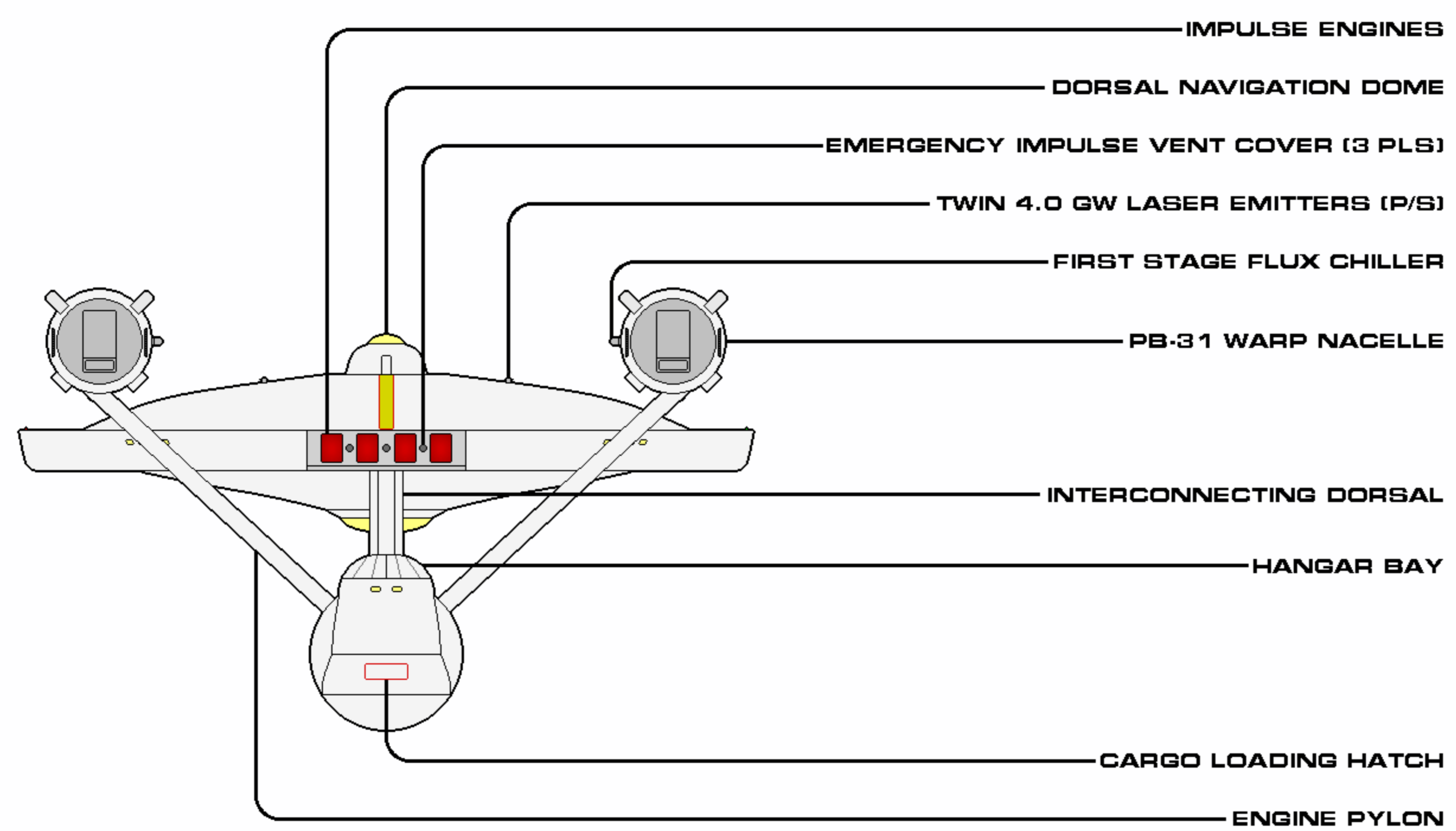
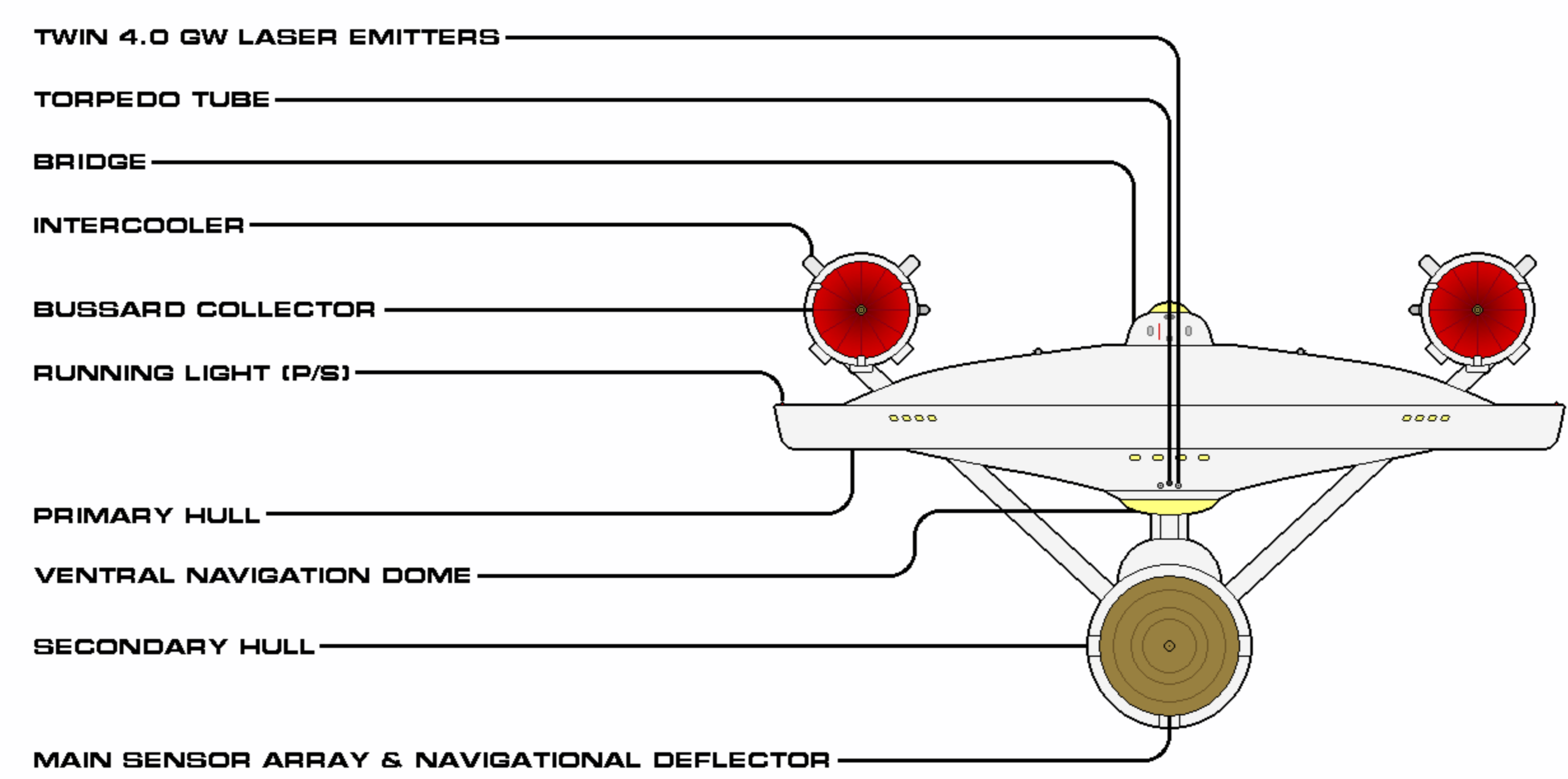
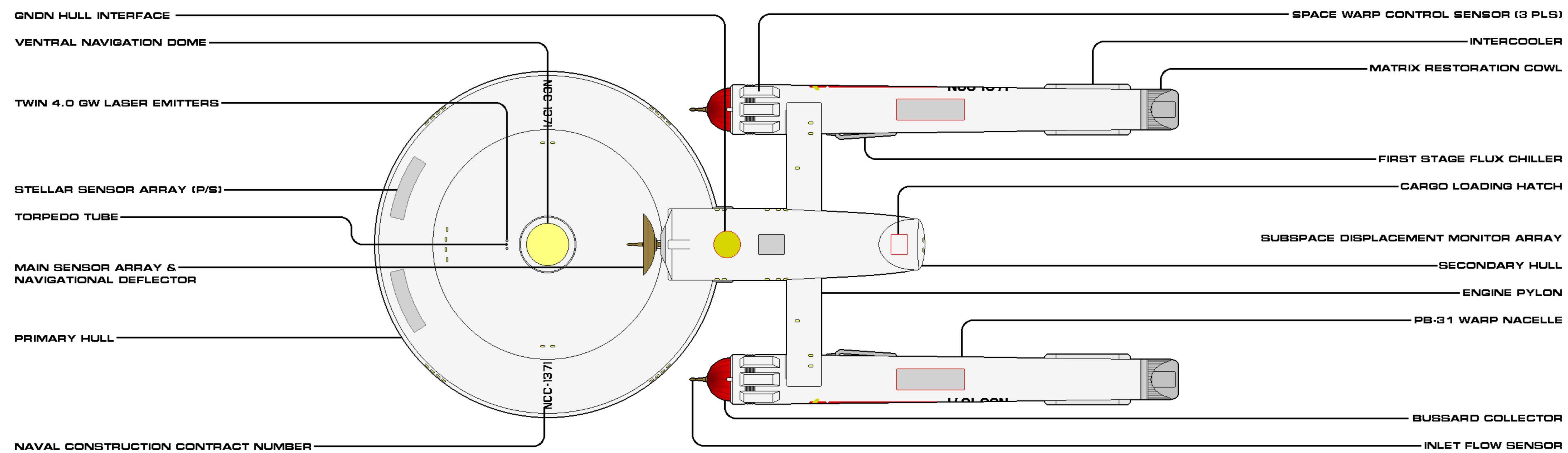

SHEET 2 OF 2

CLASS	REPUBLIC	CATEGORY	HEAVY CRUISER
VARIANT	OPERATIONAL STD.	MODIFIED	2245
LENGTH	265.2 M	BEAM	114.1 M
HEIGHT	68.3 M	MASS	699,900 MT
OPERATIONAL	1	RELEASE DATE	2001.30

Authorized for release by Star Fleet Bureau of Starship Construction

CONSTITUTION FLIGHT II

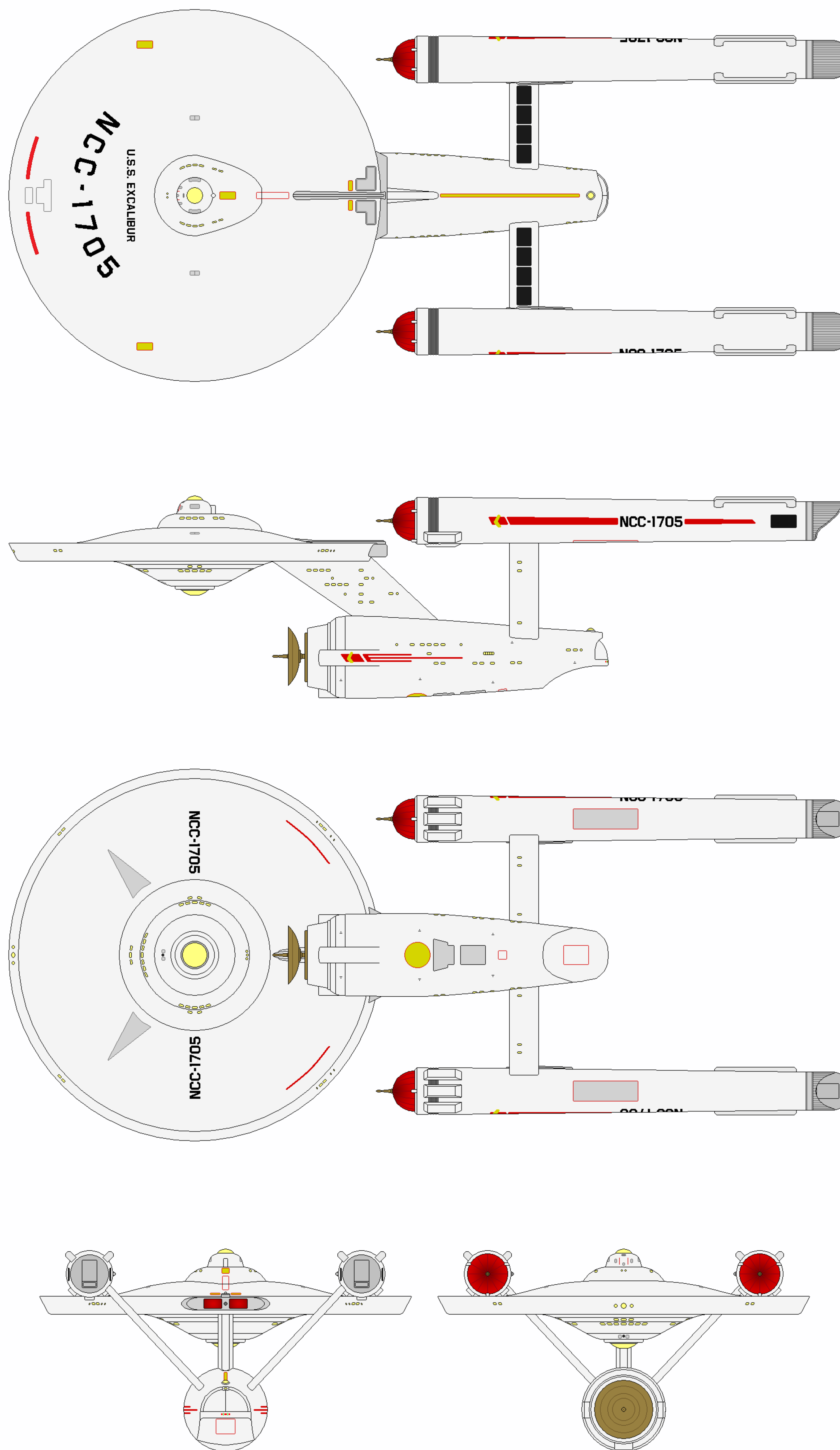



CONSTITUTION FLIGHT II

CATEGORY: HEAVY CRUISER
OPERATIONAL: 2251 - 2259
MODIFIED: 11 (CONSTITUTION CLASS)

DIMENSIONS:
LENGTH: 288.6 M
BEAM: 127.1 M
HEIGHT: 72.6 M
MASS: 680,700 MT

TACTICAL:
- 6X TYPE VII PHASER EMITTERS
- 1X MEDIUM TORPEDO TUBE
(W/ 80 PHOTON TORPEDOES)
- 1-LAYER CONFORMAL FORCEFIELD
- 1X PRIMARY NAVIGATIONAL DEFLECTOR
- 3X AUXILIARY NAVIGATIONAL DEFLECTORS

PERFORMANCE:
CRUISE: WARP 6 (OCU)
MAX: WARP 8 (OCU)
ENDURANCE: 5 YEARS

COMPLEMENT:
OFFICERS: 50
ENLISTED: 293

AUXILIARIES:
- 1X HEAVY SHUTTLE
- 2-4X LIGHT SHUTTLES
- 4X SHUTTLEPODS
- 4X WORK PODS
- VARIOUS SPECIAL ENVIRONMENT/TACTICAL CRAFT

AUTHORIZED CONSTRUCTION

THE FOLLOWING SHIPS OF THE ABOVE CLASS WERE AUTHORIZED AS PART OF THE FEDERATION STAR FLEET BY FEDERATION COUNCIL APPROPRIATION. THE VESSELS WERE CONVERTED EITHER FROM THE ORIGINAL CONSTITUTION CONFIGURATION OR THEIR PREVIOUS OPERATIONAL STANDARD.

USS CONSTELLATION	NCC-1017	USS EXCALIBUR	NCC-1705
USS CONSTITUTION	NCC-1700	USS EXTER	NCC-1706
USS ENTERPRISE	NCC-1701	USS HOOD	NCC-1707
USS FARRAGUT	NCC-1702	USS INTREPID	NCC-1708
USS LEXINGTON	NCC-1703	USS KONGO	NCC-1710
USS YORKTOWN	NCC-1704		

GENERAL INFORMATION

By 2249, the Constitution production run had been completed; 14 Project Starship heavy cruisers were either pushing the far-flung borders of the Federation or making their way in those directions. Around thirty years after initial conception, the plan had been fully realized and Star Fleet was moving on with its adopted policies of power projection, complete defense, exploration, and diplomacy. One vessel, USS Valiant (NCC-1709), had gone missing in action early in her post-commissioning familiarization run in 2247, but the remainder had reported no technical concerns that would impact survivability. Point-in-fact, the ships were already receiving a great deal of attention domestically and externally, from the press, in the diplomatic corps, and by many disparate scientific circles that were quite impressed with the data streaming back in from the distant voyagers.

While there had been little concern with major technical issues on board the ships, technological progress had marched on; advancements in phased energy rectification introduced a new generation in directed-energy weapons. The newer, more precise phasers made moderated use of the rapid nadian effect of subatomic particles—via plasma—interacting within atomic nuclei to put a wide range of energy effects on a target, from stun (on certain organisms) to heating or even complete disruption of a cellular structure through disintegration. These weapons were now determined to be viable replacements, or—more specifically—far better successors to the centuries' old use of lasers. The development of the heavy phased particle cannons was appearing to plateau at the same time, and the decision was made to remove both systems from the Constitutions.

Several other technical concepts had been suggested for the heavy cruisers; their apparent popularity as a multi-mission platform had led to tremendous support for a second production run of another 14 vessels with those improvements built in. The logical process would be to build the new vessels and then swap them out with the deployed ones, but the high confidence (and demand) for the advanced phasers led to a plan wherein the original ships would be brought in for upgrade periods that were scheduled to take no longer than 3 months, pulling out the lasers and plasma cannons, installing the phaser banks, and keeping the off-station time of the individual vessels to a minimum. This would allow these upgraded vessels to return to their patrols and missions months before the planned Bonhomme Richard subclass would be operational.



CONSTITUTION FLIGHT II GENERAL INFORMATION (CONTINUED)

USS Excalibur (NCC-1705), operating antispinward of the Federation in the direction of the Klingon Empire, was the first to be re-called to her operating starbase in 2250. The weapons conversion teams had been training for her arrival, and within 12 hours of the ship being placed into cold status (depowering her warp core and relying on the station to provide shore power to systems other than tactical and propulsion), they were prying the 4.0 GW lasers out and installing six Type VII phaser emitters into new retractable bays on the dorsal sides and a pair of smaller bays flanking the ventral torpedo launcher. The heavy plasma cannons were removed shortly thereafter, with new hull sections rapidly welded to cover the gaps. Three engineering teams also took on the challenge of removing the antimatter storage facility located on the ventral secondary hull (along with the ejection port) and installing more traditional fueling apparatus in the nacelle pylons, all within the allotted time. While—again—none of the Constitutions' commanding officers nor chief engineers reported any concerns with new equipment not being ready, one theory was that the inexplicable loss of Valiant might have been because of a faulty transmission function within that system. Better remove it than risk the entire series of ships, it was thought.

By the end of 2256, USS Constitution (NCC-1700) and USS Constellation (NCC-1017) had gone through extensive upgrade periods to achieve full parity with the nine other ships of the Flight II standard. USS Republic (NCC-1371) was not deemed a viable candidate for inclusion, as she was wrapping up her assignment as the class training vessel and scheduled for decommissioning the next year. Due to operational commitments, USS Potemkin (NCC-1711) would skip this intermittent step to the Bonhomme Richard standard.

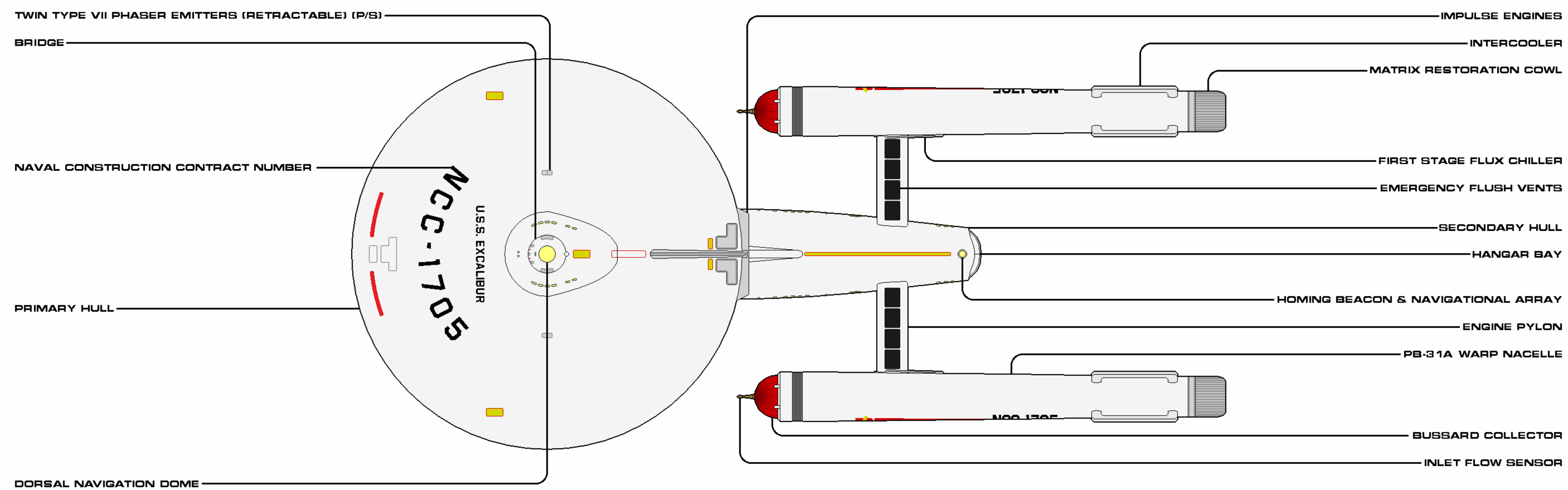
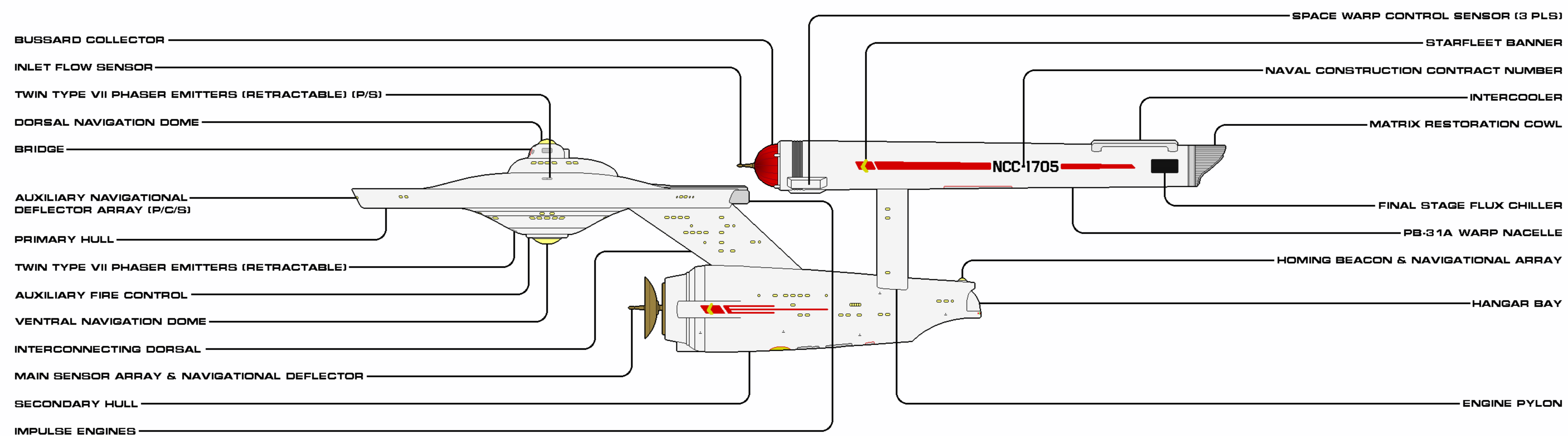

SHEET 1 OF 2

CLASS	CONSTITUTION	CATEGORY	HEAVY CRUISER
VARIANT	FLIGHT II	MODIFIED	2251
LENGTH	288.6 M	BEAM	121.1 M
HEIGHT	12.6 M	MASS	680,100 MT
OPERATIONAL	II	RELEASE DATE	2002.05

Authorized for release by Star Fleet Bureau of Starship Construction

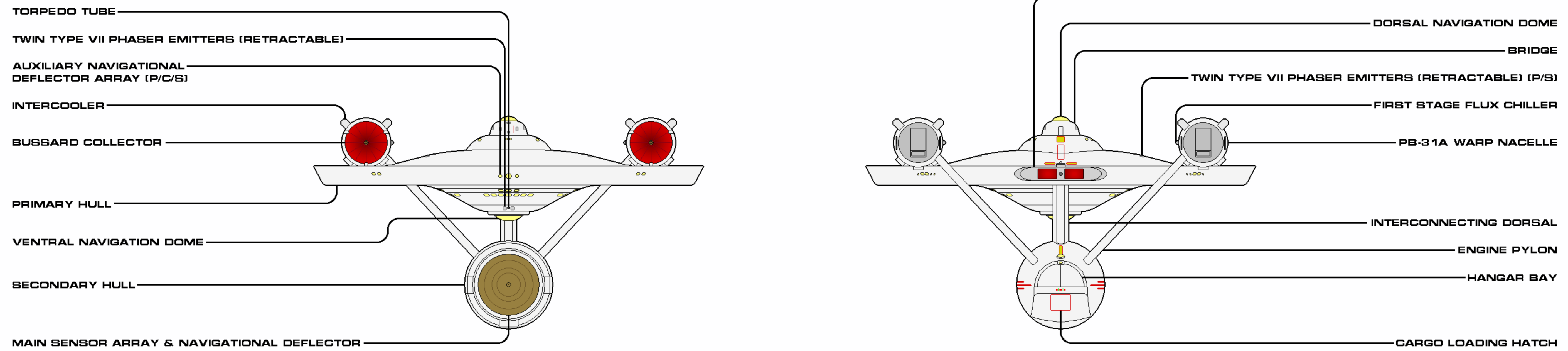
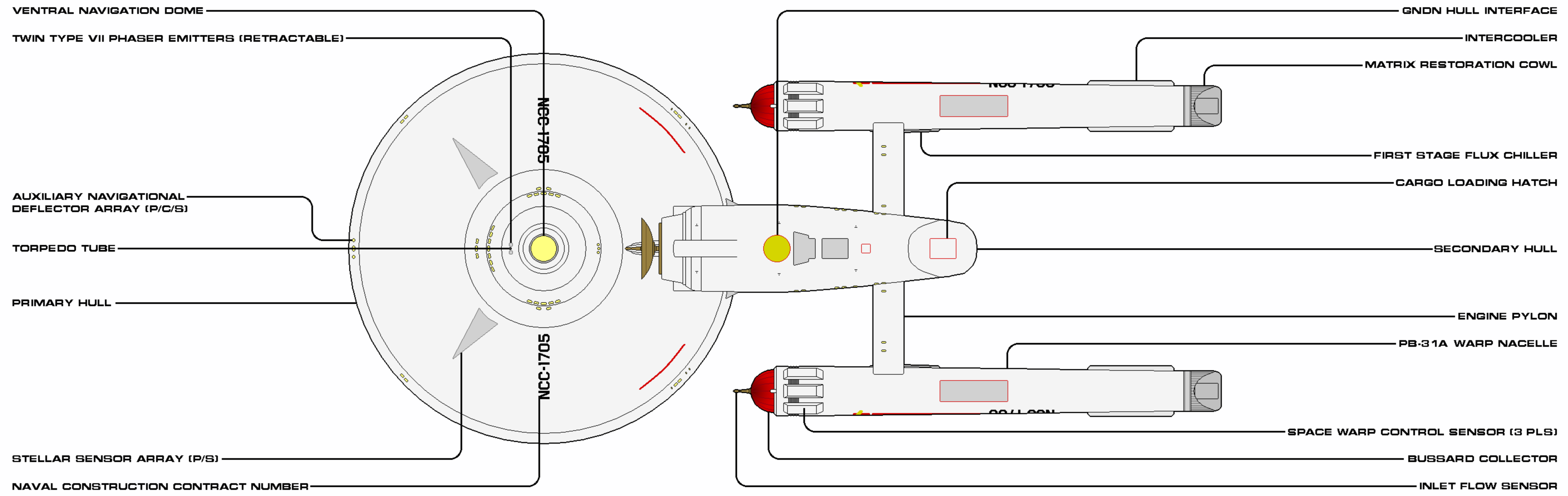

SHEET 2 OF 2

CLASS	CONSTITUTION	CATEGORY	HEAVY CRUISER
VARIANT	FLIGHT II	CONSTRUCTED	2251
LENGTH	208.6 M	BEAM	121.1 M
HEIGHT	12.6 M	MASS	600,100 MT
OPERATIONAL	11	RELEASE DATE	2002.05

Authorized for release by Star Fleet Bureau of Starship Construction

BONHOMME RICHARD SUBCLASS

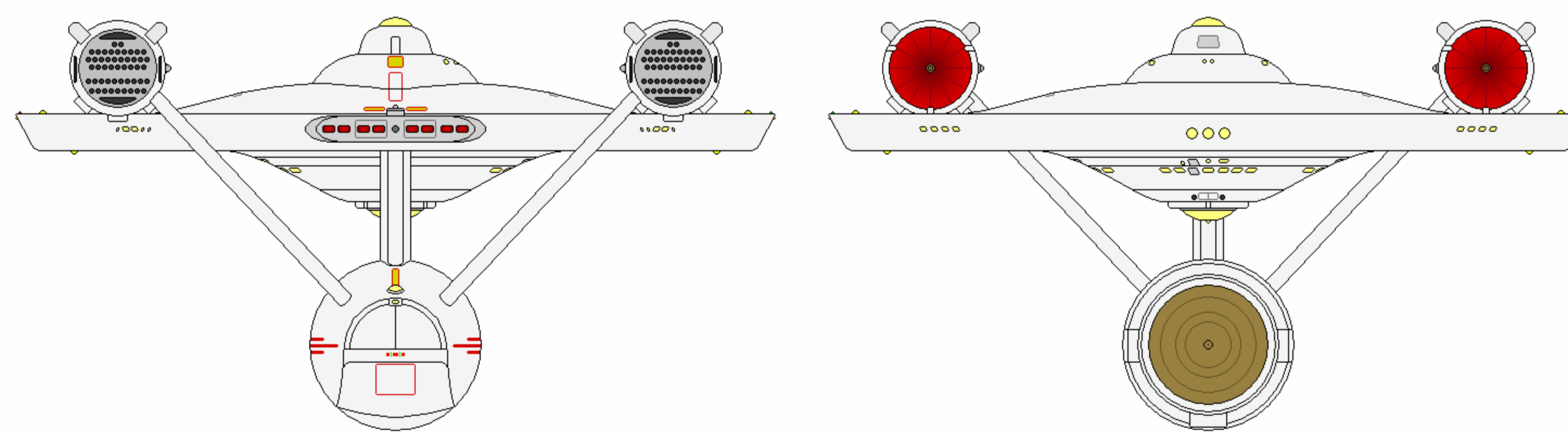
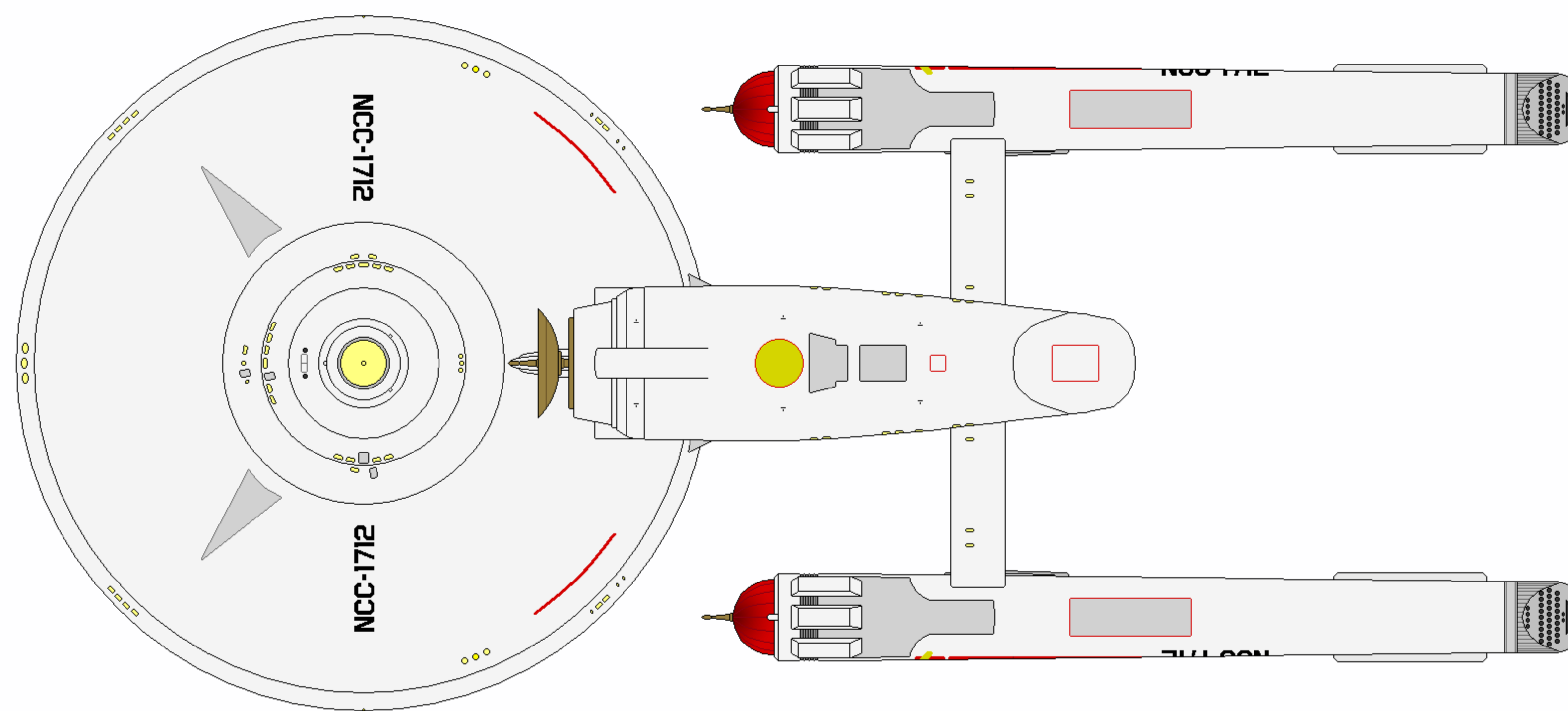
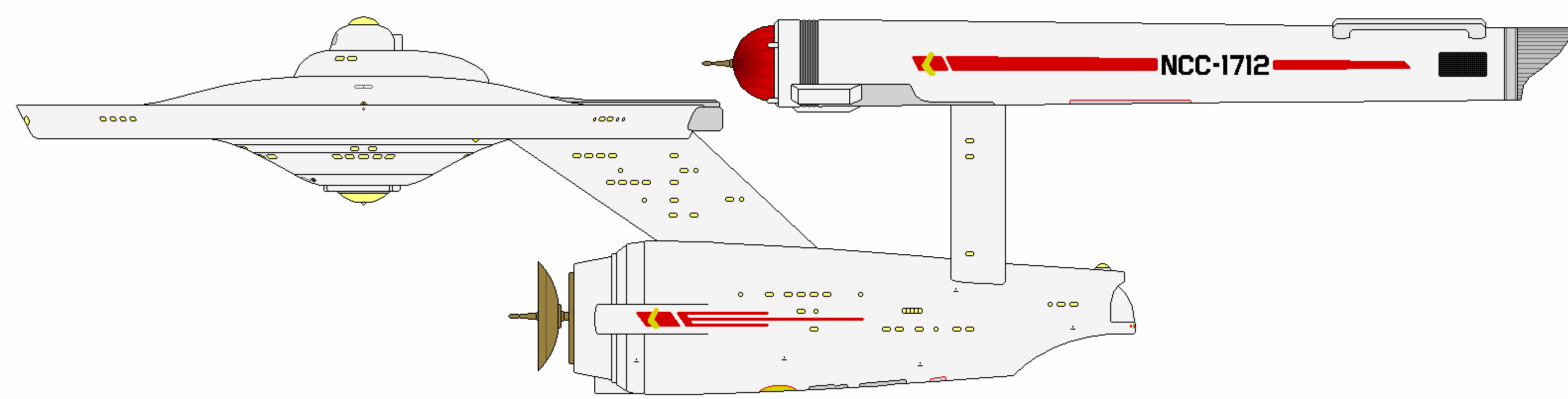
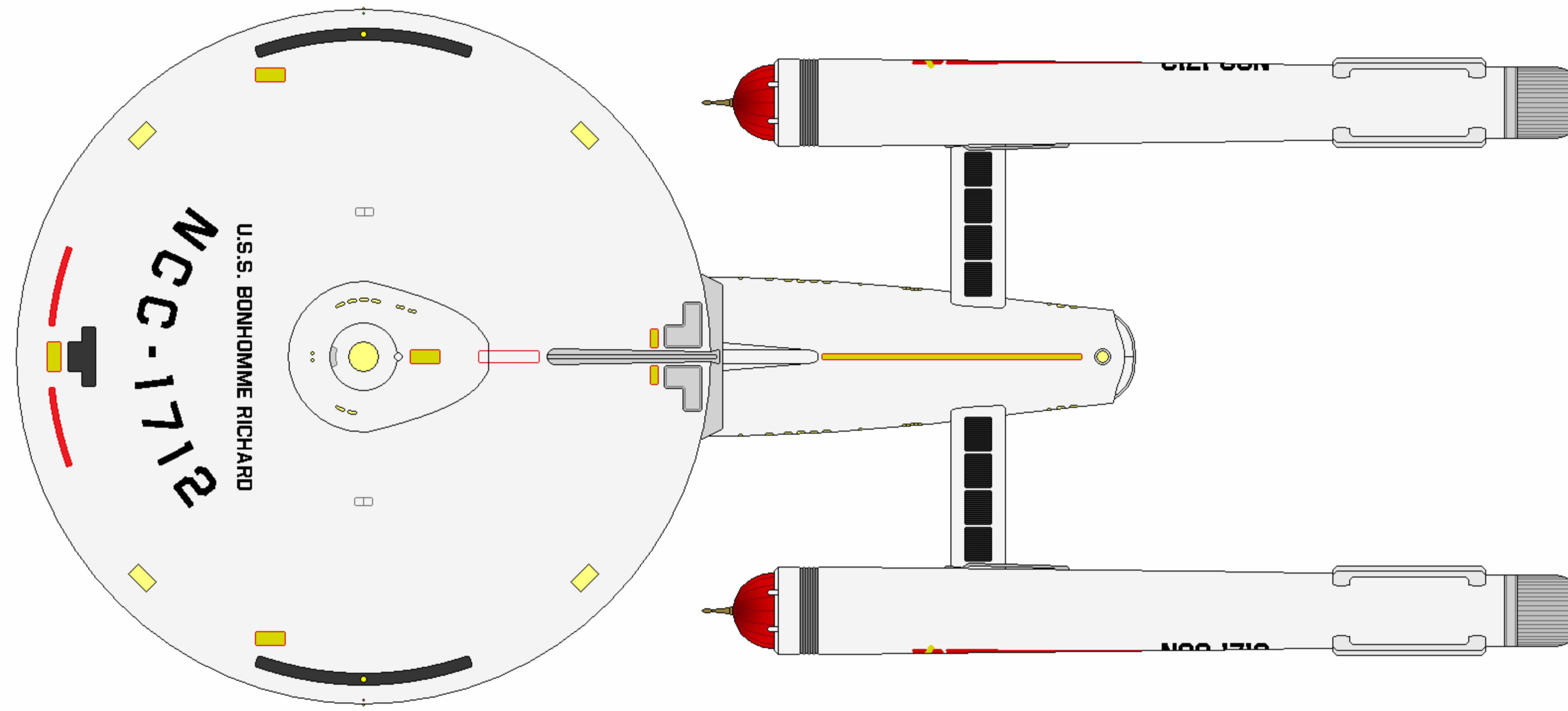



BONHOMME RICHARD SUBCLASS

CATEGORY:	HEAVY CRUISER		
OPERATIONAL:	2251 - 2264		
CONSTRUCTED:	22 (16 NEWBUILDS, 1 CONSTITUTION, 5 CONSTITUTION FLIGHT II)		
DIMENSIONS:		TACTICAL:	
LENGTH:	288.6 M	- 6X TYPE VII PHASER EMITTERS	
BEAM:	127.1 M	- 2X MEDIUM TORPEDO TUBES	
HEIGHT:	72.6 M	(W/ 80 PHOTON TORPEDOES)	
MASS:	682,000 MT	- 1-LAYER CONFORMAL FORCEFIELD	
		- 1X PRIMARY NAVIGATIONAL DEFLECTOR	
		- 3X AUXILIARY NAVIGATIONAL DEFLECTORS	
PERFORMANCE:			
CRUISE:	WARP 6 (OCU)		
MAX:	WARP 8 (OCU)		
ENDURANCE:	5 YEARS		
COMPLEMENT:		AUXILIARIES:	
OFFICERS:	50	- 1X HEAVY SHUTTLE	
ENLISTED:	293	- 2-4X LIGHT SHUTTLES	
		- 4X SHUTTLEPODS	
		- 4X WORK PODS	
		- VARIOUS SPECIAL ENVIRONMENT/TACTICAL CRAFT	

AUTHORIZED CONSTRUCTION

THE FOLLOWING SHIPS OF THE ABOVE CLASS WERE AUTHORIZED AS PART OF THE FEDERATION STAR FLEET BY FEDERATION COUNCIL APPROPRIATION. THE VESSELS WITH REGISTRIES PRIOR TO 1712 WERE CONVERTED FROM EITHER THE ORIGINAL CONSTITUTION CONFIGURATION (NCC-1711) OR FROM THE CONSTITUTION FLIGHT II CONFIGURATION.

USS CONSTELLATION	NCC-1017	USS DEFIANCE	NCC-1717
USS CONSTITUTION	NCC-1700	USS EXCELSIOR	NCC-1718
USS YORKTOWN	NCC-1704	USS EAGLE	NCC-1719
USS EXCALIBUR	NCC-1705	USS LAFAYETTE	NCC-1720
USS KONGO	NCC-1710	USS WASP	NCC-1721
USS POTEKIN	NCC-1711	USS EL DORADO	NCC-1722
USS BONHOMME RICHARD	NCC-1712	USS ARI	NCC-1723
USS MONITOR	NCC-1713	USS SARATOGA	NCC-1724
USS HORNET	NCC-1714	USS TORI	NCC-1725
USS MERRIMAC	NCC-1715	USS KRIEGER	NCC-1726
USS ENDEAVOR	NCC-1716	USS ESSEX	NCC-1727

GENERAL INFORMATION

The USS Bonhomme Richard (NCC-1712) headlined a subclass of the Constitution heavy cruisers because it was not yet clear if, at the time of funding appropriation in 2249, the 13 members of the original builds would be converted into the new standard or remain within their own branch of upgraded flights. The 14 ships authorized under the new subclass had the identical directed energy weapons upgrade as the concurrent Constitution Flight IIs, but also an expanded torpedo bay supporting an additional launch tube in the ventral saucer. Some modernized equipment that would not be easily installed on pre-existing ships was also included, such as the dorsal-mounted MAUM sensor suite, updated inertial stabilizers, and more powerful auxiliary navigational deflectors.

The subclass entered Star Fleet service in 2251, and as the final ships were nearing completion in 2254, their dependability was so appreciated the decision was made to bring the Constitution Flight IIs up to the same standard. Enough time was scheduled for the more extensive yard periods necessary to add in the updated equipment and two more new-builds (USS Krieger and USS Essex, NCC-1726 and -1727 respectively) were also authorized. Six select units of the original ships were given additional phaser coverage: three vessels, referred to as Type 2, received two single type VI phaser emitters on the ventral secondary hull, and another set (Type 3) had four type VII phaser mounts installed on the saucer: two singles on the dorsal sides and one forward bank located directly beneath the bridge. The Type 3 mounts were discontinued with the follow-on Constitution Flight III configuration.

Because the subclass was authorized prior to the decision to include USS Constitution by almost 11 full years, the name did not change when she was herself upgraded to the standard in 2260.

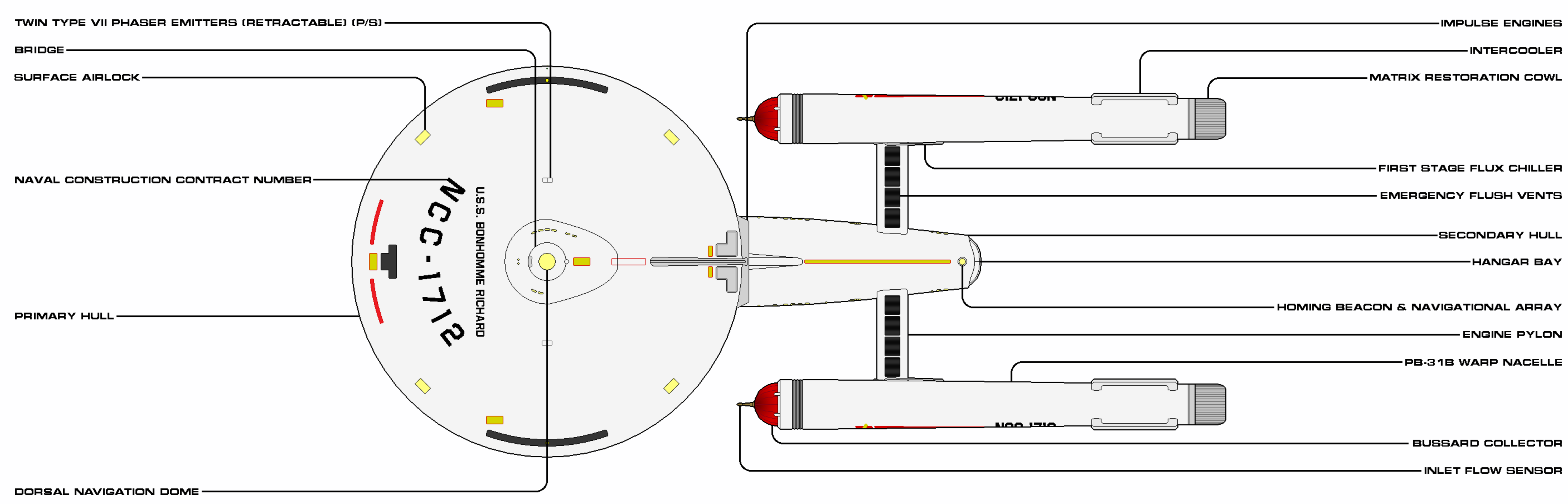
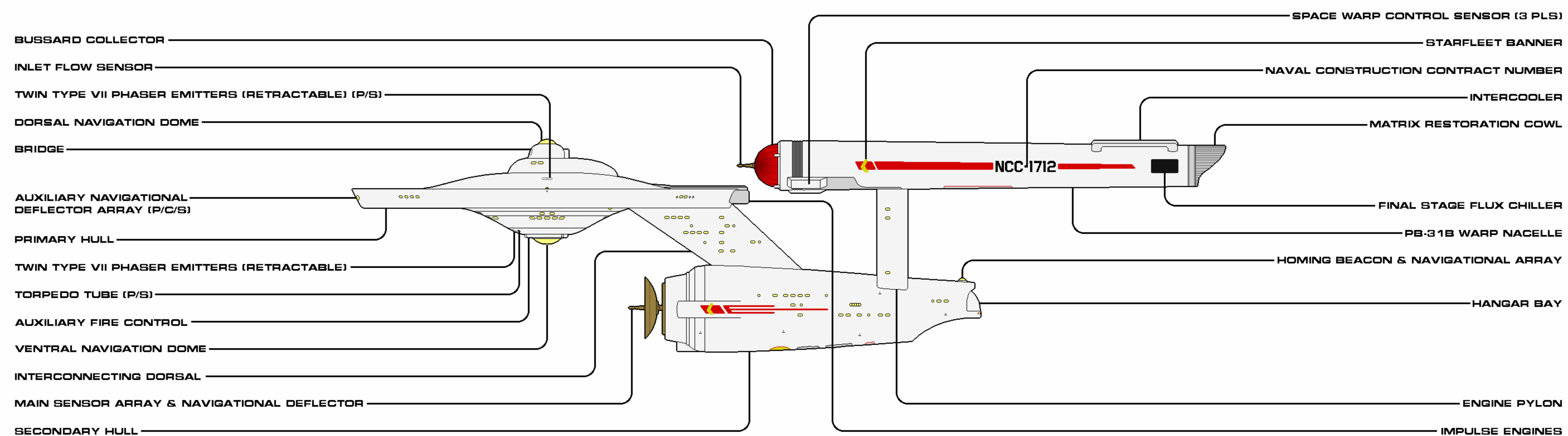

SHEET 1 OF 2

CLASS	CONSTITUTION	CATEGORY	HEAVY CRUISER
VARIANT	BONHOMME RICHARD	CONSTRUCTED	2251
LENGTH	288.6 M	BEAM	121.1 M
HEIGHT	12.6 M	MASS	682,000 MT
OPERATIONAL	22	RELEASE DATE	2002.05

Authorized for release by Star Fleet Bureau of Starship Construction



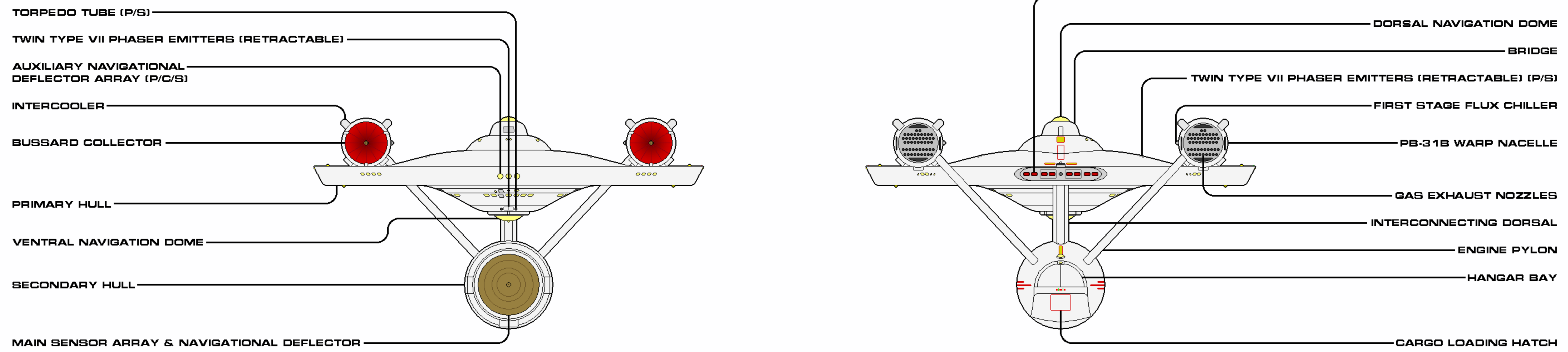
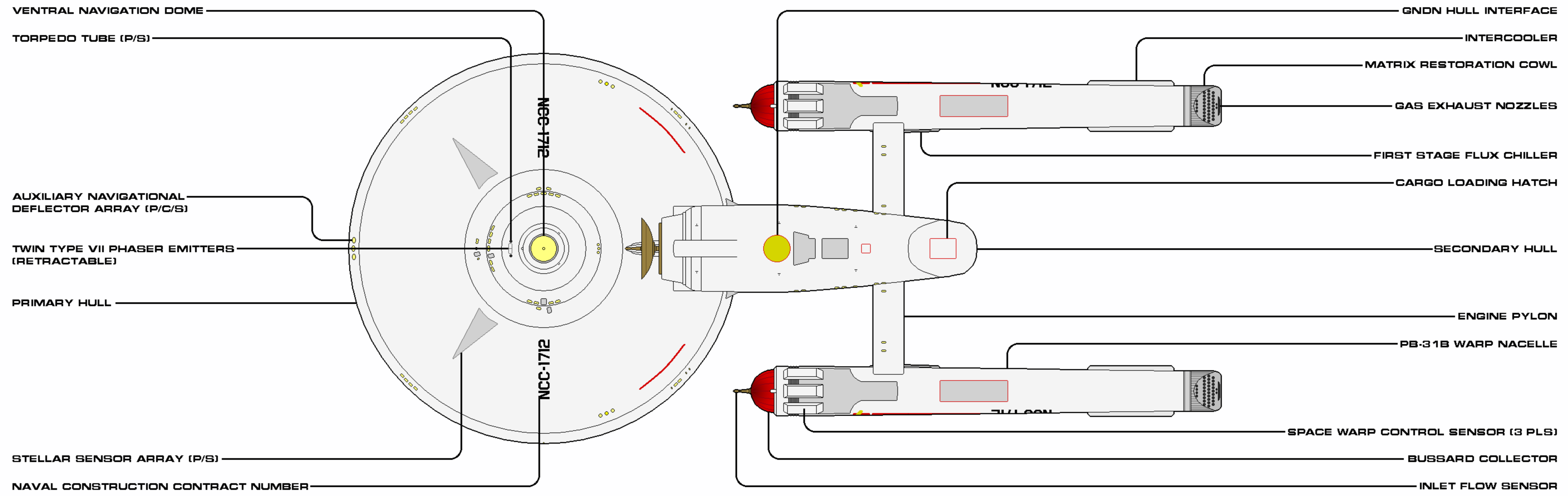

SHEET 2 OF 2

CLASS	CONSTITUTION	CATEGORY	HEAVY CRUISER
VARIANT	BONHOMME RICHARD	CONSTRUCTED	2251
LENGTH	208.6 M	BEAM	121.1 M
HEIGHT	12.6 M	MASS	602,000 MT
OPERATIONAL	22	RELEASE DATE	2002.05

Authorized for release by Star Fleet Bureau of Starship Construction



BONHOMME RICHARD SUBCLASS (TYPE 2)

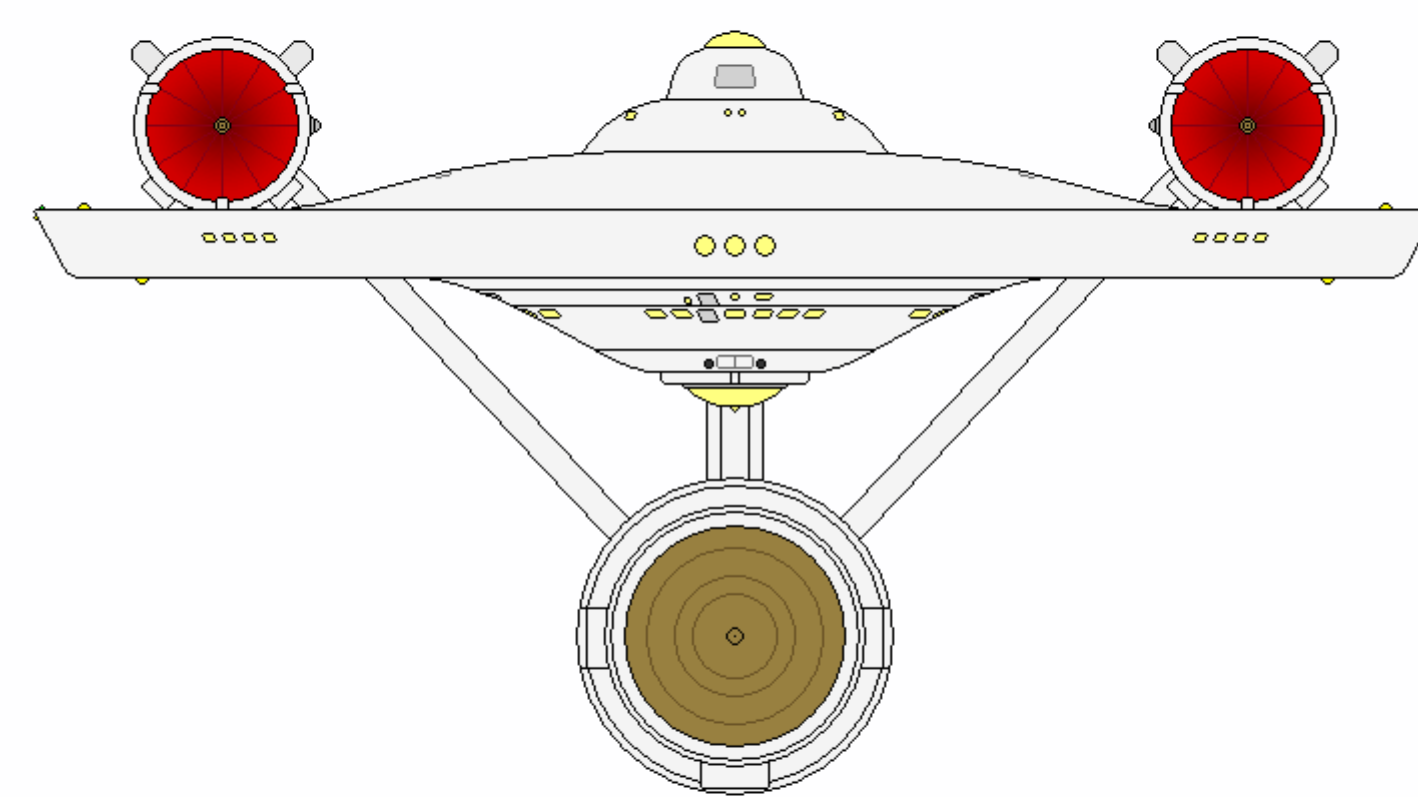
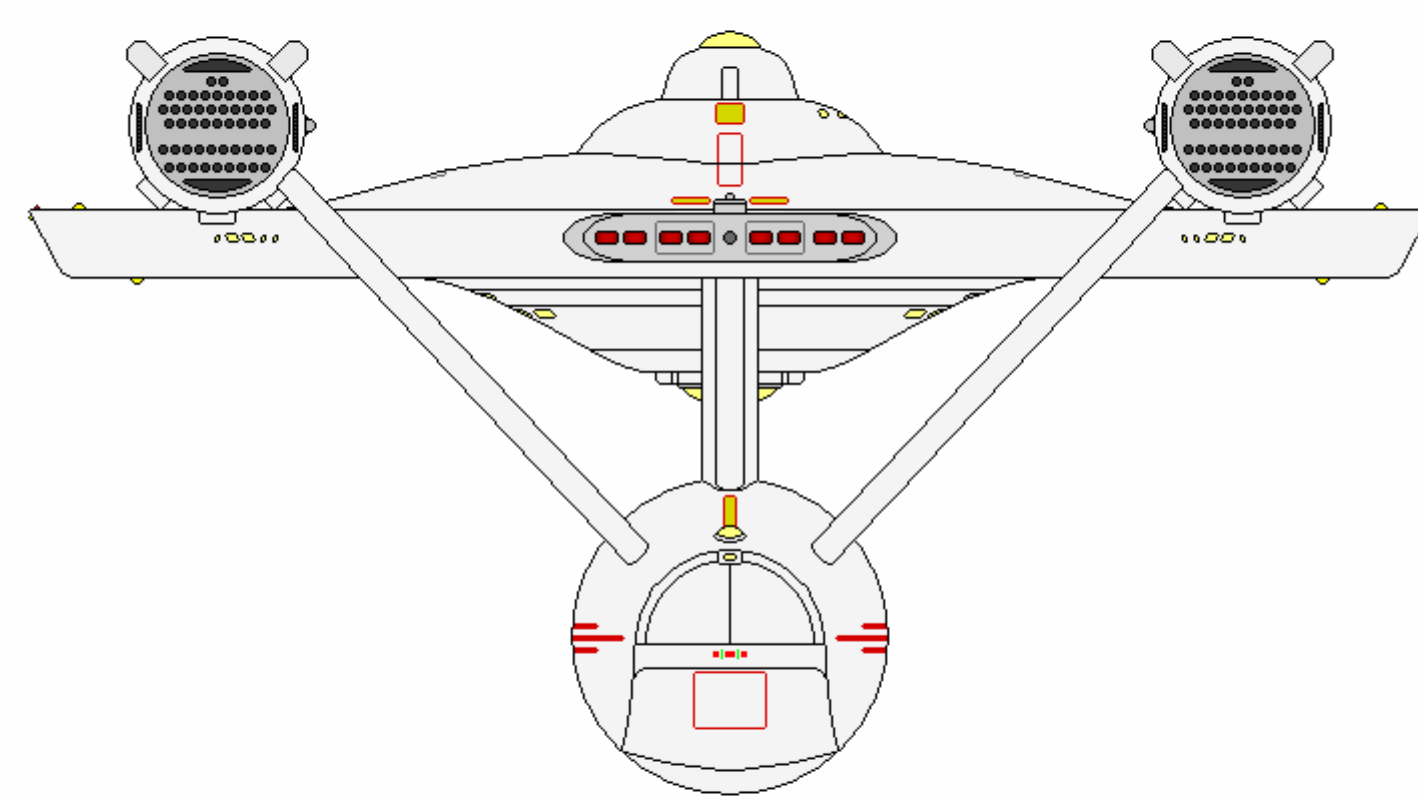
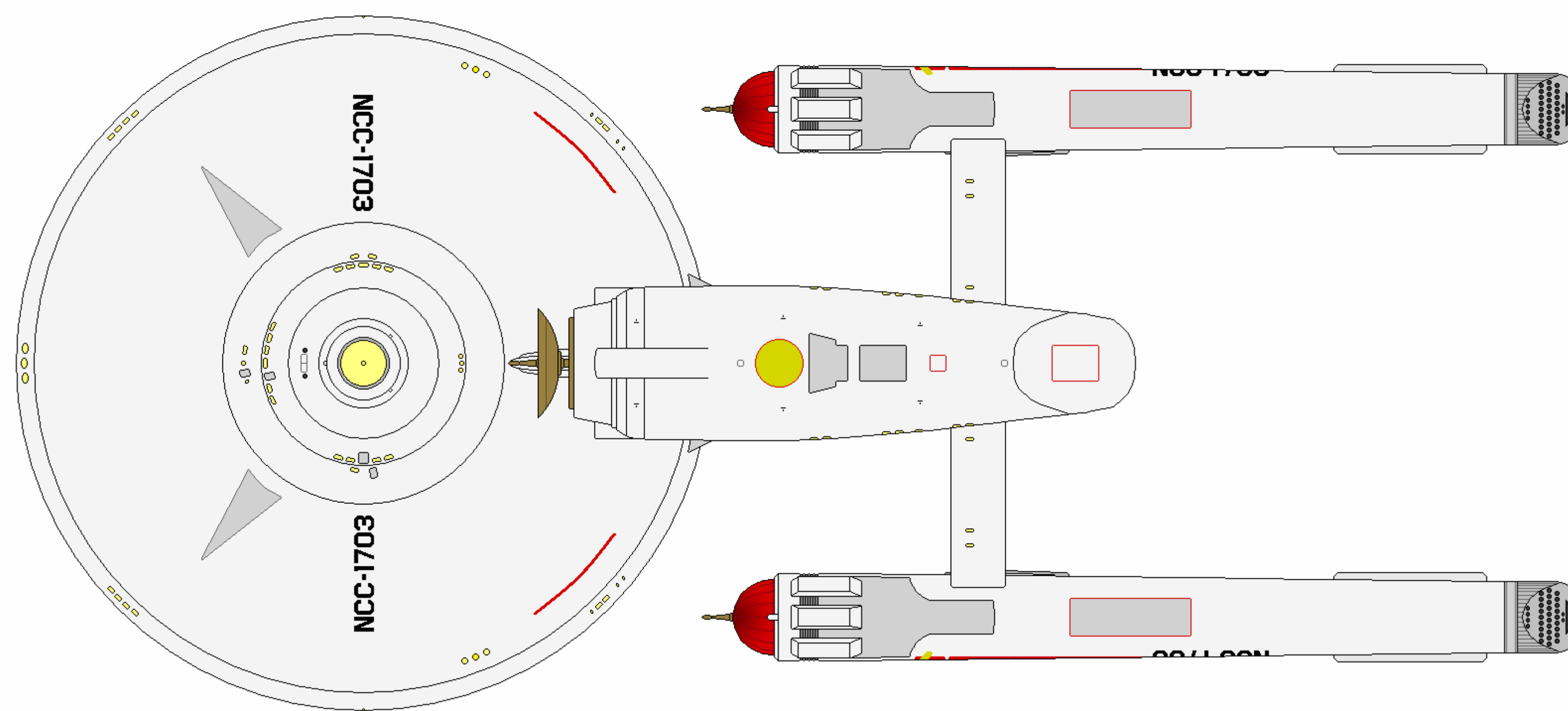
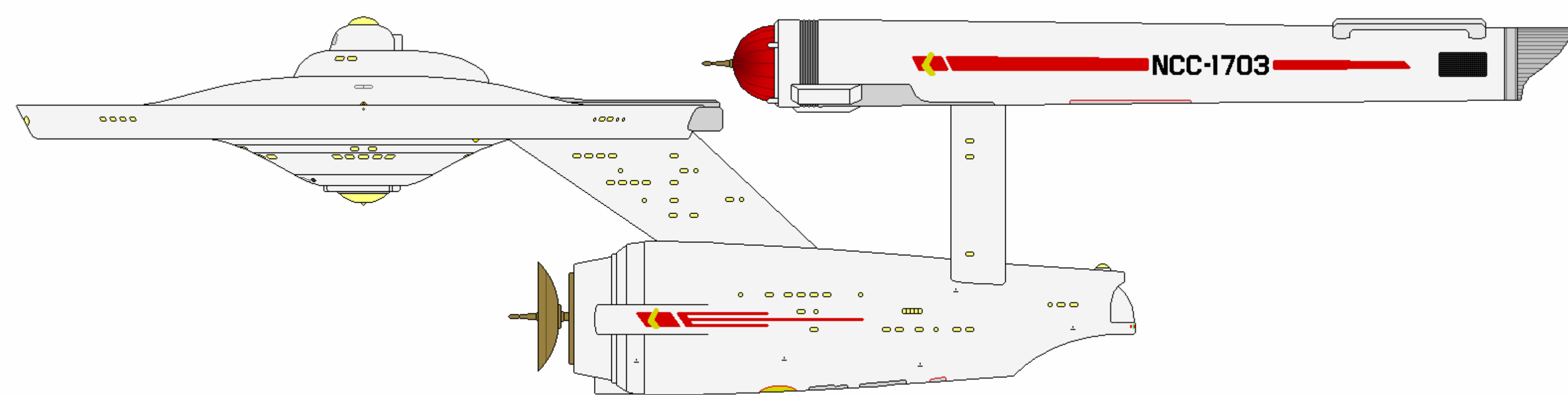
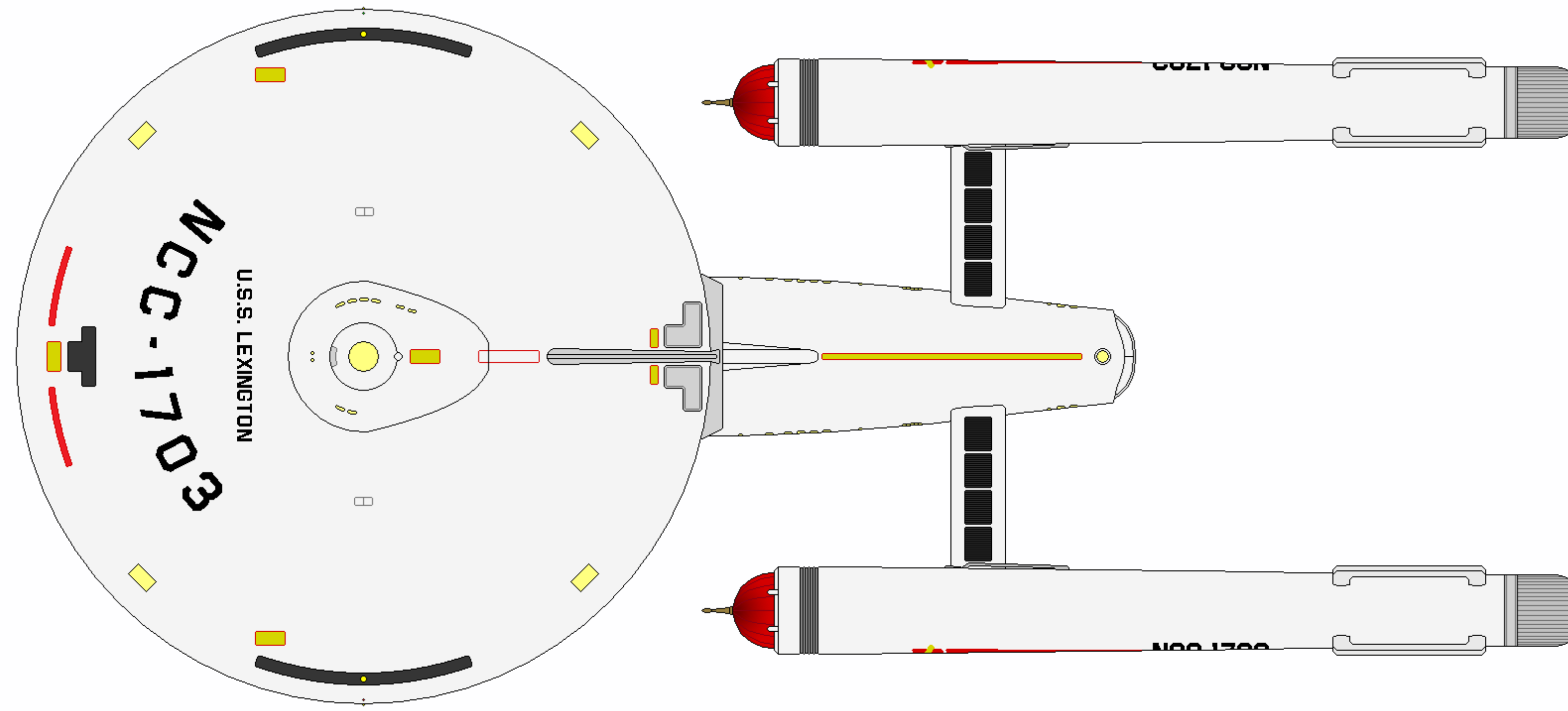



BONHOMME RICHARD SUBCLASS (TYPE 2)

CATEGORY:	HEAVY CRUISER		
OPERATIONAL:	2256 - 2264		
MODIFIED:	3 (CONSTITUTION FLIGHT II)		
DIMENSIONS:		TACTICAL:	
LENGTH:	288.6 M	- 6X TYPE VII PHASER EMITTERS	
BEAM:	127.1 M	- 2X TYPE VI PHASER EMITTERS	
HEIGHT:	72.6 M	- 2X MEDIUM TORPEDO TUBES	
MASS:	683,500 MT	(W/ 80 PHOTON TORPEDOES)	
		- 1-LAYER CONFORMAL FORCEFIELD	
PERFORMANCE:		- 1X PRIMARY NAVIGATIONAL DEFLECTOR	
CRUISE:	WARP 6 (OCU)	- 3X AUXILIARY NAVIGATIONAL DEFLECTORS	
MAX:	WARP 8 (OCU)		
ENDURANCE:	5 YEARS		
COMPLEMENT:		AUXILIARIES:	
OFFICERS:	50	- 1X HEAVY SHUTTLE	
ENLISTED:	293	- 2-4X LIGHT SHUTTLES	
		- 4X SHUTTLEPODS	
		- 4X WORK PODS	
		- VARIOUS SPECIAL ENVIRONMENT/TACTICAL CRAFT	

AUTHORIZED CONSTRUCTION

THE FOLLOWING SHIPS OF THE ABOVE CLASS WERE AUTHORIZED AS PART OF THE FEDERATION STAR FLEET BY FEDERATION COUNCIL APPROPRIATION. THE VESSELS WERE CONVERTED FROM THE CONSTITUTION FLIGHT II CONFIGURATION.

USS ENTERPRISE	NCC-1701	USS LEXINGTON	NCC-1703
USS FARRAGUT	NCC-1702		

GENERAL INFORMATION

The flexibility of the relatively new phaser technology offered an enormous number of tactical choices, both offensive and defensive. A Star Fleet tactical review board chose to explore the potential of differing weapons loadouts on the Bonhomme Richard subclass for possible inclusion with future configurations of the Constitutions (and others). Of the ideas suggested, only two were approved for test runs on the Constitution Flight IIs being upgraded to the Bonhomme Richard standard. Three vessels were selected for each different loadout, with the ships sub-categorized as either Type 2 or Type 3 (the original production run and remaining upgraded vessels were referred to simply as Bonhomme Richards).

The Type 2 added two single phaser mounts (of the type VI variety) to the ventral side of the secondary hull, providing additional protective coverage to that critical portion of the ship's engineering superstructure. These were known as the amidship mounts. The Type 3 was a bit more radical: phaser VI emitters were added—as a twin bank—onto the dorsal saucer, further back from the standard position on the Constitution series, but located between decks 2 & 3, directly beneath the bridge. The Type VII phaser bank was separated, with one mount placed on either side of the bridge module, on the saucer proper. It was thought this would provide better coverage against attackers moving fore-to-aft or aft-to-fore, as well as bringing another full bank to bear at some point on the attacking exchange. However, only the amidship phasers went on to become a permanent fixture of future starship generations.

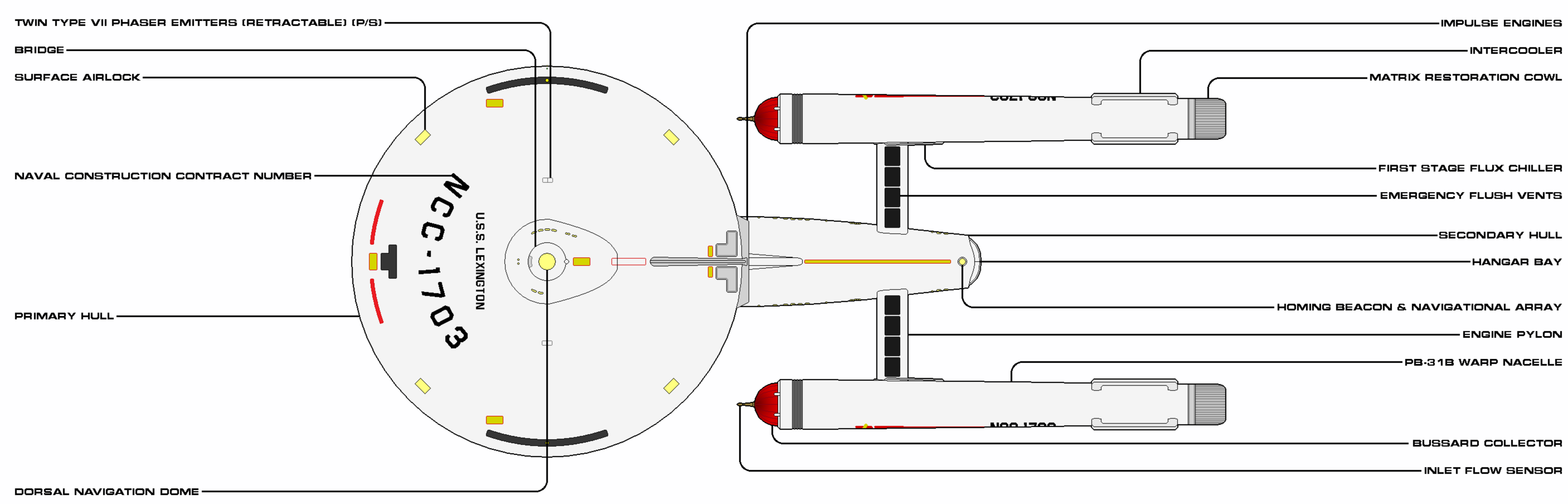
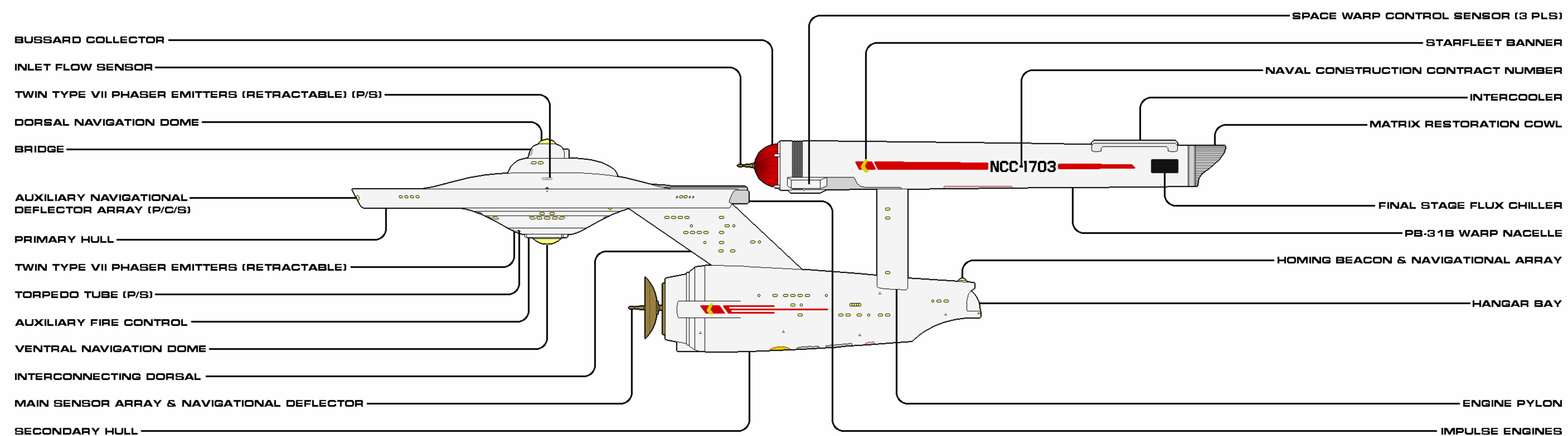

SHEET 1 OF 2

CLASS	CONSTITUTION	CATEGORY	HEAVY CRUISER
VARIANT	BR TYPE 2	CONSTRUCTED	2251
LENGTH	288.6 M	BEAM	121.1 M
HEIGHT	12.6 M	MASS	683,500 MT
OPERATIONAL	3	RELEASE DATE	2002.05

Authorized for release by Star Fleet Bureau of Starship Construction

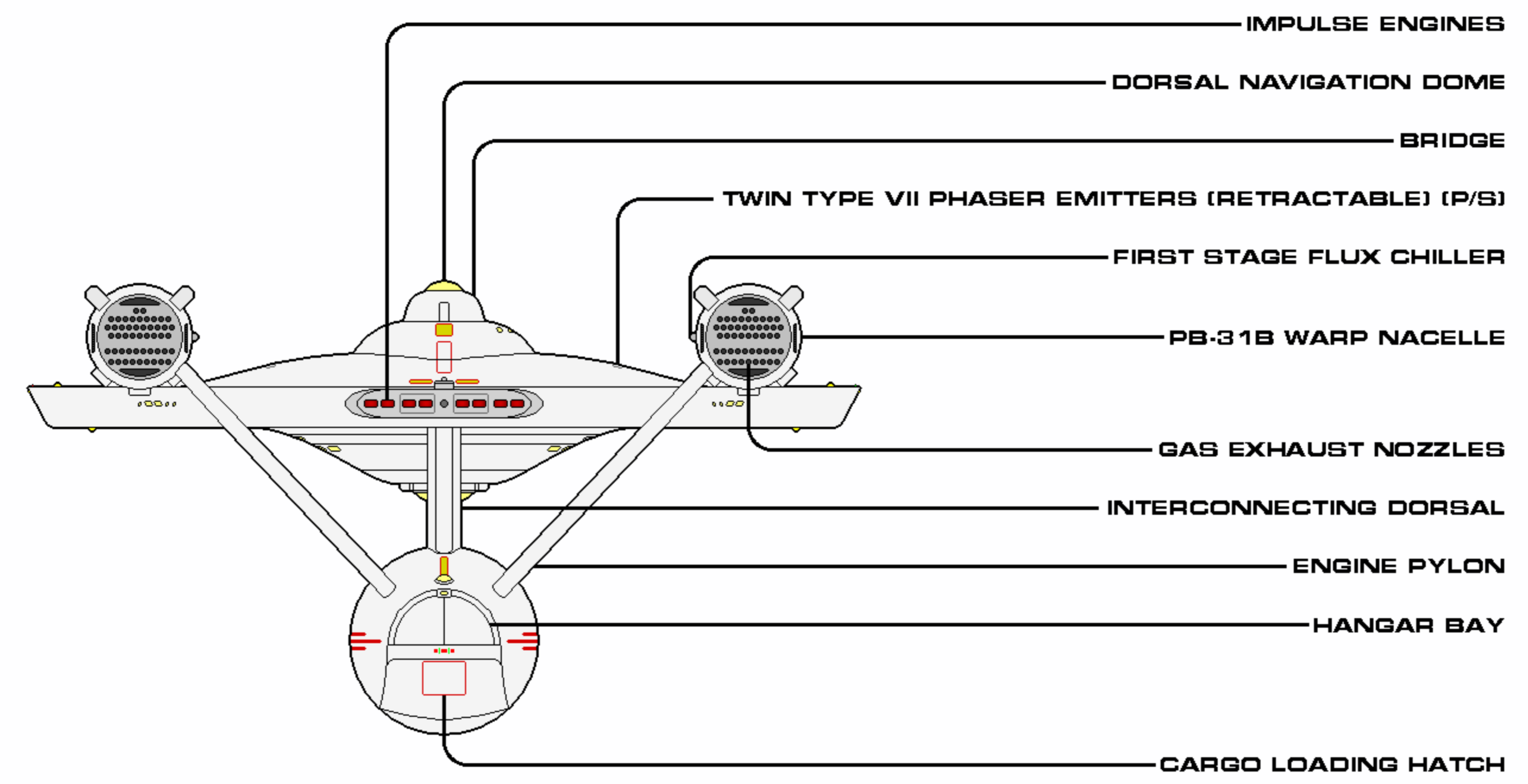
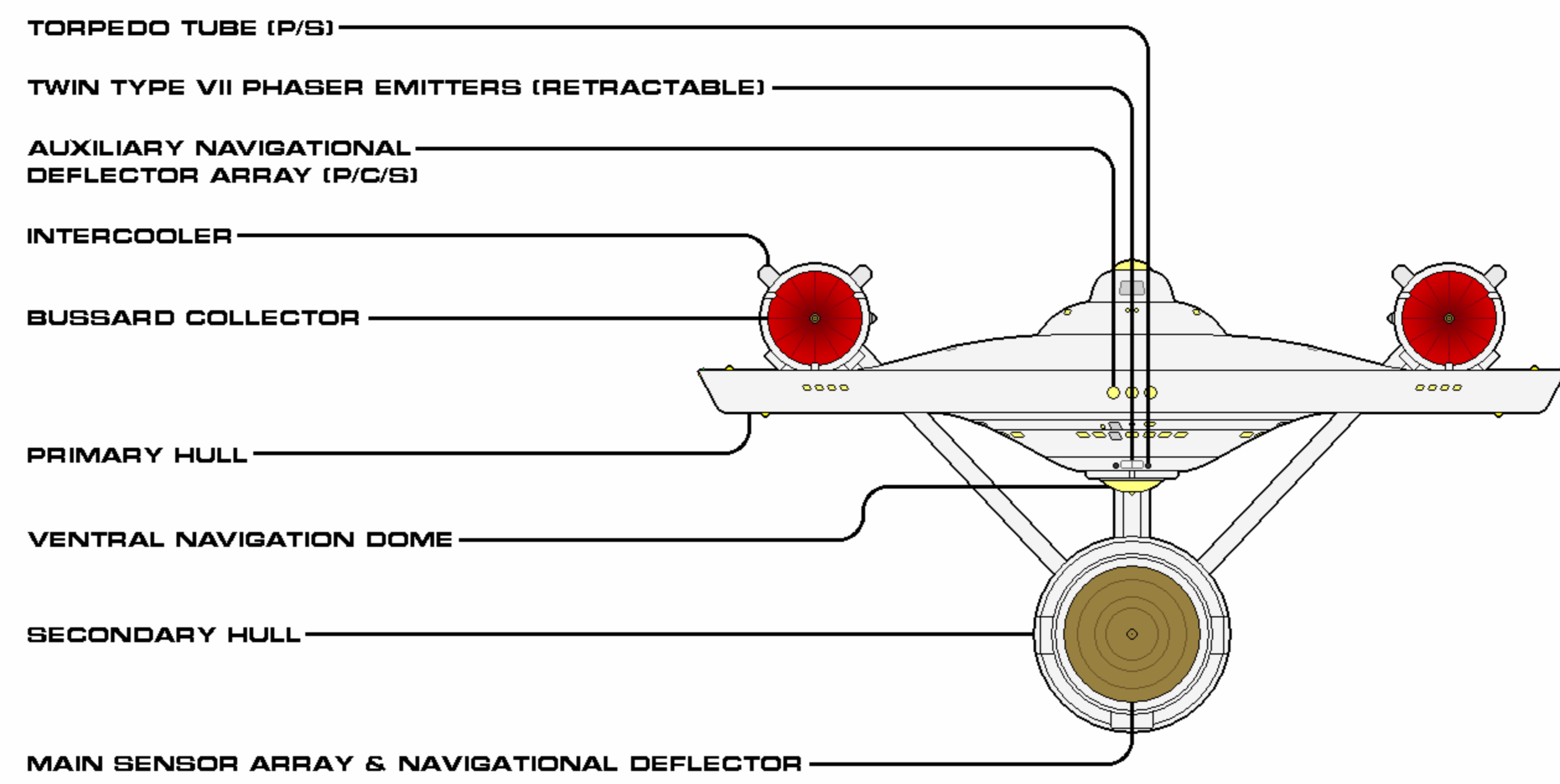
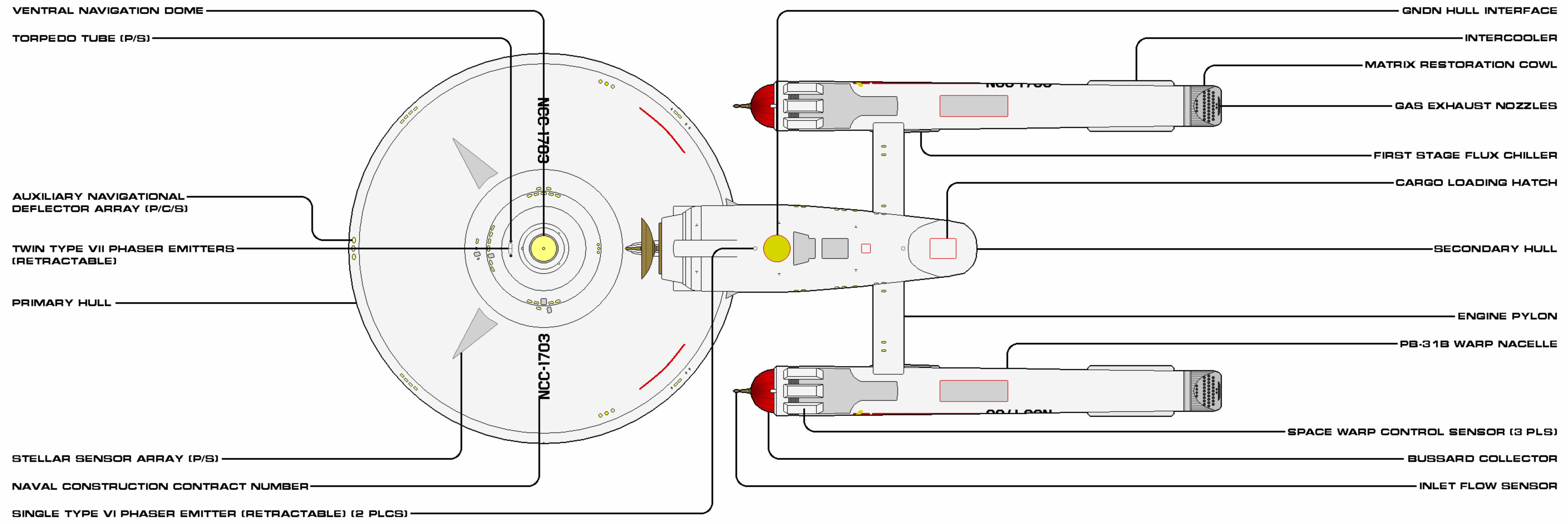

SHEET 2 OF 2

CLASS CONSTITUTION	CATEGORY HEAVY CRUISER
VARIANT BR TYPE 2	CONSTRUCTED 2251
LENGTH 208.6 M	BEAM 121.1 M
HEIGHT 12.6 M	MASS 603,500 MT
OPERATIONAL 3	RELEASE DATE 2002.05

Authorized for release by Star Fleet Bureau of Starship Construction



BONHOMME RICHARD SUBCLASS (TYPE 3)

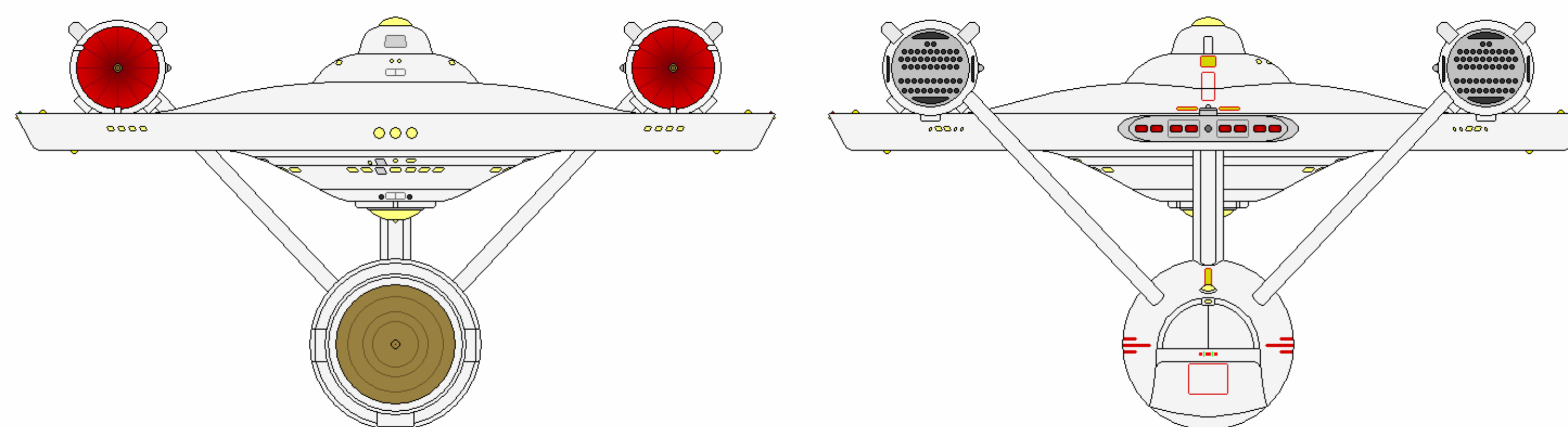
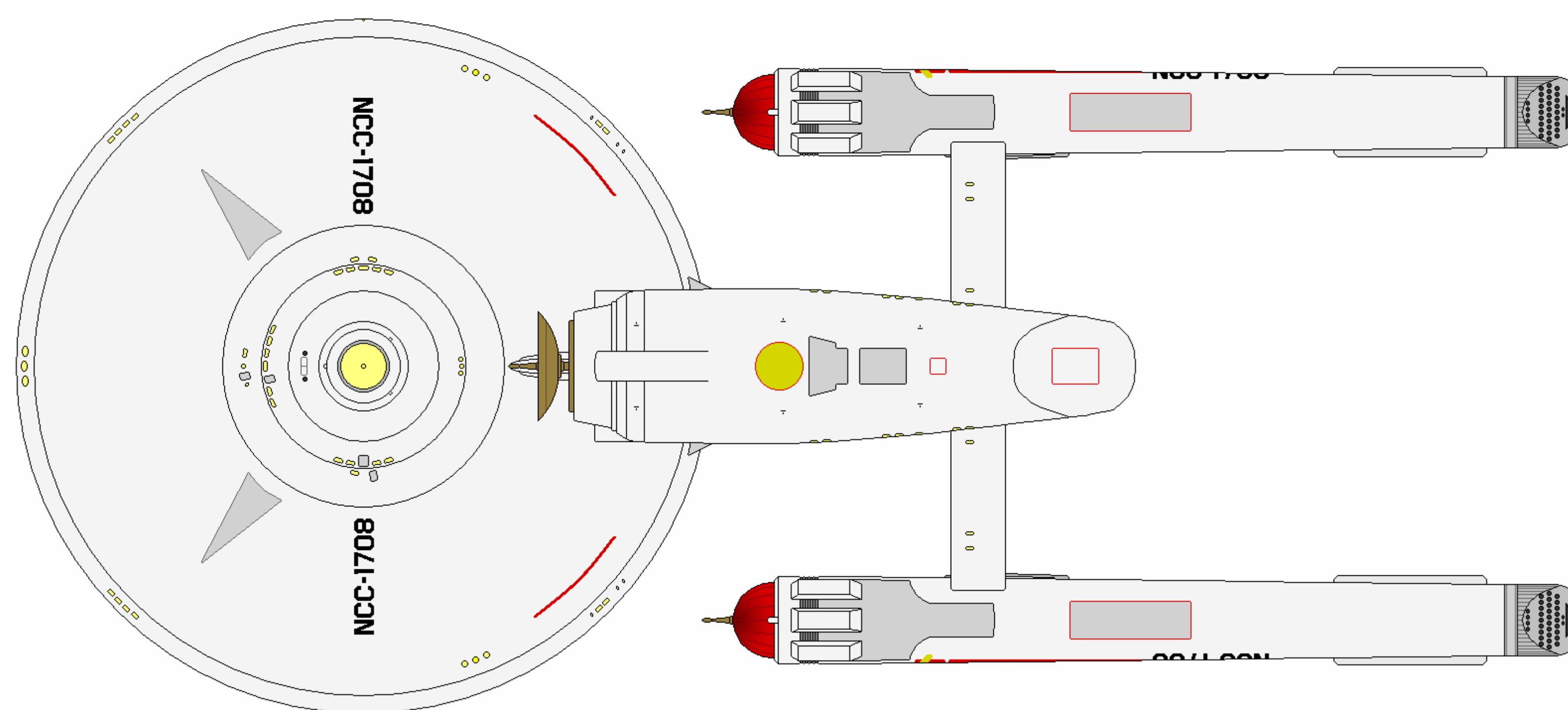
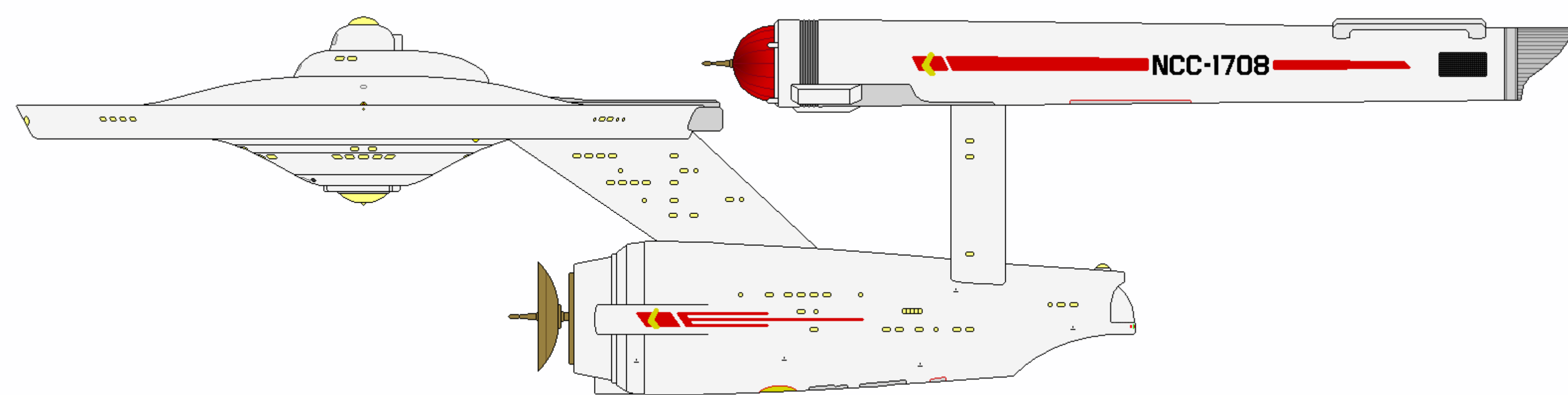
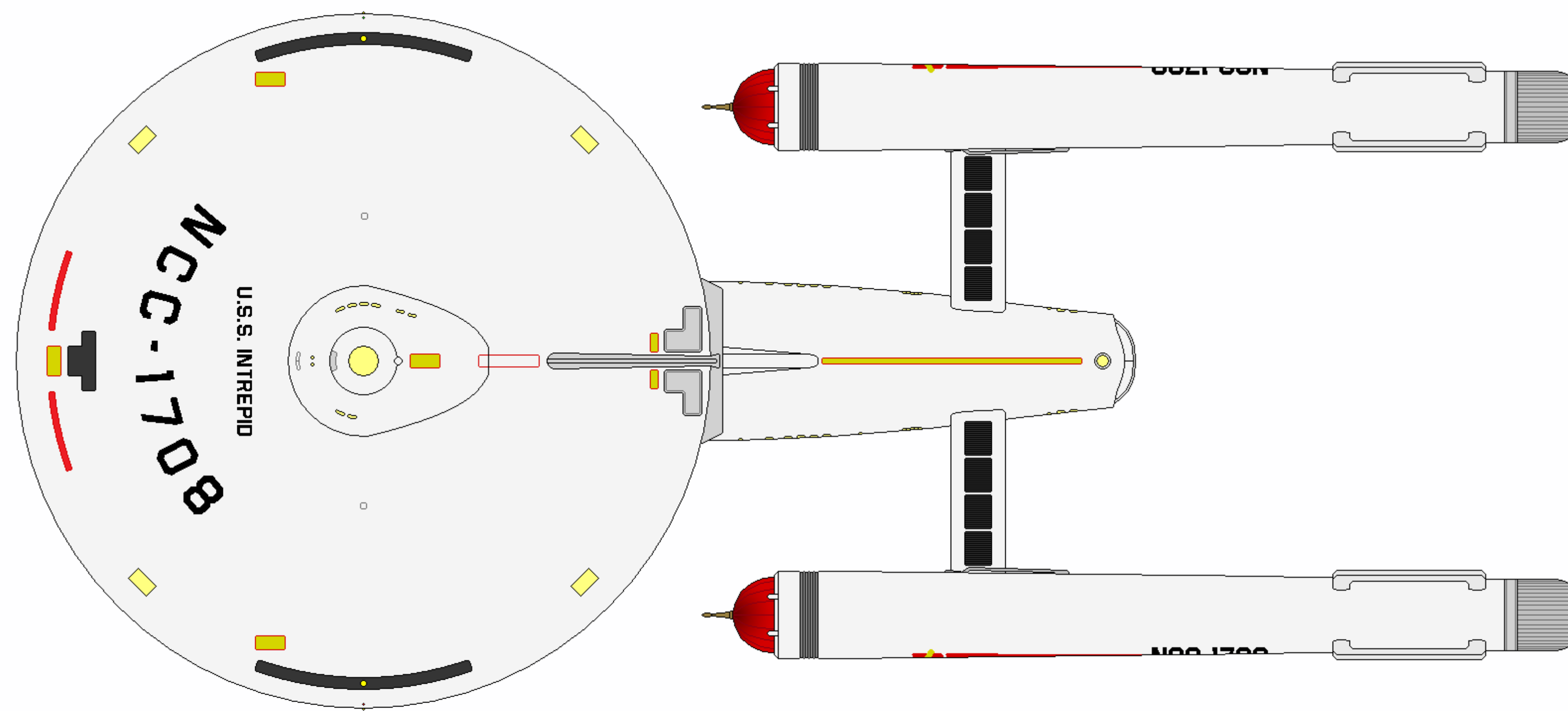



BONHOMME RICHARD SUBCLASS (TYPE 3)

CATEGORY:	HEAVY CRUISER		
OPERATIONAL:	2256 - 2264		
MODIFIED:	3 (CONSTITUTION FLIGHT II)		
DIMENSIONS:		TACTICAL:	
LENGTH:	288.6 M	- 4X TYPE VII PHASER EMITTERS	
BEAM:	127.1 M	- 2X TYPE VI PHASER EMITTERS	
HEIGHT:	72.6 M	- 2X MEDIUM TORPEDO TUBES	
MASS:	684,300 MT	(W/ 80 PHOTON TORPEDOES)	
		- 1-LAYER CONFORMAL FORCEFIELD	
PERFORMANCE:		- 1X PRIMARY NAVIGATIONAL DEFLECTOR	
CRUISE:	WARP 6 (OCU)	- 3X AUXILIARY NAVIGATIONAL DEFLECTORS	
MAX:	WARP 8 (OCU)		
ENDURANCE:	5 YEARS		
COMPLEMENT:		AUXILIARIES:	
OFFICERS:	50	- 1X HEAVY SHUTTLE	
ENLISTED:	293	- 2-4X LIGHT SHUTTLES	
		- 4X SHUTTLEPODS	
		- 4X WORK PODS	
		- VARIOUS SPECIAL ENVIRONMENT/TACTICAL CRAFT	

AUTHORIZED CONSTRUCTION

THE FOLLOWING SHIPS OF THE ABOVE CLASS WERE AUTHORIZED AS PART OF THE FEDERATION STAR FLEET BY FEDERATION COUNCIL APPROPRIATION. THE VESSELS WERE CONVERTED FROM THE CONSTITUTION FLIGHT II CONFIGURATION.

USS EXETER	NCC-1706	USS INTREPID	NCC-1708
USS HOOD	NCC-1707		

GENERAL INFORMATION

The flexibility of the relatively new phaser technology offered an enormous number of tactical choices, both offensive and defensive. A Star Fleet tactical review board chose to explore the potential of differing weapons loadouts on the Bonhomme Richard subclass for possible inclusion with future configurations of the Constitutions (and others). Of the ideas suggested, only two were approved for test runs on the Constitution Flight IIs being upgraded to the Bonhomme Richard standard. Three vessels were selected for each different loadout, with the ships sub-categorized as either Type 2 or Type 3 (the original production run and remaining upgraded vessels were referred to simply as Bonhomme Richards).

The Type 2 added two single phaser mounts (of the type VI variety) to the ventral side of the secondary hull, providing additional protective coverage to that critical portion of the ship's engineering superstructure. These were known as the amidship mounts. The Type 3 was a bit more radical: phaser VI emitters were added—as a twin bank—onto the dorsal saucer, further back from the standard position on the Constitution series, but located between decks 2 & 3, directly beneath the bridge. The Type VII phaser bank was separated, with one mount placed on either side of the bridge module, on the saucer proper. It was thought this would provide better coverage against attackers moving fore-to-aft or aft-to-fore, as well as bringing another full bank to bear at some point on the attacking exchange. However, only the amidship phasers went on to become a permanent fixture of future starship generations.

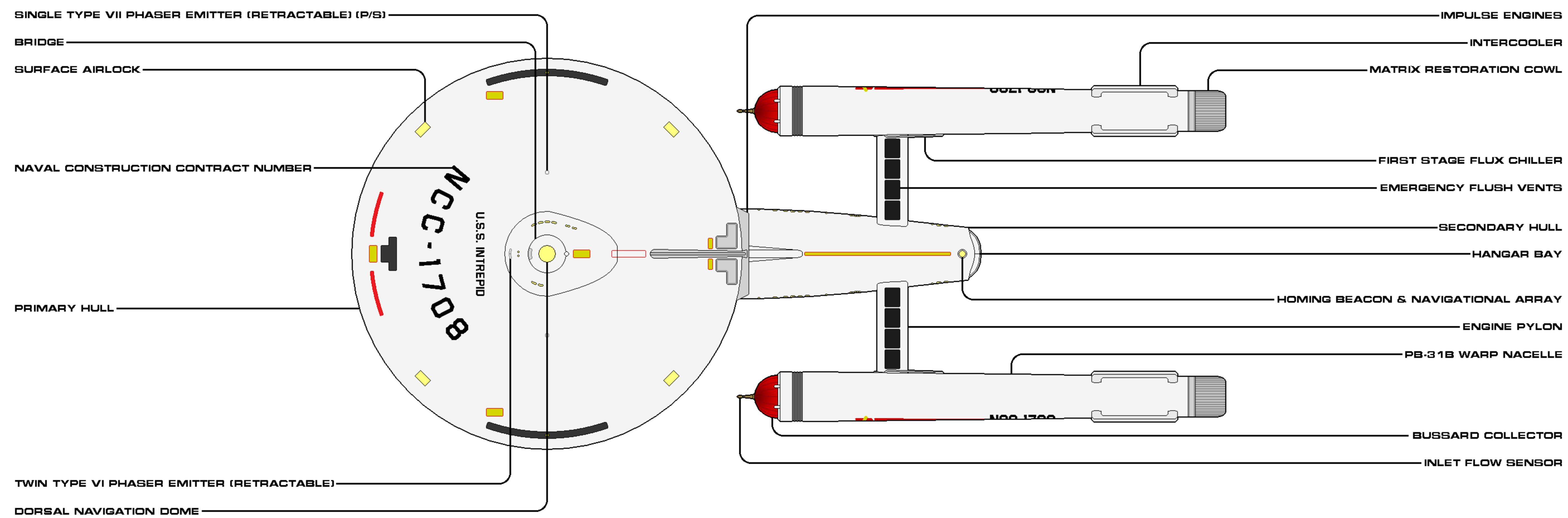
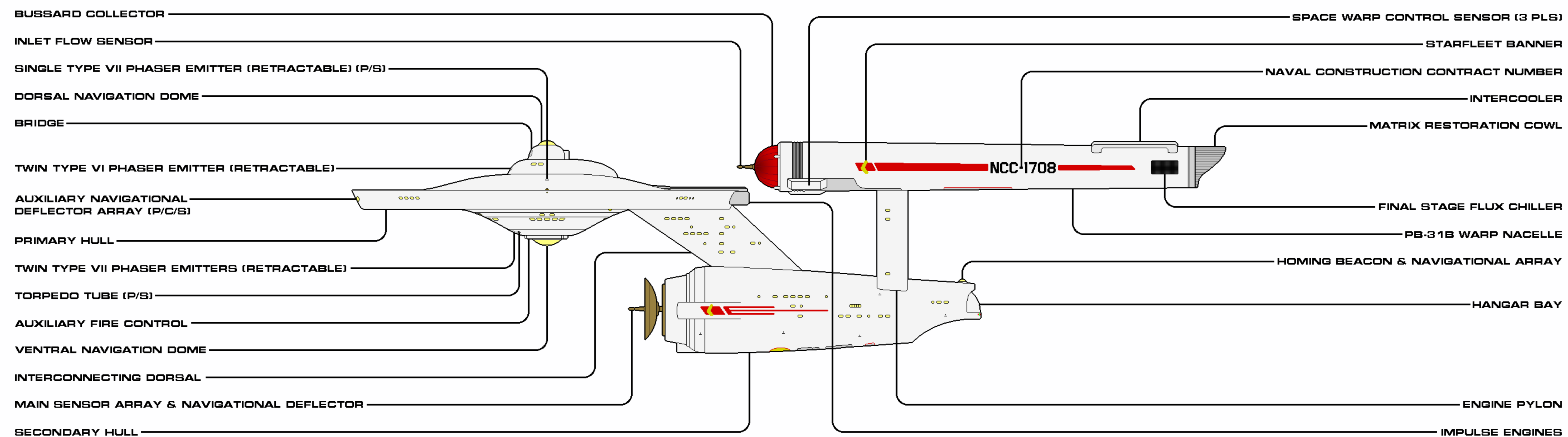

SHEET 1 OF 2

CLASS	CONSTITUTION	CATEGORY	HEAVY CRUISER
VARIANT	BR TYPE 3	CONSTRUCTED	2251
LENGTH	288.6 M	BEAM	121.1 M
HEIGHT	12.6 M	MASS	684,300 MT
OPERATIONAL	3	RELEASE DATE	2002.05

Authorized for release by Star Fleet Bureau of Starship Construction

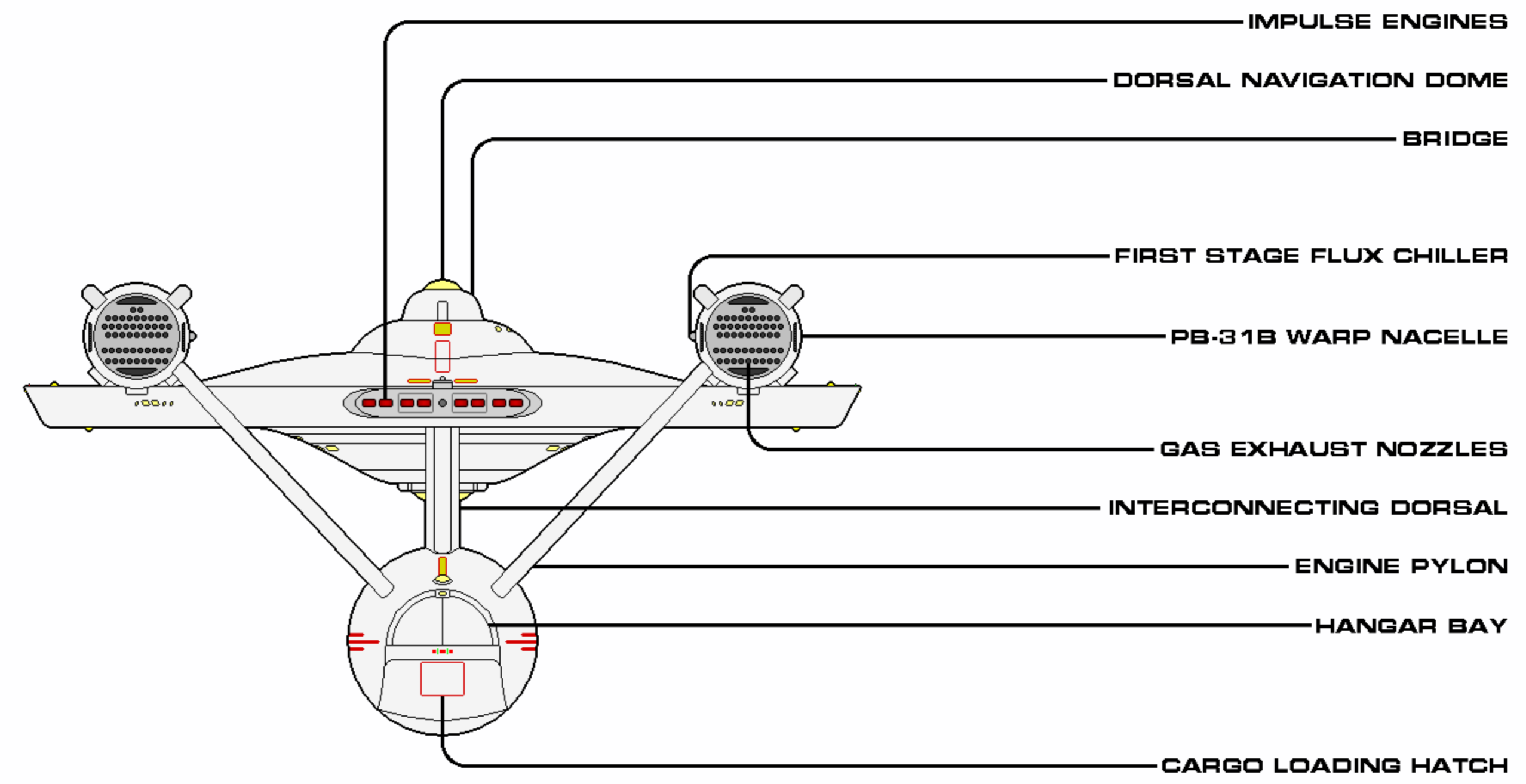
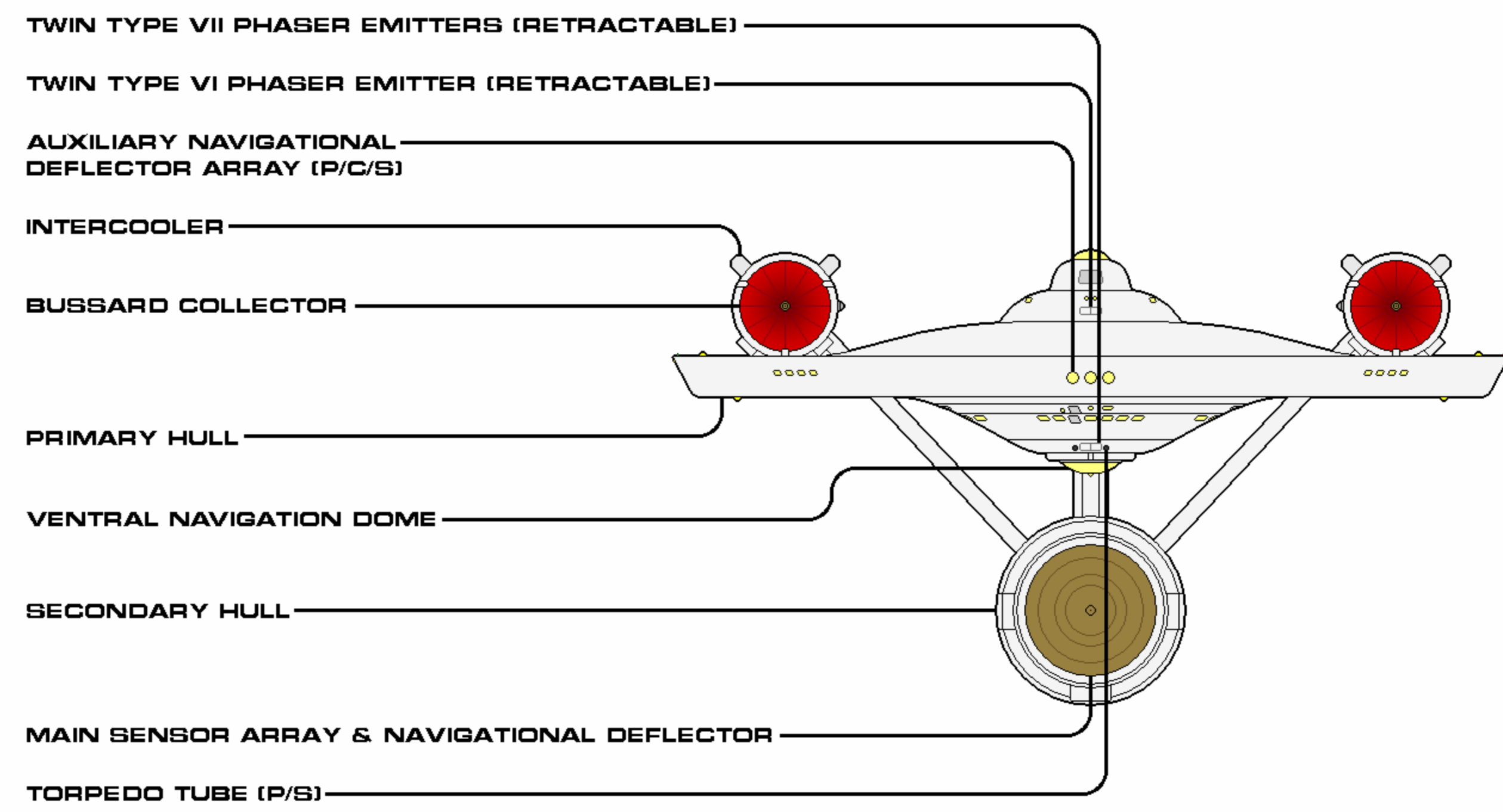
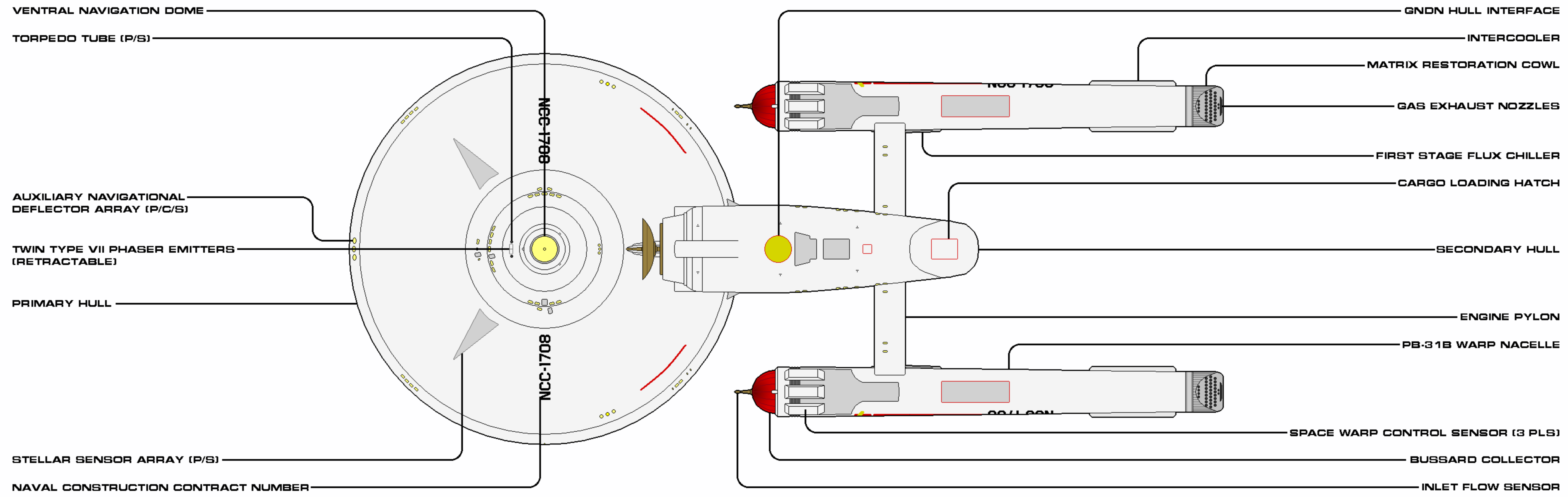

SHEET 2 OF 2

CLASS	CONSTITUTION	CATEGORY	HEAVY CRUISER
VARIANT BR TYPE	3	CONSTRUCTED	2251
LENGTH	208.6 M	BEAM	121.1 M
HEIGHT	12.6 M	MASS	604,300 MT
OPERATIONAL	3	RELEASE DATE	2002.05

Authorized for release by Star Fleet Bureau of Starship Construction

CONSTITUTION FLIGHT III

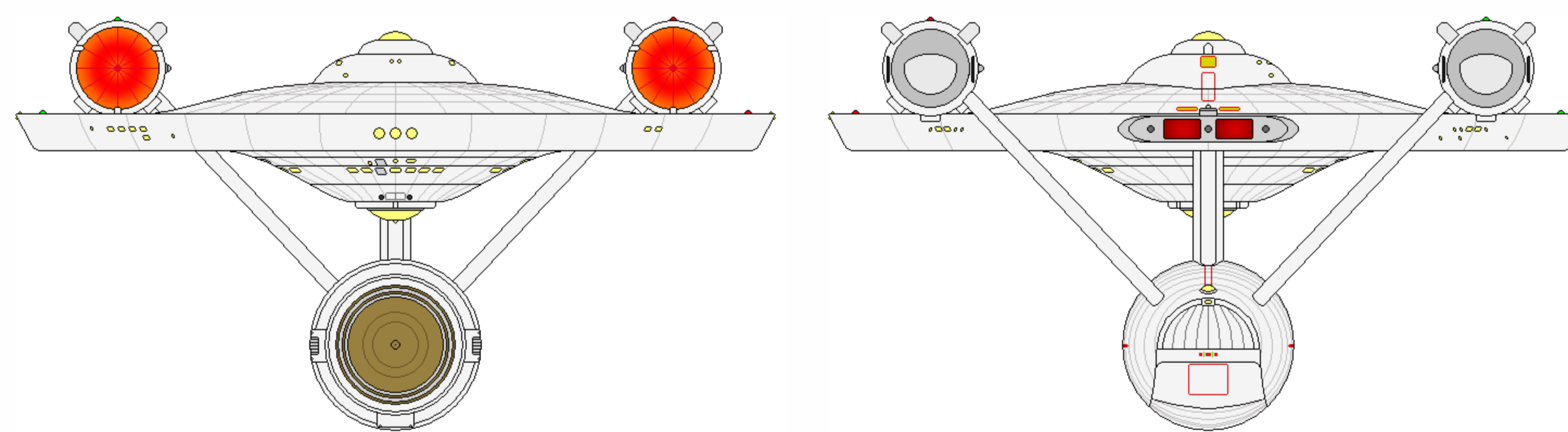
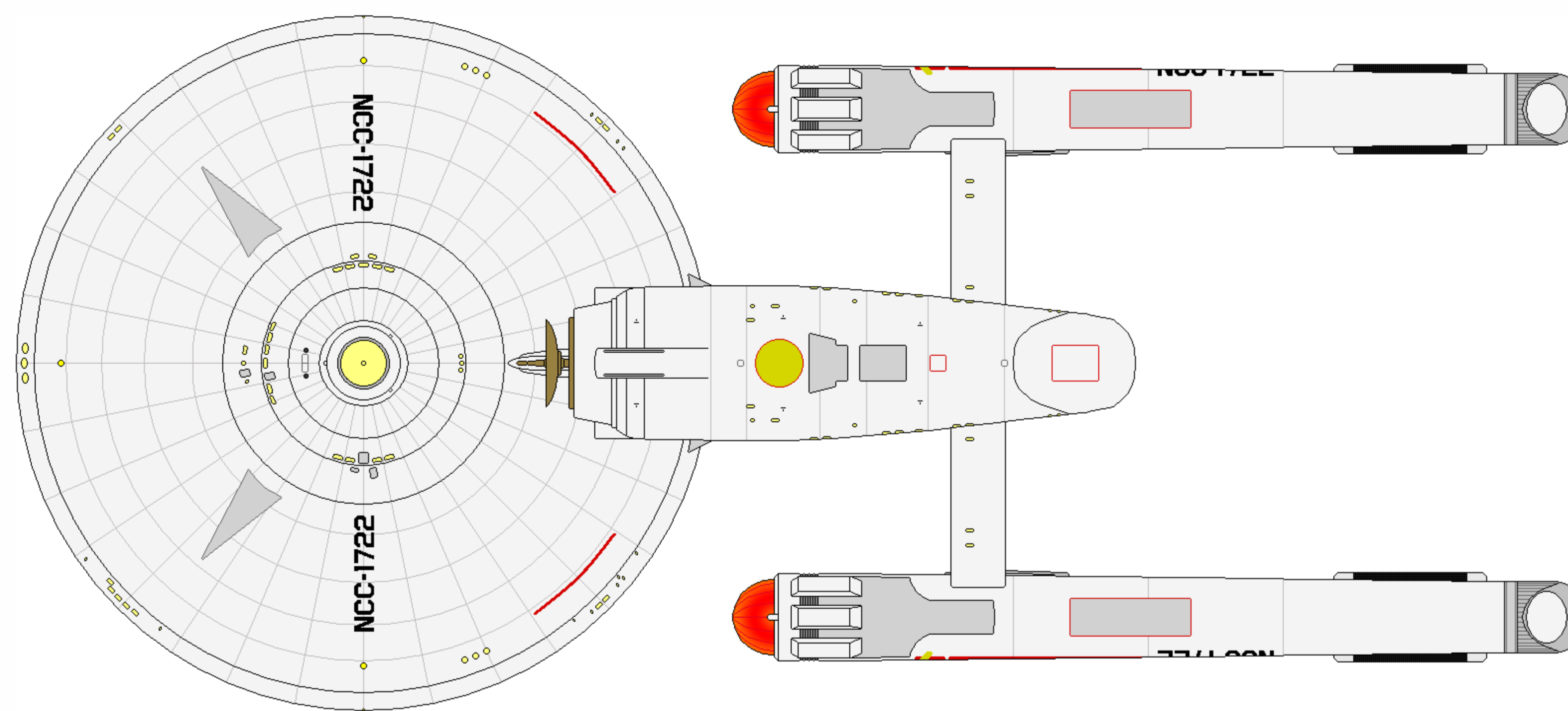
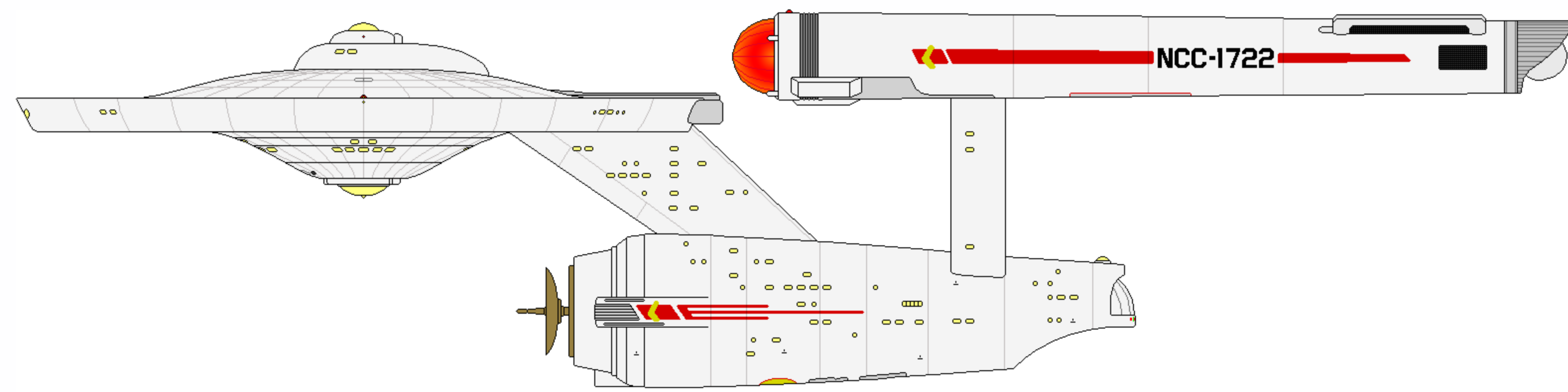
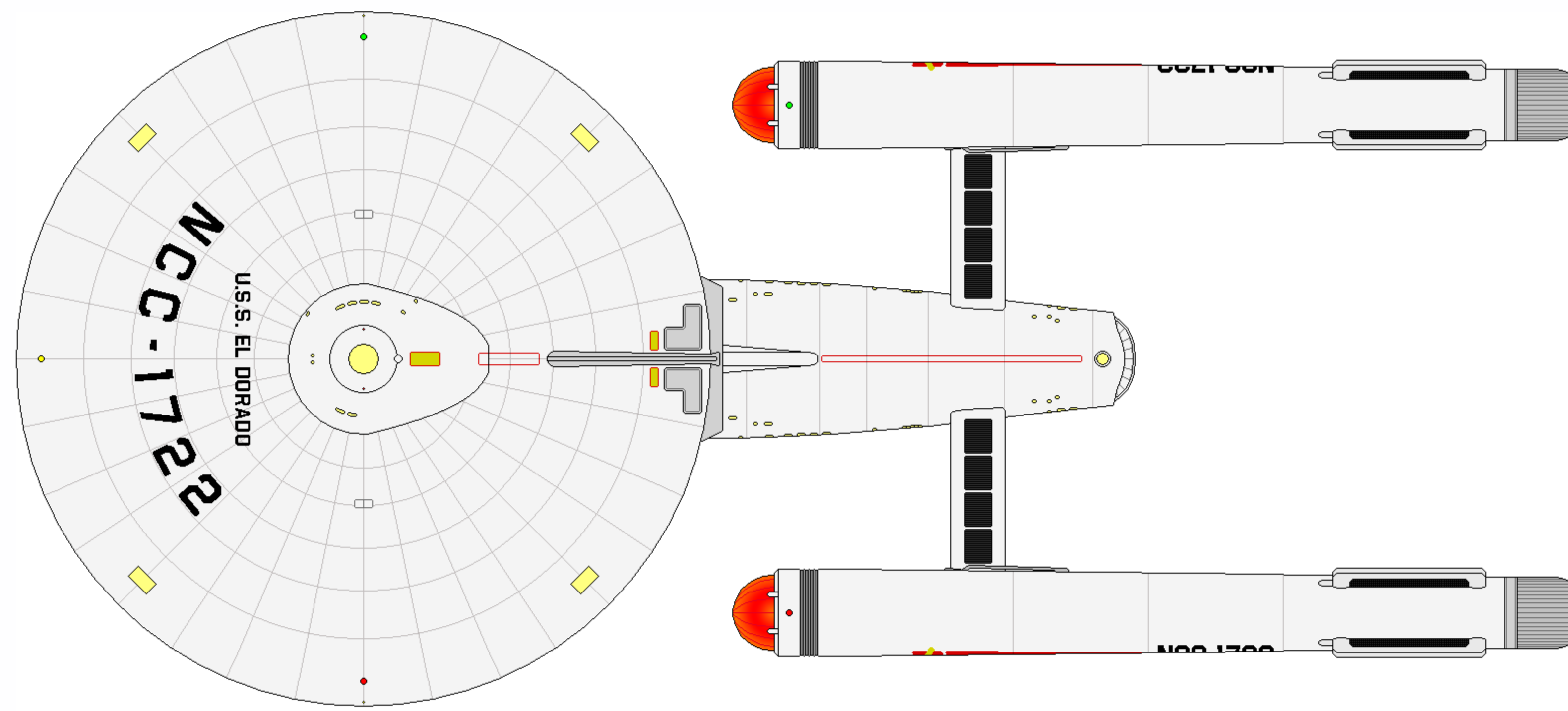



CONSTITUTION FLIGHT III

CATEGORY:	HEAVY CRUISER		
OPERATIONAL:	2260 - 2277		
MODIFIED:	28 (BONHOMME RICHARD SUBCLASS)		
DIMENSIONS:		TACTICAL:	
LENGTH:	288.6 M	- 6X TYPE VII PHASER EMITTERS	
BEAM:	127.1 M	- 2X TYPE VI PHASER EMITTERS	
HEIGHT:	72.6 M	- 2X MEDIUM TORPEDO TUBES	
MASS:	693,000 MT	(W/ 80 PHOTON TORPEDOES)	
		- 1-LAYER CONFORMAL FORCEFIELD	
PERFORMANCE:		- 1X PRIMARY NAVIGATIONAL DEFLECTOR	
CRUISE:	WARP 6 (OCU)	- 3X AUXILIARY NAVIGATIONAL DEFLECTORS	
MAX:	WARP 9 (OCU)		
ENDURANCE:	5 YEARS		
COMPLEMENT:		AUXILIARIES:	
OFFICERS:	43	- 1X HEAVY SHUTTLE	
ENLISTED:	387	- 2-4X LIGHT SHUTTLES	
		- 4X SHUTTLEPODS	
		- 4X WORK PODS	
		- VARIOUS SPECIAL ENVIRONMENT/TACTICAL CRAFT	

AUTHORIZED CONSTRUCTION

THE FOLLOWING SHIPS OF THE ABOVE CLASS WERE AUTHORIZED AS PART OF THE FEDERATION STAR FLEET BY FEDERATION COUNCIL APPROPRIATION. THE VESSELS WERE CONVERTED FROM THE BONHOMME RICHARD CONFIGURATIONS.

USS CONSTELLATION	NCC-1017	USS HORNET	NCC-1714
USS CONSTITUTION	NCC-1700	USS MERRIMAC	NCC-1715
USS ENTERPRISE	NCC-1701	USS ENDEAVOR	NCC-1716
USS FARRAGUT	NCC-1702	USS DEFIANCE	NCC-1717
USS LEXINGTON	NCC-1703	USS EXCELSIOR	NCC-1718
USS YORKTOWN	NCC-1704	USS EAGLE	NCC-1719
USS EXCALIBUR	NCC-1705	USS LAFAYETTE	NCC-1720
USS EXETER	NCC-1706	USS WASP	NCC-1721
USS HOOD	NCC-1707	USS EL DORADO	NCC-1722
USS INTREPID	NCC-1708	USS ARI	NCC-1723
USS KONGO	NCC-1710	USS SARATOGA	NCC-1724
USS POTEKIN	NCC-1711	USS TORI	NCC-1725
USS BONHOMME RICHARD	NCC-1712	USS KRIEGER	NCC-1726
USS MONITOR	NCC-1713	USS ESSEX	NCC-1727

GENERAL INFORMATION

The Constitution series of heavy cruisers existed in 4 different iterations, each succeeded by the next, over a period stretching from 2245—when USS Enterprise (NCC-1701) was unveiled—until 2265, when the Victory subclass, all newbuilds, arrived on the scene. The final upgrade configuration, that of the Constitution Flight III standard, served the longest as the predominant archetypical heavy cruiser with the most members, 28. The primary upgrade it received was the installation of PB-47 nacelles, which propelled it a full factor higher, to warp 9. However, there were several other significant and minor changes that served to unite the entire series under this configuration, such as the inclusion of the exact weapons loadout as tested with the Bonhomme Richards Type 2.

This configuration was also the one that took the heaviest losses, though that fact must be viewed through a lens of knowledge before judging the design. No vessels had been destroyed or listed as missing in action since the first, USS Valiant (NCC-1709), in 2247. However, in 2267, that safe period ended with the intentional sacrifice of the USS Constellation (NCC-1017), the grand-dame of the Constitution series, in order to stop a planet-destroying juggernaut. The following year was far more devastating, not only to the class but to Star Fleet itself: USS Excalibur (NCC-1705) was devastated by a bizarre computer malfunction during wargames, USS Intrepid (NCC-1708) lost to yet another leviathan, and USS Defiant (NCC-1764) and USS Rivoli (NCC-1765) were both lost while in (markedly different) missions with TacFleet. The last two were of the Victory subclass, so do not count against the Flight III's total registry. However, these high number of back-to-back losses contributed to the McLaren administration's perspective of a misguided exploration policy and the subsequent major cutbacks, as well as the resignation-in-protest of Fleet Admiral Heihachiro Nogura. Common-but incorrect-knowledge has only the USS Enterprise returning from the completed 5-years exploration program, when in actuality 23 experienced line vessels (7 from the original production run) were accepted for refit with the new linear warp nacelles. (USS Kongo suffered a crippling onboard explosion in 2277, precluding her own upgrade.)

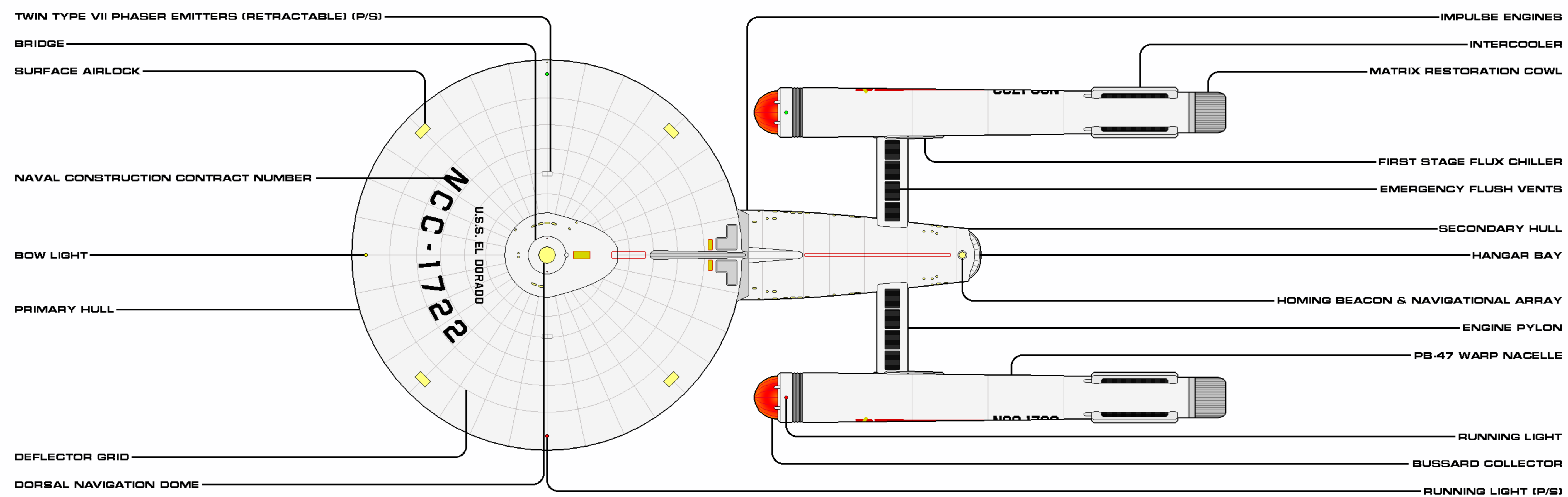
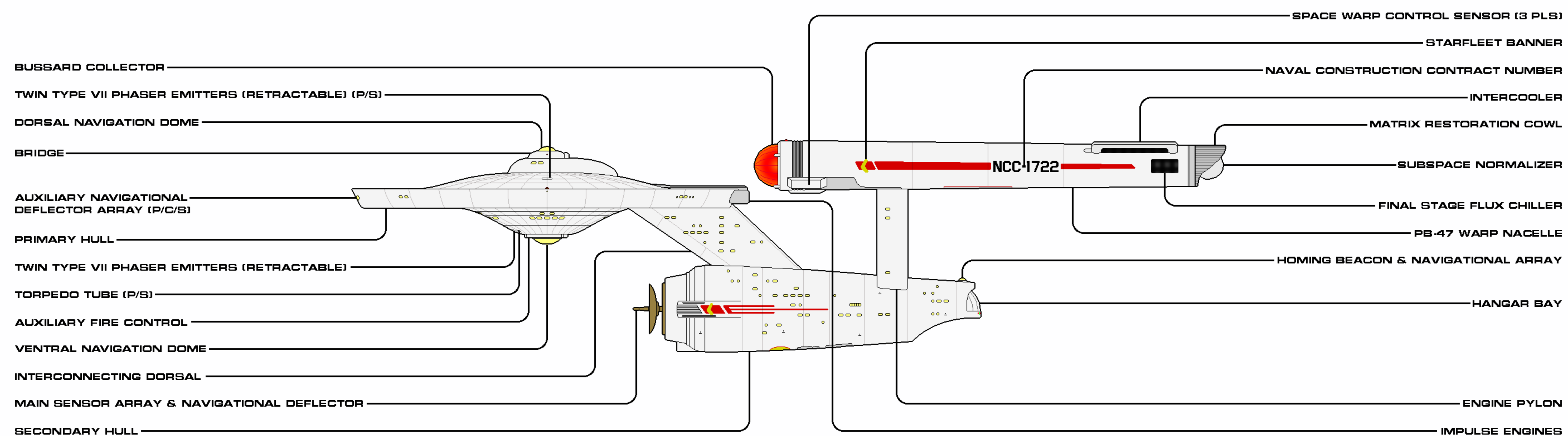

SHEET 1 OF 2

CLASS	CONSTITUTION	CATEGORY	HEAVY CRUISER
VARIANT	CONSTITUTION FLT III	MODIFIED	2251
LENGTH	288.6 M	BEAM	121.1 M
HEIGHT	12.6 M	MASS	633,000 MT
OPERATIONAL	28	RELEASE DATE	2002.05

Authorized for release by Star Fleet Bureau of Starship Construction

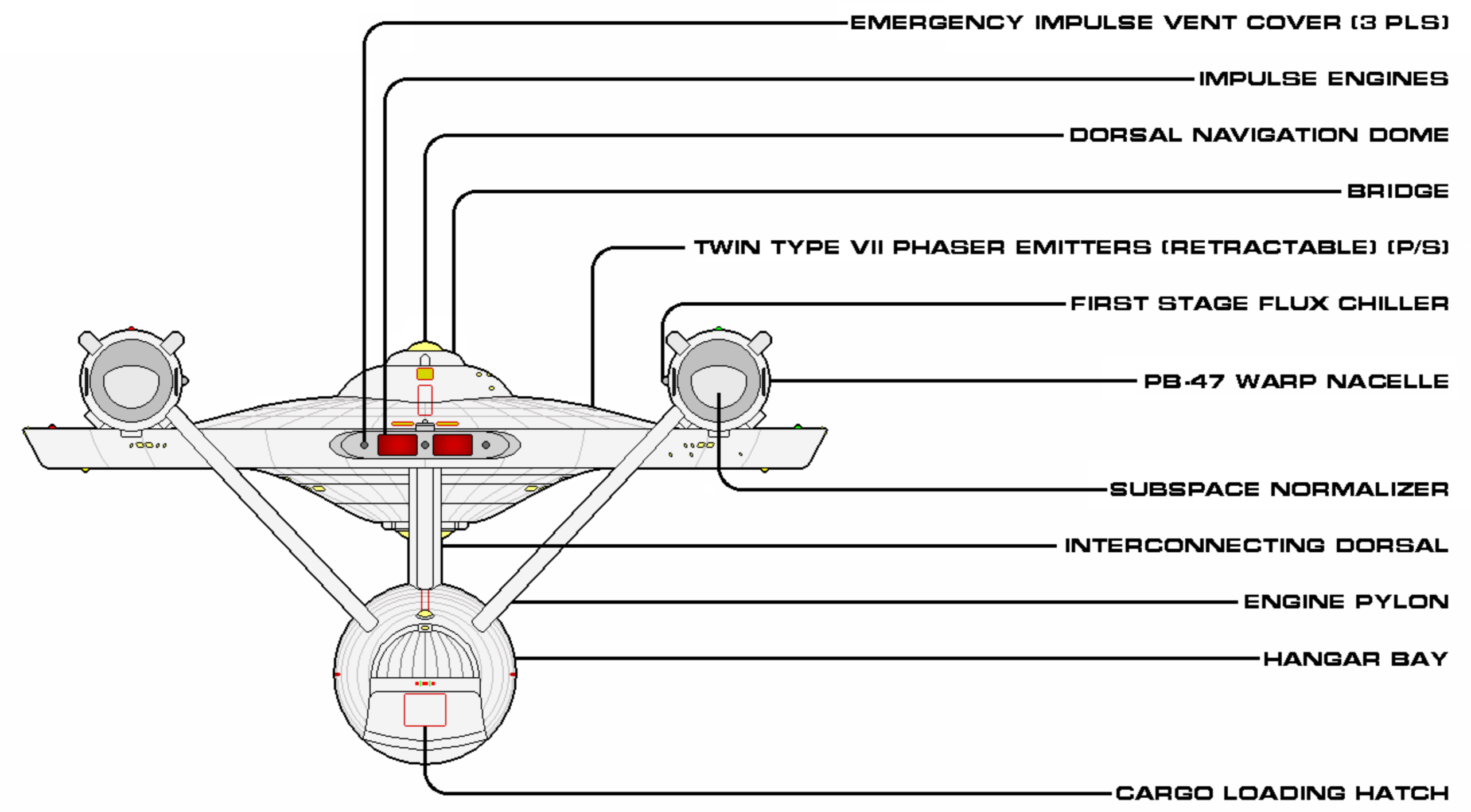
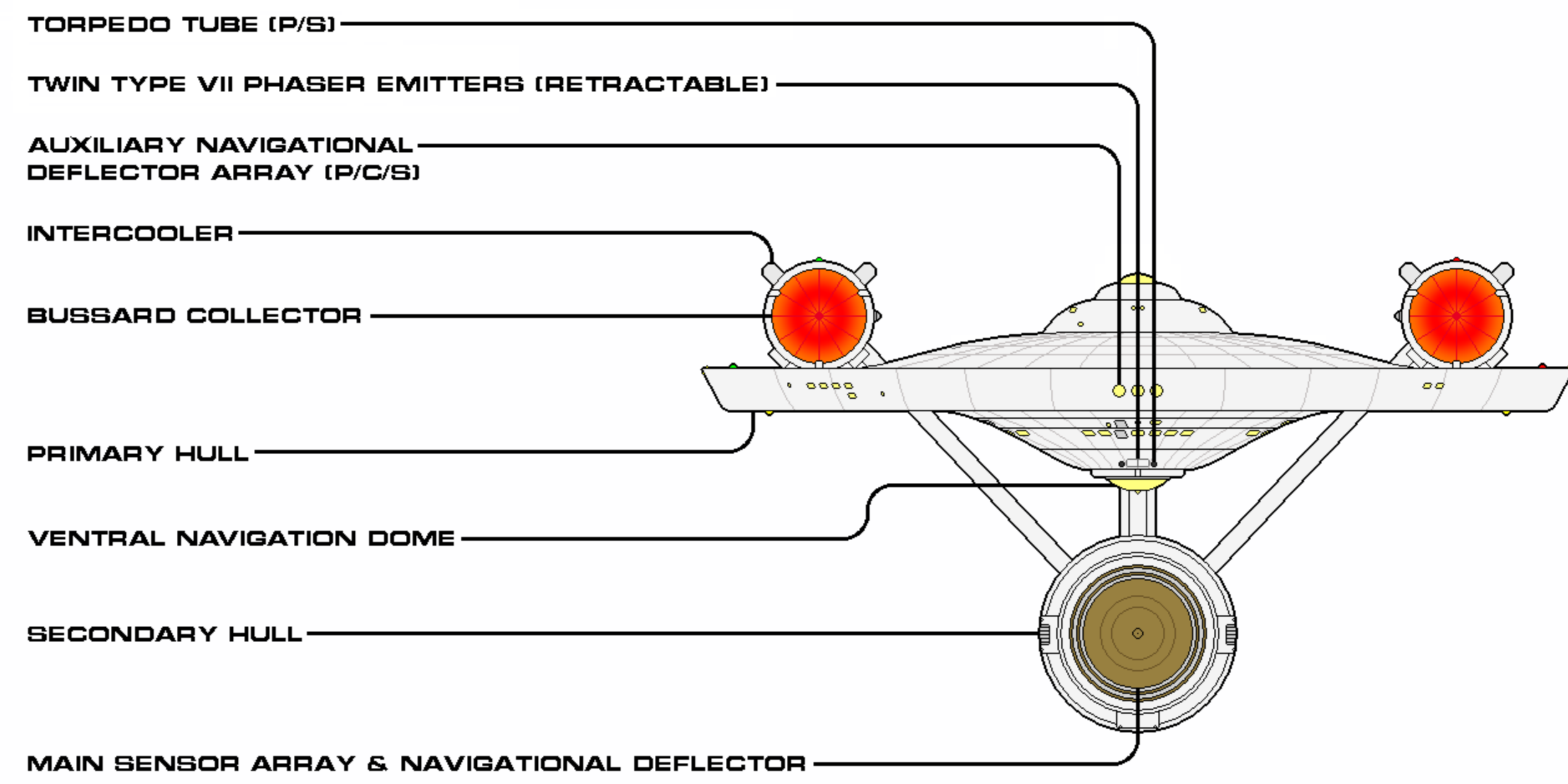
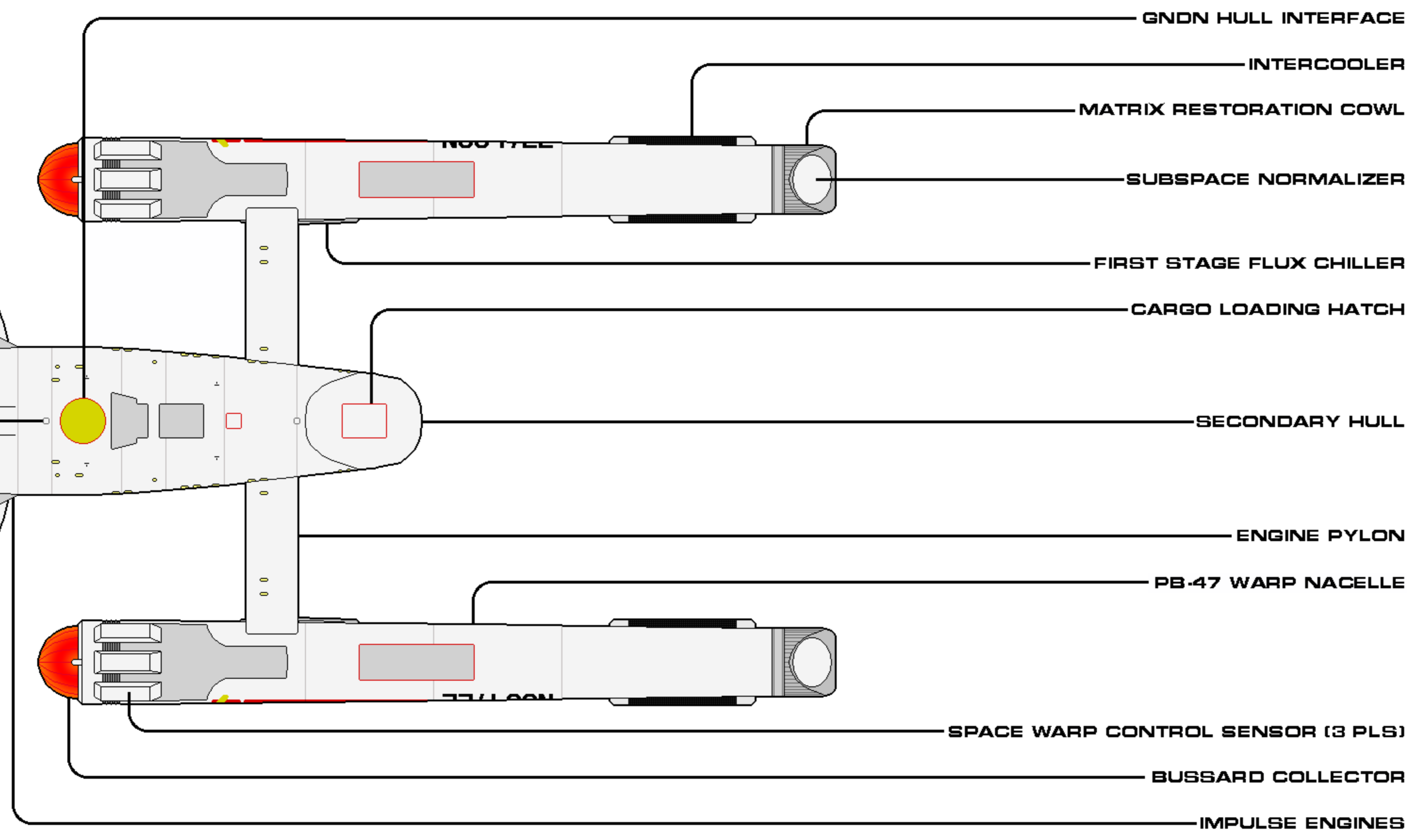
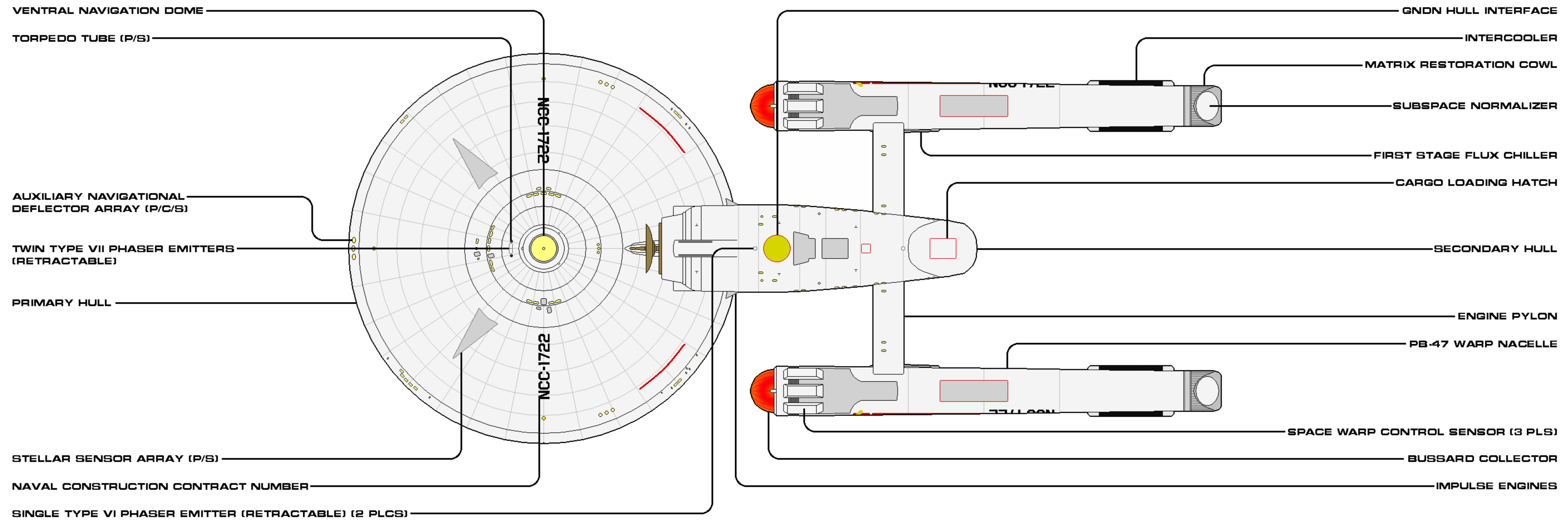

SHEET 2 OF 2

CLASS	CONSTITUTION	CATEGORY	HEAVY CRUISER
VARIANT	CONSTITUTION FLT III	MODIFIED	2251
LENGTH	288.6 M	BEAM	121.1 M
HEIGHT	12.6 M	MASS	693,000 MT
OPERATIONAL	28	RELEASE DATE	2002.05

Authorized for release by Star Fleet Bureau of Starship Construction

VICTORY SUBCLASS

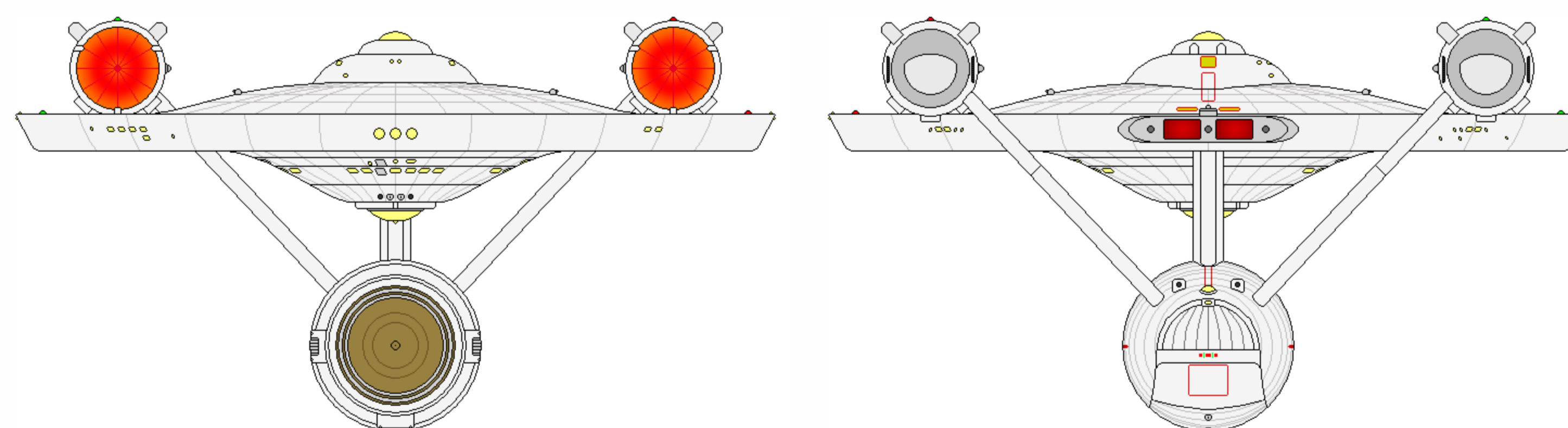
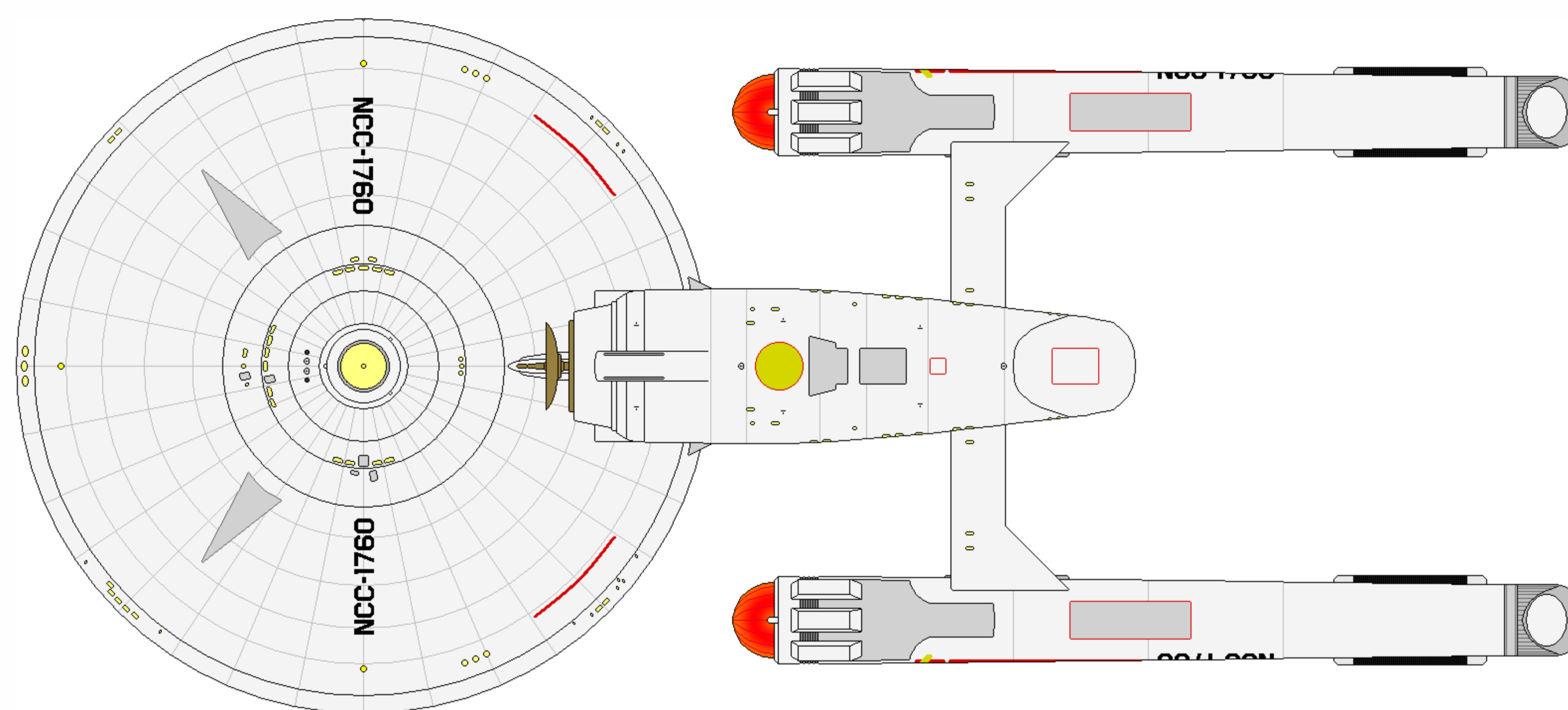
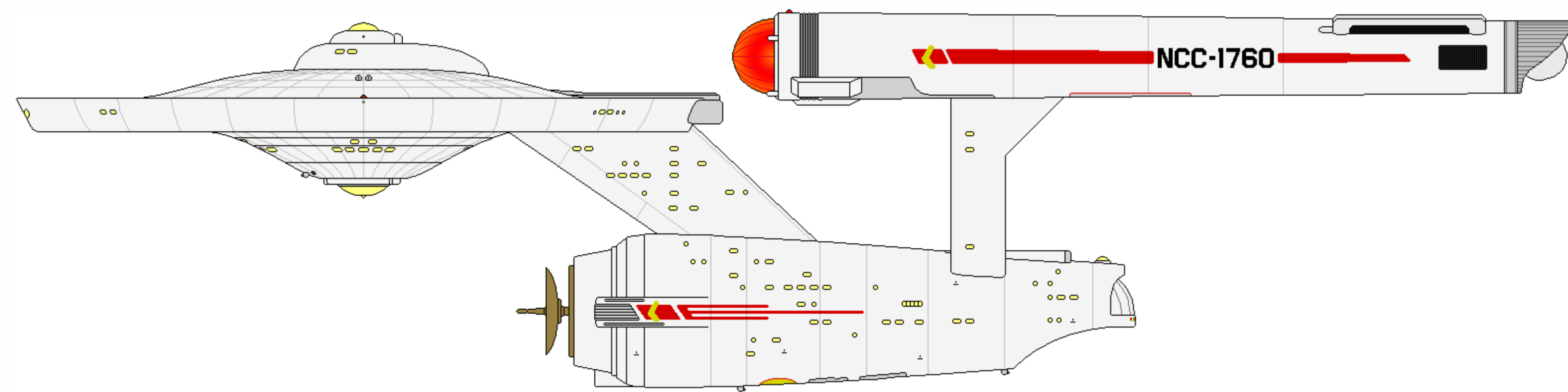
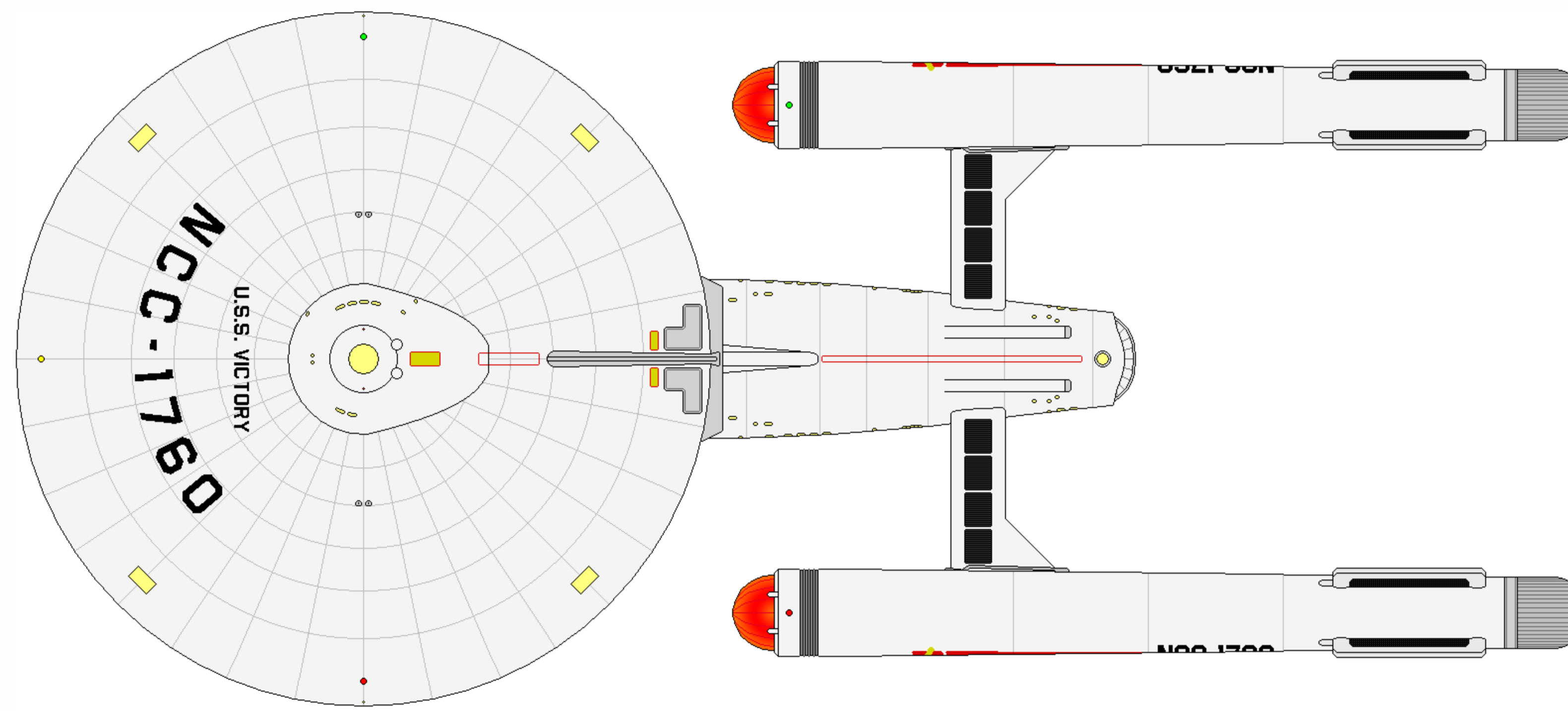



VICTORY SUBCLASS

CATEGORY: HEAVY CRUISER
OPERATIONAL: 2265 - 2279
CONSTRUCTED: 6

DIMENSIONS:
LENGTH: 288.6 M
BEAM: 127.1 M
HEIGHT: 72.6 M
MASS: 697,500 MT

PERFORMANCE:
CRUISE: WARP 6 (OCU)
MAX: WARP 9 (OCU)
ENDURANCE: 5 YEARS

COMPLEMENT:
OFFICERS: 43
ENLISTED: 387

TACTICAL:
- 6X TYPE VII PHASER EMITTERS
- 2X TYPE VI PHASER EMITTERS
- 4X MEDIUM TORPEDO TUBES
(W/ 150 PHOTON TORPEDOES)
- 1-LAYER CONFORMAL FORCEFIELD
- 1X PRIMARY NAVIGATIONAL DEFLECTOR
- 3X AUXILIARY NAVIGATIONAL DEFLECTORS

AUXILIARIES:
- 1X HEAVY SHUTTLE
- 2-4X LIGHT SHUTTLES
- 4X SHUTTLEPODS
- 4X WORK PODS
- VARIOUS SPECIAL ENVIRONMENT/TACTICAL CRAFT

AUTHORIZED CONSTRUCTION

THE FOLLOWING SHIPS OF THE ABOVE CLASS WERE AUTHORIZED AS PART OF THE FEDERATION STAR FLEET BY FEDERATION COUNCIL APPROPRIATION.

USS VICTORY	NCC-1760	USS TEMIR	NCC-1763
USS OOMARU	NCC-1761	USS DEFIANT	NCC-1764
USS YAAN	NCC-1762	USS RIVOLI	NCC-1765

GENERAL INFORMATION

In 2261, the Constitution series had reached its fourth incarnation with the Flight III configuration and operational reviews were reporting top marks along almost every criteria point. TacFleet, the starship administrative chain of command that oversees the utilization of assets for the defense of the United Federation of Planets, took note of the versatility of the class, as well as the successful conclusions of those limited number of tactical missions completed by heavy cruisers temporarily assigned to the Echelon III Star Fleet component. Because TacFleet was generally tasked with missions of a timelier and combat-oriented nature, there often wasn't a Constitution class vessel close enough or otherwise available to address situations that were sometimes well-aligned with those ships' capabilities. TacFleet successfully lobbied for six newbuilds based upon the Flight III configuration to ensure dedicated access to these ships.

The most obvious modification from the exploration-minded Constitutions was the addition of two aft-firing medium torpedo tubes installed upon the dorsal side of the secondary hull, to discourage pursuit (in those scenarios where retreat was the proper course of action). Cargo spaces peripherally located to these launchers were re-designed as munition bunkers, providing an additional 70 photon torpedo capacity. The two single phaser mounts that originated on the Bonhomme Richard Type 2 were particularly applicable with the type of classified missions in which TacFleet vessels are often engaged, as some opponents made use of smaller and more numerous vessels in swarming attacks. Accordingly, the tactical suites of the Victories were enhanced and tertiary relays insured that more phaser banks could be charged and fired, and provided additional rerouting options in the event of combat damage. Lastly, the retraction gear for the directed energy weapons was removed, with each mount affixed directly on the surface of the hull: diplomacy and discretion were not tools TacFleet called upon and the response time was now limited to charging the phasers.

The vessels would serve through 2279 in what was termed ambiguously as "detached duty" until relieved by later tactical classes, and were not themselves refitted to a more modern standard. Two vessels were lost: USS Defiant (NCC-1764) went missing into an interdimensional rift in the direction of Tholian space, while the USS Rivoli (NCC-1765) was lost in a reported combat situation that has not yet been declassified (or even acknowledged).

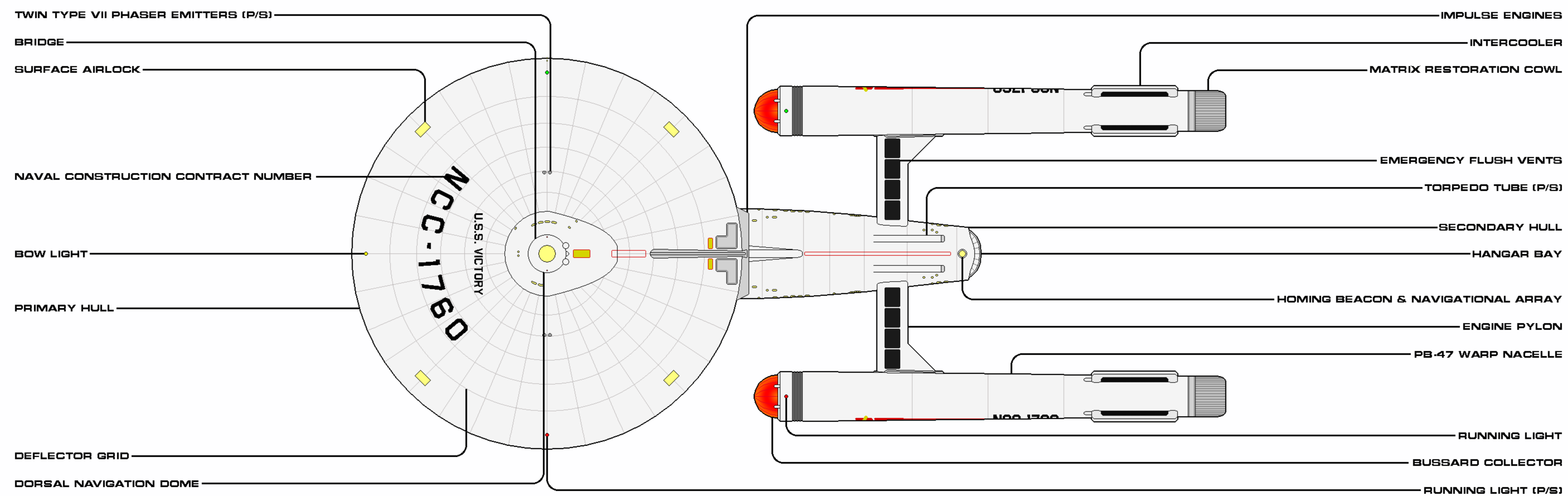
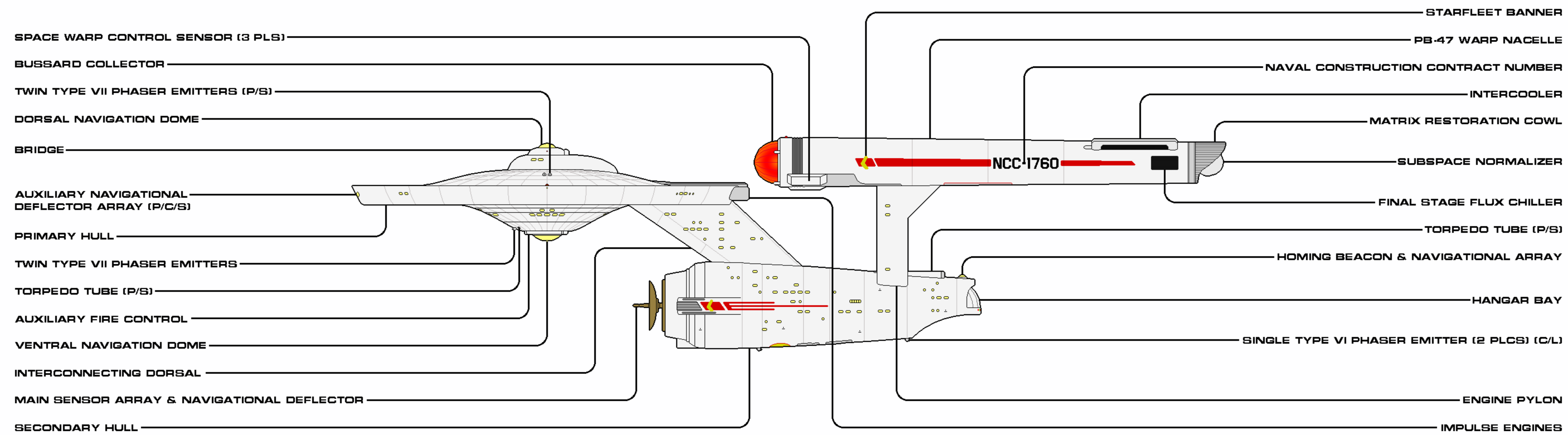

SHEET 1 OF 2

CLASS	CONSTITUTION	CATEGORY	HEAVY CRUISER
VARIANT	VICTORY	CONSTRUCTED	2265
LENGTH	288.6 M	BEAM	121.1 M
HEIGHT	12.6 M	MASS	697,500 MT
OPERATIONAL	28 6	RELEASE DATE	2002.05

Authorized for release by Star Fleet Bureau of Starship Construction

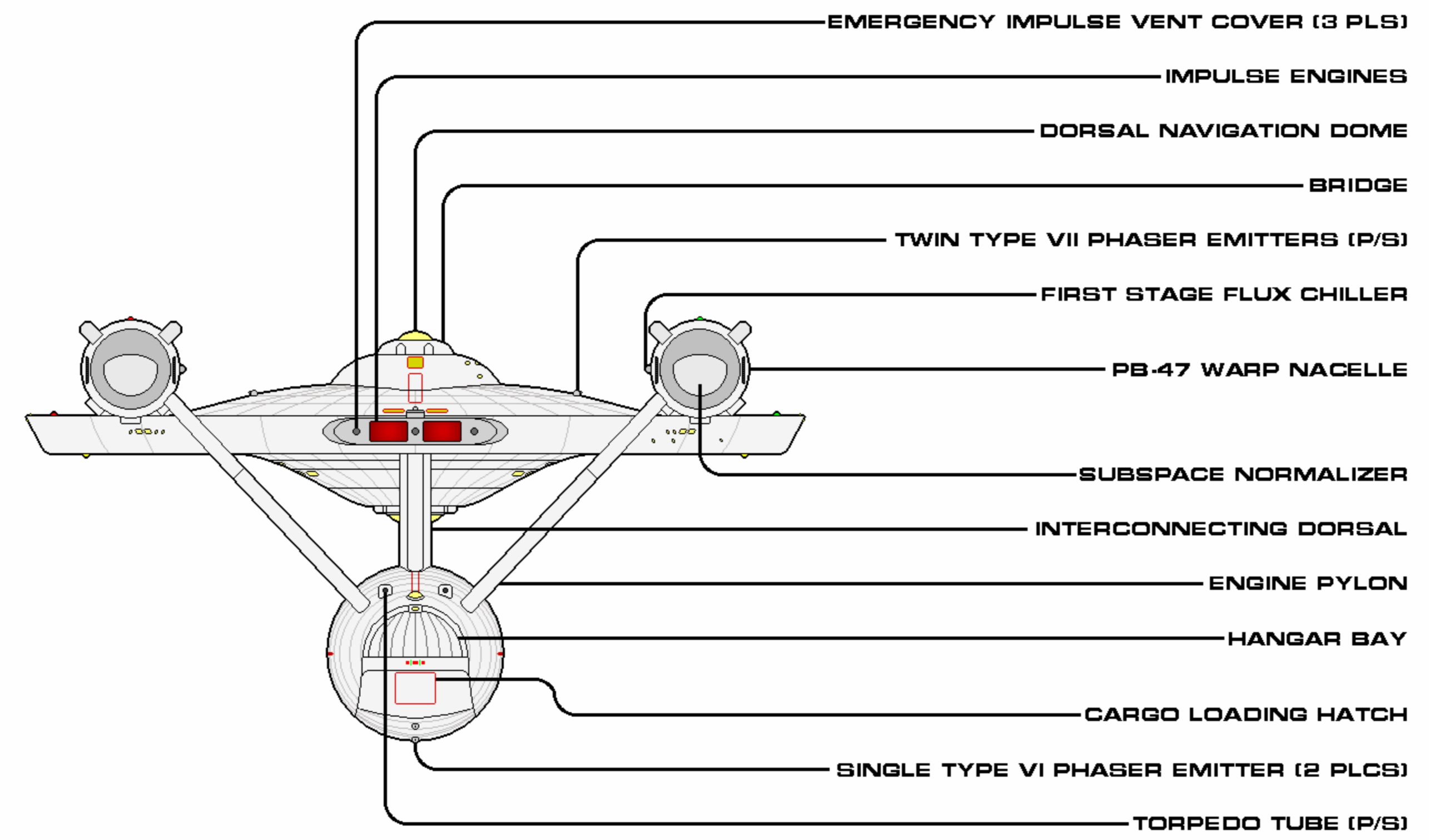
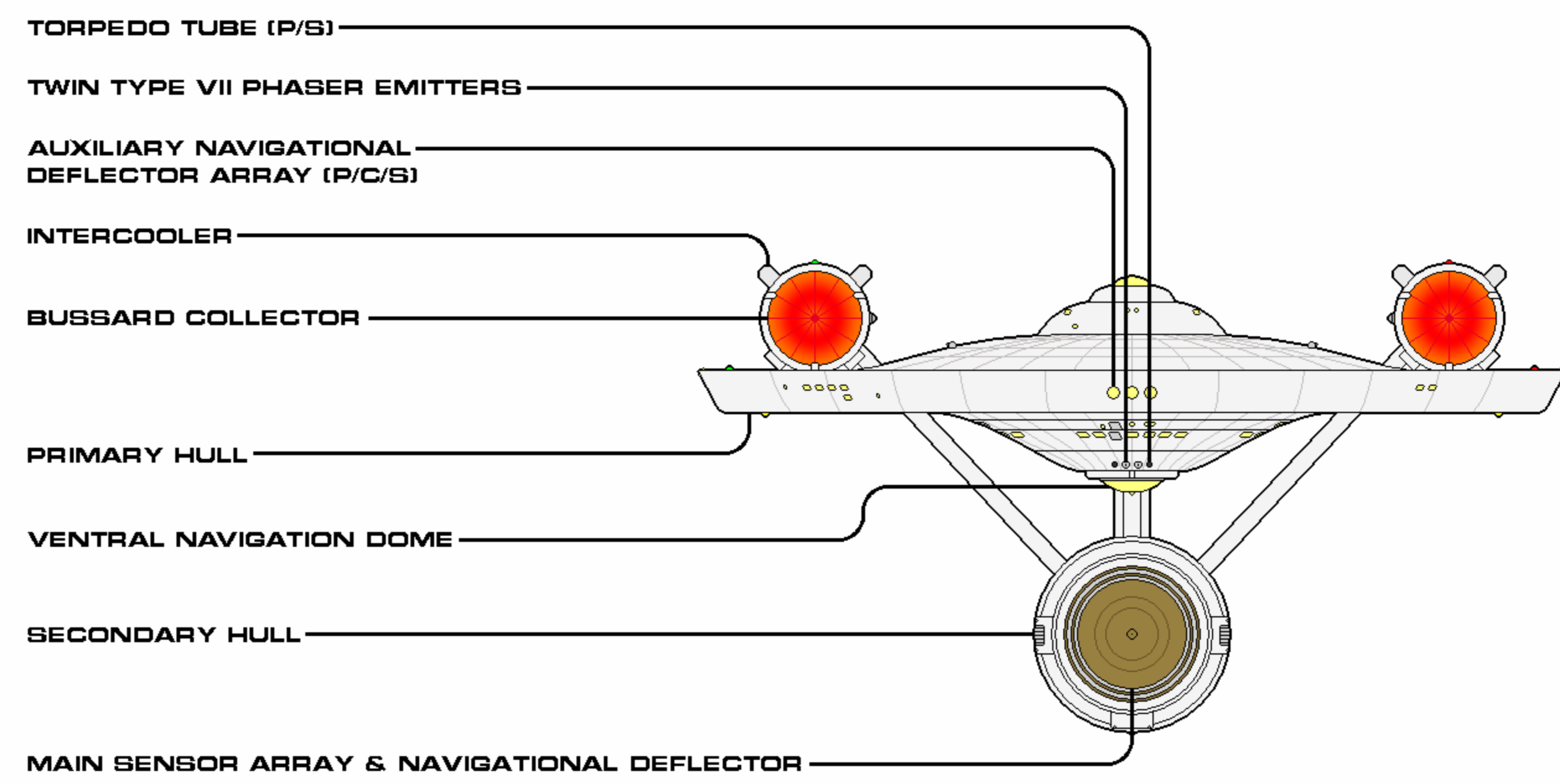
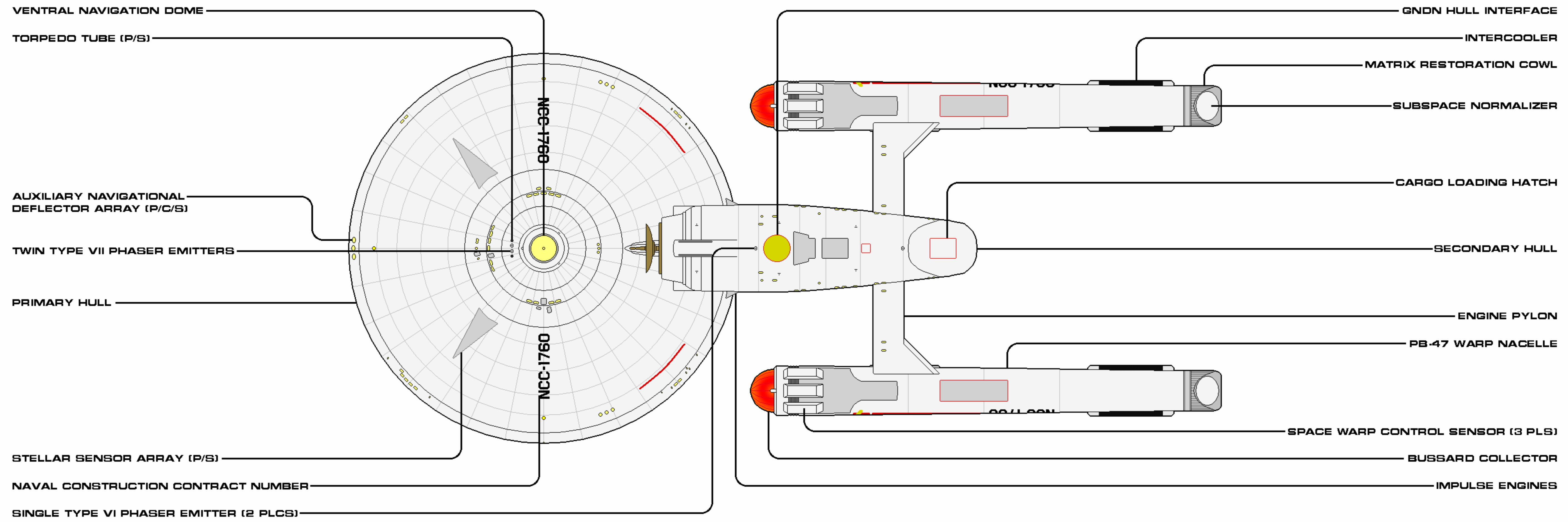

SHEET 2 OF 2

CLASS CONSTITUTION	CATEGORY HEAVY CRUISER
VARIANT VICTORY	CONSTRUCTED 2265
LENGTH 208.6 M	BEAM 121.1 M
HEIGHT 12.6 M	MASS 691500 MT
OPERATIONAL 28 6	RELEASE DATE 2002.05

Authorized for release by Star Fleet Bureau of Starship Construction

USS REPUBLIC (ACADEMY TRAINER)

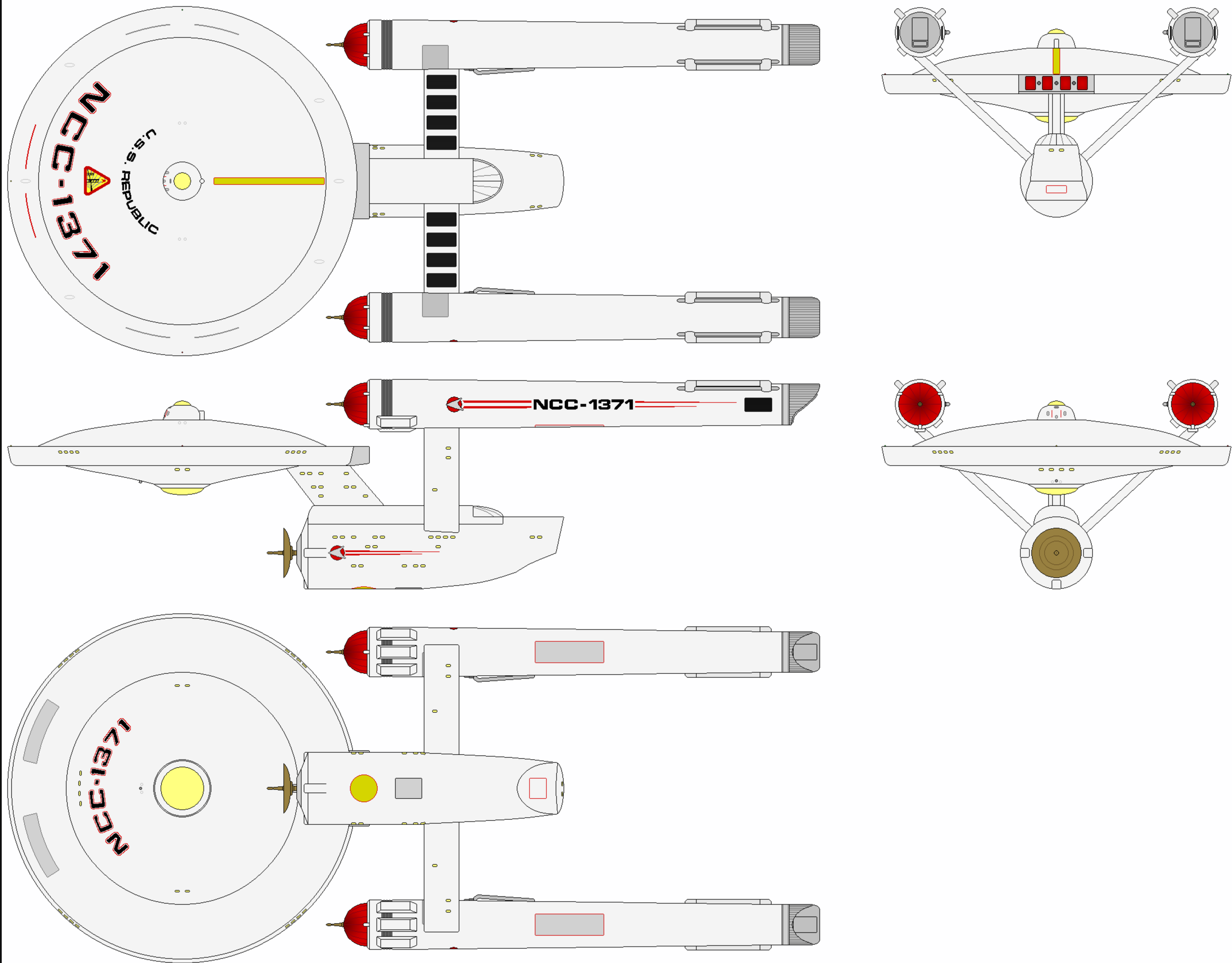

CATEGORY: HEAVY CRUISER
OPERATIONAL: 2286 - 2289
MODIFIED: 1 (OPERATIONAL STANDARD)

DIMENSIONS:
LENGTH: 265.2 M
BEAM: 114.1 M
HEIGHT: 68.3 M
MASS: 693,650 MT

TACTICAL:
- 1X 4.0 GW LASER EMITTER
- 1-LAYER CONFORMAL FORCEFIELD
- 1X PRIMARY NAVIGATIONAL DEFLECTOR

PERFORMANCE:
CRUISE: WARP 6 (OCU)
MAX: WARP 8 (OCU)
ENDURANCE: N/A

COMPLEMENT:
OFFICERS: 31
ENLISTED: 177
CADETS: 222

AUXILIARIES:
- 2X LIGHT SHUTTLES
- 2X SHUTTLEPODS
- 1X WORK POD



USS REPUBLIC (ACADEMY TRAINER) AUTHORIZED CONSTRUCTION

THE FOLLOWING SHIPS OF THE ABOVE CLASS WERE AUTHORIZED AS PART OF THE FEDERATION STAR FLEET BY FEDERATION COUNCIL APPROPRIATION. THE VESSEL WITH REGISTRY 1371 WAS CONVERTED FROM THE PREVIOUS OPERATIONAL CONFIGURATION.

USS REPUBLIC NCC-1371

GENERAL INFORMATION

USS Republic (NCC-1371) was an old ship, but not a well-traveled one, when she was de-commissioned in 2257. She had been originally commissioned in 2222 as an Archon heavy cruiser, a subclass of the Horizon series, when she suffered a terrible conflagration in her forward bow's internal spaces during acceptance trials. Star Fleet had considered putting her back in the yards for repair, but she seemed the best overall candidate for Chiokis' experiments in designing a new heavy cruiser. When she was de-commissioned for the project by the end of that same year, it was the former USS Constellation (NCC-1017, Advance subclass heavy cruiser) that was designated as the primary testbed. One rationale was Republic, having almost no warp stress (compared to Constellation's 17 years of service) would be a "cleaner" vessel in which to establish the modifications necessary for the other Horizon vessels that were intended to be refitted to the new standard. Constellation would test the various articles of new equipment, such as nacelles, deflectors, and—very importantly—the warp core.

Republic was stripped of all salvageable equipment—to be repurposed for ready spares—and left bow- and nacelle-less in a mothballed status for almost 15 years. Late in 2237, she was towed back into the shipyard and rebuilt, retaining only the structure of her secondary hull as the basis of the new supership. As detailed in the earlier article on her prototype status, she performed what were initially perceived by her design and engineering teams to be the new class' flight tests, maintaining warp 8 for considerable lengths of time without any indications of nacelle or core stresses.

However, it was the Constitution (NX-1700), built to very similar standards (but with a Siva class saucer) that showed the weaknesses that were only apparent with the unique stress of sustained combat over three serious battles. Automatic damage control procedures needed considerable refinement and the weapon systems' power routing required additional redundancies. The Republic standard had done well in battle, but there was now verifiable room for improvement. These new standards affected both internal and external spaces, most visibly with the shuttlebay, and were eventually unveiled on USS Enterprise (NCC-1701), the production prototype for what would become known as the Constitution heavy cruiser class.

Instead of being refitted again to the production standard, Project Starship manager Robert April directed the Republic teams to bring her up to simplified operational standards in an example of the new class, making her fully active as soon as possible. Because of the introduction of so many technological advances, especially with the warp core and the maneuverability it afforded the vessels, he wanted a ship set aside to train the new hand-selected crews for the entire class. His Project Starship teams provided the re-commissioning crew in 2245, which performed defensive and first responder missions in the vicinity of the core worlds until 2248. From then until 2257, she was a platform for future Constitution class crews (and for the newer Flight II and Bonhomme Richard variants). By the latter part of the Fifties, there were enough experienced crews to allow direct assignment to these power horses of the fleet. It was decided USS Republic would be mothballed, for the cost to bring her up to the present operational standards was too great. Despite barely 14 years with warp experience, the ship was now 35 years old.

She was called again to service in 2285, when Star Fleet Academy's training vessel, USS Enterprise, was lost to enemy action in the Mutara sector. Without a ready and prepared vessel for the training and education role, it was decided to re-commission USS Republic. Because of the limited time frame to get her operational again and provide Academy cadets the necessary space hours for their graduation, she was not equipped with modern weaponry. Instead, all combat exercises would be computer simulated, with the one ceremonial exception of an original 4.0-gigawatt laser emitter that was moved laterally to the centerline, embedded in the location of the original photon torpedo launcher. The Academy logo was emblazoned on her dorsal hull and school shuttle pilots made it a matter of course that the cadets' first beauty passes of the ship was one of that visage, as they made their arrival approaches.

While she served for only four years as the Academy's training vessel, before being relieved by a series of far more modern starships, USS Republic (known affectionately and humorously as "the Pub") was often spoken of fondly by members of the seven classes that got underway with her.

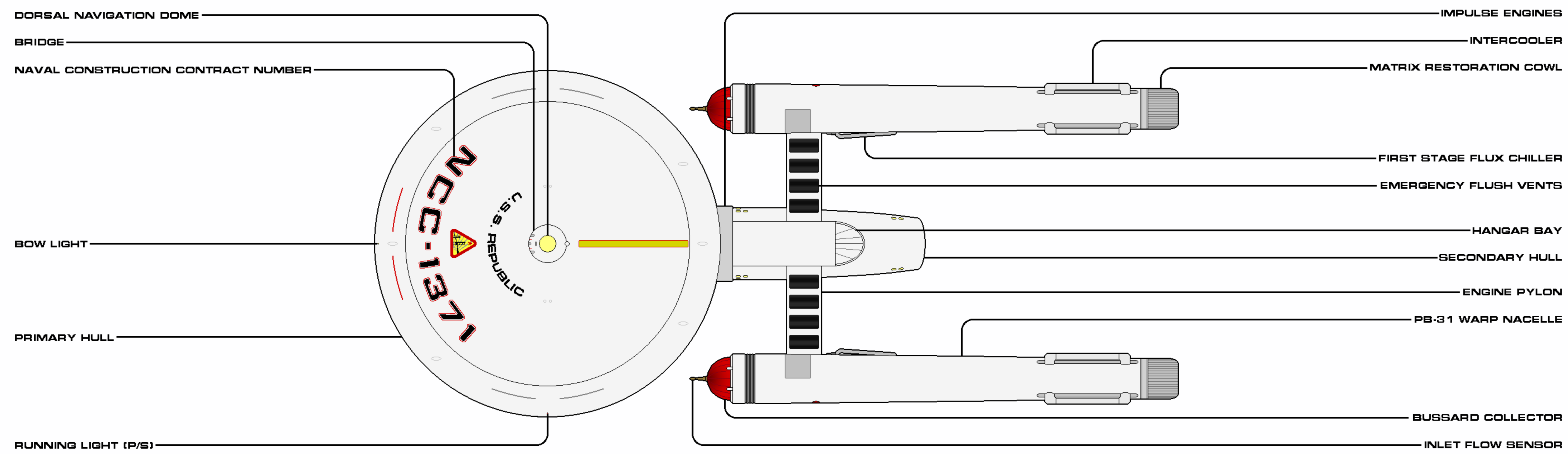
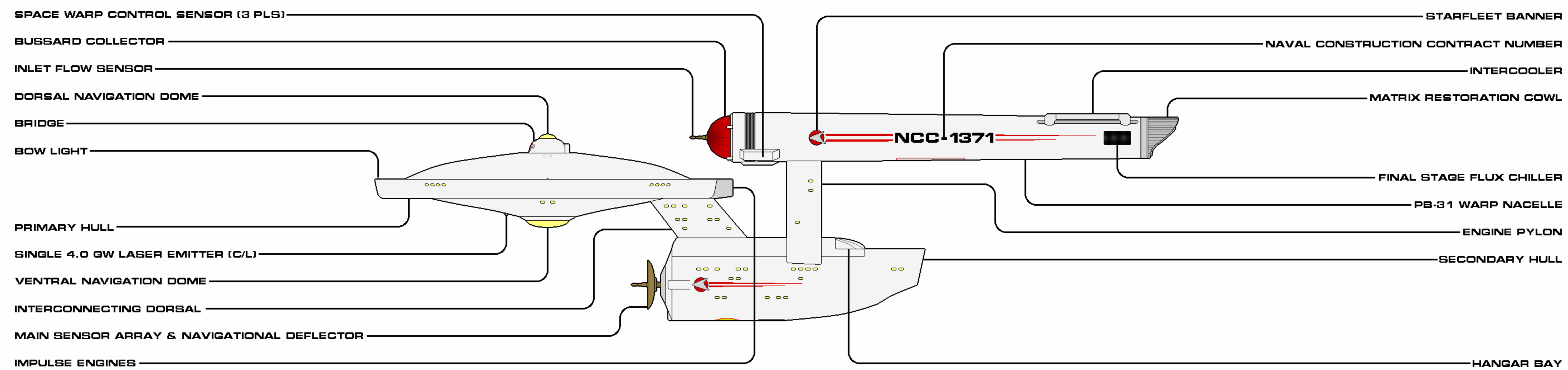

SHEET 1 OF 2	
CLASS REPUBLIC	CATEGORY HEAVY CRUISER
VARIANT TRAINING SHIP	MODIFIED 2286
LENGTH 265.2 M	BEAM 114.1 M
HEIGHT 68.3 M	MASS 633,650 MT
OPERATIONAL 1	RELEASE DATE 2001.30

Authorized for release by Star Fleet Bureau of Starship Construction

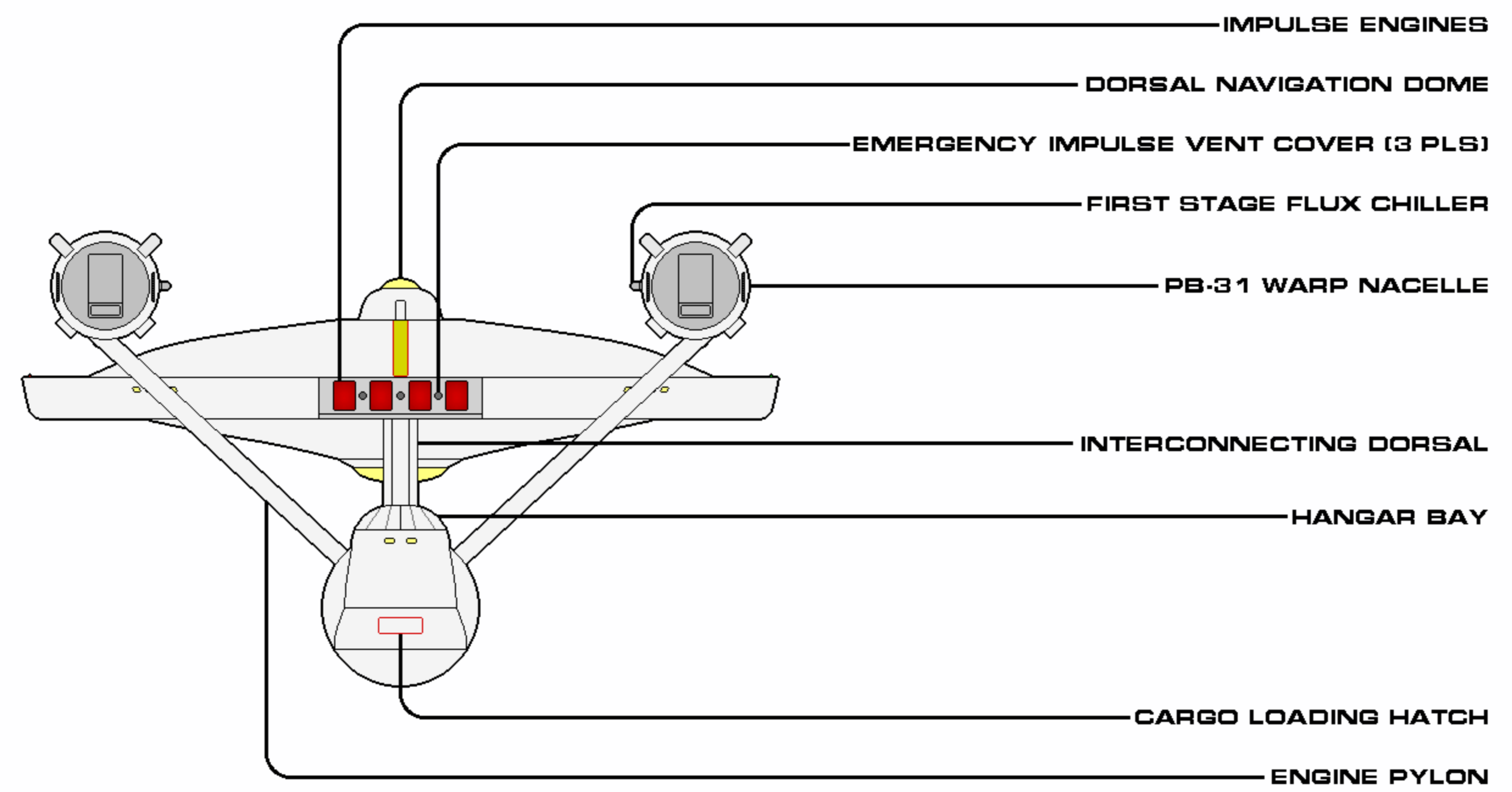
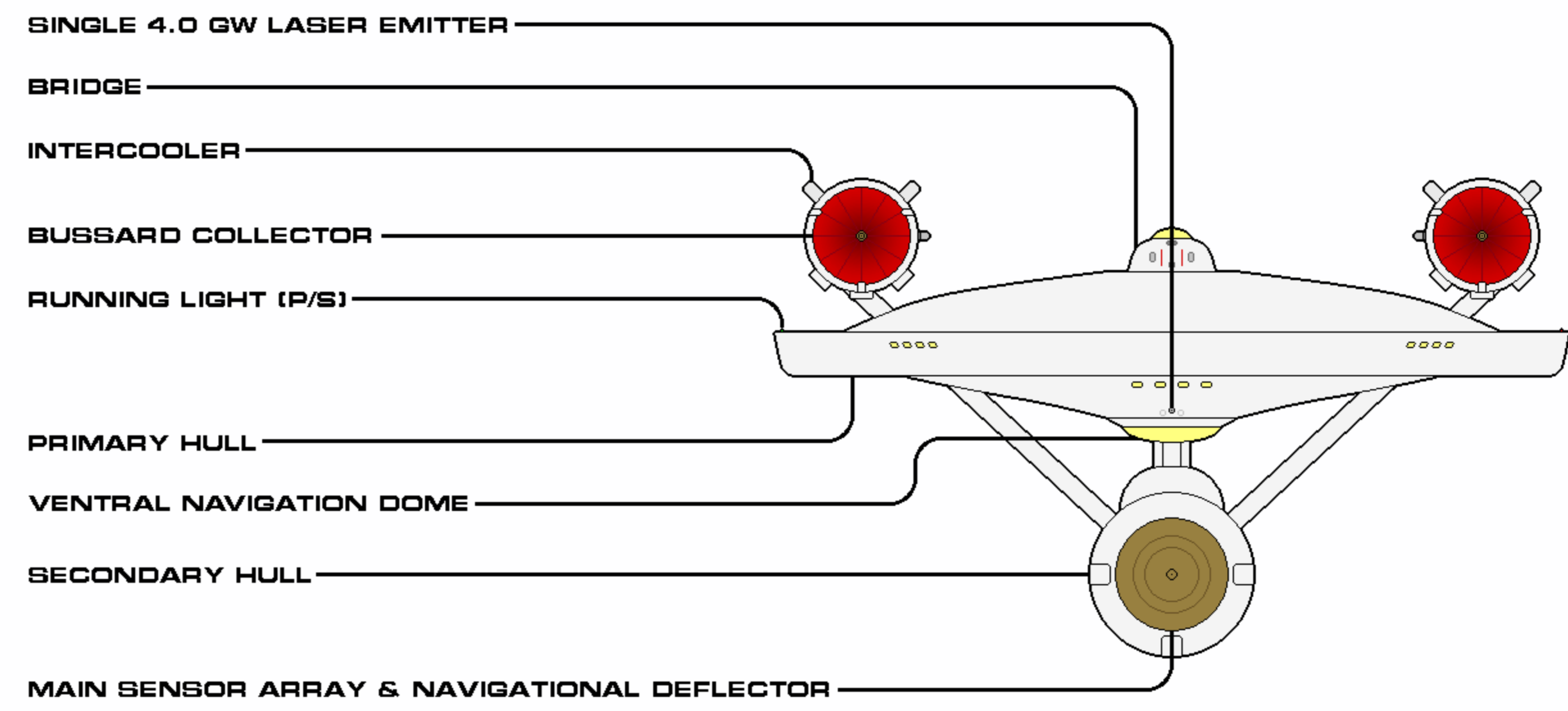
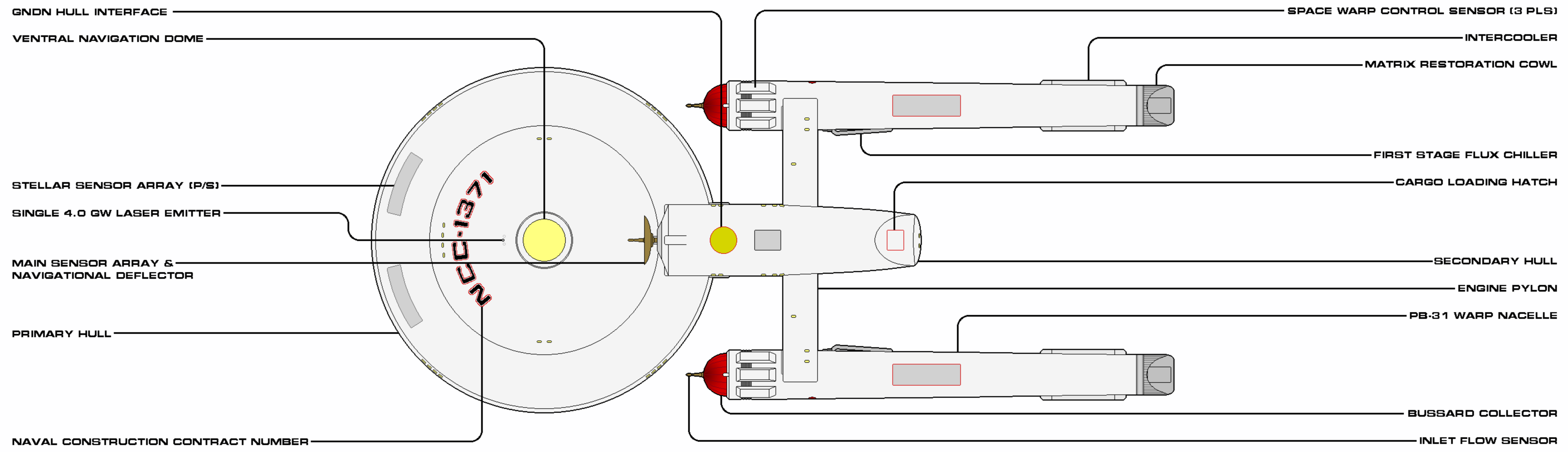

SHEET 2 OF 2

CLASS	REPUBLIC	CATEGORY	HEAVY CRUISER
VARIANT	TRAINING SHIP	MODIFIED	2286
LENGTH	288.2 M	BEAM	114.1 M
HEIGHT	68.3 M	MASS	693,650 MT
OPERATIONAL	1	RELEASE DATE	2001.30

Authorized for release by Star Fleet Bureau of Starship Construction



CLASS TIMELINE

2210

The trailing sensors of USS Siding Springs (NCC-1356, Lowell scout) intercept the signals of a high velocity probe passing through the galactic plane at an estimated speed of warp 430.

The basis for a new type of heavy cruiser with significant warp performance improvements is suggested by several classified studies.

2218

The final recorded attempt of piracy on a Watt class fleet tanker/transport occurs, and is foiled. Seventy-eight attempts have now been made (all failed), though four Watts are lost by this year to technical failure, two to natural phenomena, and one to a game of Go.

The real events of the 2215 Allegany incident are revealed and the backlash does significant damage to public relations.

The "Klingon Offensive" takes place.

A multi-ship conflict occurs between the Klingon Empire and Star Fleet. Light cruiser USS Ranger (NCC-781) is boarded and captured.

The Earth First movement gains new support and spawns similar groups across the UFP, including on Andor, Tellar and Vulcan. Due to the loss of USS Ranger to the Klingon Empire, Star Fleet develops an intense interest in developing an all-new cruiser class, utilizing the so-called 'third generation' warp propulsion technology.

2219

Texas class light cruiser USS Oklahoma (NCC-945) engages marauders intent on pillaging the settlements on Agnihotra.

The evacuation of 10 million inhabitants of Bayard's Planet is completed.

USS Enderbury (NCC-480, Kovaris phase gun destroyer) is effectively destroyed when a defective pulse wave warhead (Vulcan technology) detonates right after leaving the launcher. The explosion rips open the pressure hull of the destroyer and kills most of the test crew immediately; radiation takes a further death toll.

Paradise planet Hydra II in sector 16C is discovered by USS Poseidon (NCC-780, Mann light cruiser).

USS Constellation (NCC-1017, Advance battle cruiser) suffers major battle damage to her bow structures.

The Caitian species is encountered by the Federation when a Star Fleet ship is accidentally destroyed by them while making first contact. However, the arrival of the first aliens encountered by these felines short-circuits a long civil war between the various planets.

2220

The miniaturization of shuttle warp technology has achieved a new baseline.

2221

The (now) uninhabited Bayard's Planet is fully irradiated by the effects of the 2165 Phi Puma nova.

An expeditionary reinforcement flotilla, consisting of eight Kovaris class phase destroyers, two scouts of the Apache subclass and a single cruiser-tender of the Texas class, visits Rigel V.

USS Arecibo (NCC-1365, Lowell scout) is lost to a puzzling Klingon attack above Sarthong V, a planet of scant strategic but noted archaeological significance.

On a patrol mission out of the Rigel II Fleet outpost, USS Nestor (NCC-L211, Bloodhound corvette) witnesses a rendezvous between a Rigelian transport convoy and a Klingon destroyer, revealing the trade relations between the governments.

2222

USS Republic (NCC-1371, Archon heavy cruiser) is the victim of a rampant internal fire and extensive contamination from fire suppressants shortly after her commissioning.

USS Targa (NCC-467, Kovaris phase gun destroyer) manages to disperse a magnetic storm threatening Balaka III by using her experimental pulse wave warheads - a Vulcan technology.

The Baton Rouge class heavy cruiser enters service with Star Fleet.

Star Fleet grants Chiokis the use of two relatively low-fatigue Horizons: USS Constellation (NCC-1017) and USS Republic (NCC-1371).

Dilithium is discovered to be a naturally-occurring element, on the colony planet Deneva.

2223

In a pyrrhic victory, USS Akula (NCC-275, Placido scout) is lost following combat against Klingons at the Battle of Arquin Pillar, as are the USS Kwajalein (NCC-406, Trent phase gun destroyer) and USS Jacoubet (NCC-479, Kovaris phase gun destroyer). The battle also marked the first of massed sublight fightercraft by a Star Fleet task force, to a dismal failure. Two of the nine Trents deployed to the region fall out and do not make the engagement.

USS Audace (Caracal cruiser) falls victim to unknown enemies - most likely prey to Klingon disruptor cannon. The disappearance of the Audace was only noticed months after the fact; no flight recorder marker was found.

A Federation-flagged mining ship, Castro, is destroyed in the Sussmen-MacFarlane system's asteroid belt by a Klingon DS.



CLASS TIMELINE

In response to the destruction of the *Castro*, the UFP levies sanctions against the Klingon Empire and establishes mandatory trade treaty reviews with all non-UFP states that also do business with the Klingons.

The UFP extends membership to Denobula Triaxa.

2224

Star Fleet decides to crank up cruiser production by any means available.

Following two years of iterative design effort, Chiokis manages to make significant progress on connecting the two hulls of the future heavy cruiser.

2225

Star Fleet's initial plans had Project Starship producing the first high-tech starships this year.

The *Osceola* disaster costs the lives of 277 colonists when a brief stasis synchronization fails.

Star Fleet adopts a new uniform.

2226

USS Moscow (NCC-1423, Baton Rouge heavy cruiser) becomes the first ship to transmit and *USS Tehran* (NCC-1419, Baton Rouge heavy cruiser) the first one to receive a living human being intact through a warp-to-warp transport - an impressive achievement considering that only fifteen years earlier, the very concept had been deemed impossible by the Vulcan Science Council.

The *Constellation* prototype conversion receives a finalized primary hull and the first set of PB-30A third-generation nacelles, as well as an advanced compression fusion main power plant. The ship sets sail on early trial runs.

2228

USS Bastion (NCC-811, Sentinel scout cruiser) is lost fighting a Klingon raiding group. Fighting against overwhelming numerical odds, she demonstrates the inferiority of Klingon preparedness, eliminating five opponents before being lost.

2229

In an emergency meeting, the Chiokis Corporation announces Project Starship will be delayed by at least five more years, moving the projected delivery date to 2239 or later. They offer (along with fellow Andorian shipyard, Salazar Fleet Builders) to build a stop-gap run of 12 light cruisers (of a new design) to help fill the defense requirements.

2230

The Chiokis Corporation has promised this year for the delivery of the first manned full-scale testbed for the starship drive system.

Star Fleet informs Salazar Fleet Builder to cease construction of the final 2 (of six) *Amchitka* light cruisers. The Andorians protest.

The *Bonaventure* dilithium power testbed begins flight tests with the first of four planned configurations.

Star Fleet announces an order for forty ships of a variant of the *Amchitka* light cruiser from Terran and Martian yards. Mass protests erupt on Andor, as a result.

2231

USS Bonaventure (NX-B1) is commissioned.

Star Fleet Division announces that it lacks the capacity to produce all the *Amchitka* variant light cruisers for which it was contracted. Salazaar Fleet Builders obtains two of the required 40 keels, easing tensions on Andor.

Two *Hermes* class scouts are lost to light Klingon ships while on long-range solo missions, in two separate incidents.

In celebration of the early design success, Star Fleet hold another, more public, commissioning ceremony for *USS Bonaventure*.

USS Bonaventure departs on the last (of three) long performance evaluation cruises. Contact with the ship is lost just outside Deltan space. Subsequent searches for *USS Bonaventure* by cruiser *USS Savannah* reveal no debris or ion trails, nor the antimatter residue characteristic of the vented plasma of the experimental ship. All 89 persons aboard are declared missing.

2232

Star Fleet unleashes its designing and engineering teams on the production of a new wave of spaceships, powered by m/am reactors with natural dilithium reaction controls.

2233

A publicity regatta held at Starbase 22 is attended by *USS Sami* (NCC-742, Venture cruiser) and the newly overhauled *USS Tarhe* (NCC-745, Cahuya survey cruiser).

2234

Upon commissioning, the *USS Byrd* (first of her class) begins preparations for her mission towards the galactic core, with six targets of interest and a quarter of a century to visit them.

The crew of *USS Bonaventure* (NX-B1) are declared lost.

USS Byrd departs on her galactic mission.

2235

Test runs of the *Constellation* testbed prove the *Horizon* hull configuration is usable, with a slight altering of engine placement, for the Project Starship design.

2236

Archanis, *Cursa* and *Donatu* all rapidly fall to the newly-expansionist Klingons.

A major Klingon offensive at Zibal is held back because of the perceived proximity of four squadrons of destroyers.



CLASS TIMELINE

USS Charles Kingford Smith (Byrd galactic survey cruiser) departs on her 25-year voyage.

Star Fleet reverts the Hunter class' designation back to corvette, as it became apparent that even these rather modestly armed ships might have to be assigned to the Klingon front.

2237

Altair, Izar, Melev, and numerous fringe worlds, begin discussions of forming non-Federation 'defense zones' inside the Federation.

Councilman Saldran of Rigel IV leads a campaign of Star Fleet black-painting and doomsday predictions.

2238

The Babel Conference of 2238 is the last to be held on Earth.

Councilman Saldran of Rigel IV continues a campaign of Star Fleet black-painting and doomsday predictions.

USS Albert Cushing Read (Byrd galactic survey cruiser) departs on her 25-year voyage.

Dilithium-regulated antimatter reactors had been substituted for the original 4:1 m/am compression fusion powerplants on the Project Starship prototypes.

Project Quarterback is redrawn into a mighty battle cruiser, utilizing the PB-30 propulsion and power system of Project Starship with a tremendous weapons suite.

Construction begins on heavy cruiser Constitution.

USS Constellation is re-activated into Star Fleet service with prototype registry NX-1017.

Star Fleet determines the strategic need for fifty to seventy antimatter-powered deep space escort vessels.

2239

USS Republic is re-activated into Star Fleet service with prototype registry NX-1371.

The Babel Conference is held (and, for the first time, not on Earth).

USS Hood (NCC-1644, Richter cruiser) disappears without a trace while in supposedly routine transit through Andesian-controlled territory.

At least one Richter class cruiser delivers the C-bombs used against the Tobaki dimensional portal.

Star Fleet provides the go-ahead for a production model of the Project Starship heavy cruiser class.

Used PB-29 warp nacelles from the Siva conversions become available to Star Fleet for colonial operations.

2240s

The repeated delays on Project Starship have become such a serious issue that secrecy on the project is on the verge of breaking down.

Star Fleet begins the transition from the spooled warp coil to solid-state technology.

Sorting out meek Imperial reconnoitering missions from reckless privateer raids or the frequent yet futile invasion attempts by weak Klingon factions is a constant pain for Star Fleet border defense forces.

This decade is the first of two that represents the height of perimeter ship combat on Klingon borders.

The decade is remembered as the Great Awakening, with significant numbers of scientific results from deep space exploration. The significance of the Willall challenge upon Klingon politicians and scientists is uncovered.

2241

Star Fleet Intelligence issues a Fleet Yellow Alert regarding Klingon efforts to politically destabilize the UFP.

USS Triton (NCC-439, Syracuse destroyer) is destroyed by a Klingon privateer in a test of Star Fleet mettle.

ACB modulation in Mk II transporter systems is achieved.

A glitch in a Star Fleet logistics management program erased the registry letters for the Type VII containers from the self-organizing central registry records.

The Federation utilizes bioagents in attacks on the Klingon agricultural worlds.

Construction on heavy cruiser Constitution (NX-1700, Project Starship) is completed; class trials begin.

USS Gulliver (NCC-1824, Sawyer light scout), on assignment to assess the political situation in the Axanar system, becomes the first ship to succumb to the Klingon forces there. Historical start of the Four Years War.

USS Bonhomme Richard (NCC-476, Kovaris phase gun destroyer), returning from Babel escort assignment, recovers the recorder marker for USS Gulliver (NCC-1824, Sawyer class), evidently destroyed violently while on assignment to Axanar.

Captain Kelvar Garth of Izar is ordered to assume command of USS Xenophon (NCC-558, Marklin light destroyer) at Starbase 12; around the time of the assumption, a dockside explosion tears a gaping hole in her engineering section and compromises the integrity of her entire spaceframe, an act of apparent Klingon sabotage.



CLASS TIMELINE

CAPT Garth, formerly commanding officer of USS Xenophon (NCC-558, Marklin light destroyer), is re-assigned to heavy cruiser Constitution (NX-1700), and ordered to Axanar to assess the situation, along with Baton Rouge class cruisers Connecticut and Saint Louis.

Heavy cruiser Constitution (NX-1700) approaches Axanar, when the planet declares independence from the UFP and three Klingon destroyers assume an intercept course; Constitution sends out a Code One call for help.

In the First Battle of Axanar (or First Axanar), a Klingon task force engages Star Fleet at Axanar; two Baton Rouge cruisers and four Saladin destroyers from Starbase 12 arrive to ensure a Federation victory.

A Klingon ambush at Lea nearly results in the destruction of the Constitution, already on course to return to Earth for repairs.

The Second Battle of Axanar (or Second Axanar), takes place, with another Klingon defeat and the suicide of Admiral Kkorhetza, commander of the Klingon expedition.

2242

The Federation continues to utilize bioagents in attacks on the Klingon agricultural worlds.

This is the target year for Project Starship.

A distress call from the Donatu system sends Star Fleet scrambling for ships to rescue the frontier colony. Cruisers USS Endeavor and USS Yorkshire are destroyed, before heavy cruiser Constitution, retasked during an evaluation cruise, arrives and engages a series of Klingon cruisers.

Heavy cruiser Constitution (NX-1700) is moved to rear lines to recover, over three years, from her early combat experiences in the vicinity of Axanar and Donatu.

USS Enterprise (NCC-1701) begins construction in the San Francisco Fleet Yards (Earth).

2243

USS Fortune (NCC-805, Sentinel cruiser) self-destructs in order to defeat raiders (later assessed to have been of Ferengi origin or employ). She is the last of her class to be lost.

The Federation makes first contact with the Ariolo, on the planet Fillandia.

Fourteen (of 20) Baton Rouge class heavy cruisers re-enter service following the dilithium regulation engine refit.

The Federation, for the final year, continues to utilize bioagents in attacks on the Klingon agricultural worlds.

It is revealed that the Klingons, too, possess the new m/am reactors with natural dilithium reaction control technology.

The Federation Council places the responsibility of traffic control network erection and maintenance on exploration zones between 100 and 1,000 ly away squarely on Star Fleet, which delegates the chore to Star Fleet Logistics.

2245

USS Troy (NCC-423, Siva destroyer) and USS Hellas (NCC-426, Siva destroyer) succumb to Klingon forces at Delta Leonis.

Pre-commission Ares (NCC-602, Monoceros scout) is damaged beyond salvage during the final construction phase, in what appears to be an accident.

This year's defense review seals the fate of numerous pre-dilithium ship types.

Additional recycled PB-28 warp nacelles are no longer available, so production of new ones now supports the Cochrane class construction.

USS Enterprise (NCC-1701, Constitution heavy cruiser) is commissioned, with program manager CAPT Robert April in command. USS Constitution (NCC-1700) is commissioned shortly after.

USS Republic (NCC-1371, Constitution heavy cruiser) is re-commissioned.

USS Constellation (NCC-1017, Constitution heavy cruiser) is re-commissioned.

In the Final Battle of Axanar, the "battered" heavy cruiser USS Constitution and three of her "half-finished" sisters are moved to the forward repair base in orbit of the planet as a lure. Star Fleet adopts a new uniform.

2246

A series of aggressive incidents by the Klingons begins, impacting multiple Nelson class scouts and rearranging Star Fleet priorities.

USS Morgan City (NCC-2704, Loknar frigate) falls prey to a Klingon strike, is captured and repaired, and adopted as part of the Klingon forces.

A period of time, that lasts until 2265, begins wherein there is very little direct, coordinated military action against Klingon forces, due to a decrease in the intensity and coherence of their piracy raids.

2247

Alohk Ixan begins his administration as Federation President.

2248

USS Republic (NCC-1371, Constitution heavy cruiser) is re-assigned to training duty.

Heavy cruiser USS Bonhomme Richard (NCC-1712) begins construction.

The final newbuild Constitution class heavy cruiser (USS Potemkin, NCC-1711) is completed.

USS Valdez (NCC-4488, Nelson scout) is captured by Klingon privateers.



CLASS TIMELINE

2249

The UFP brings the Humans of Polar City (and other colonies on Rigel IV) into its jurisdiction (but not membership), in order to provide protection.

The UFP extends membership to Risa.

USS Cassegrain (NCC-1429, Hale scout) is hijacked by renegade Andorians, who set the crew adrift and disappear to parts unknown with cargo holds full of various weapons components.

USS Bodiri (NCC-2717, Loknar frigate) sees action against Lesser Orion pirates, thwarting an invasion of a prime directive-protected class L world in the Secundi Bahia system.

2250

USS Sindbad (NCC-1823, Sawyer class light scout) has the distinct honor of carrying President Varis to Axanar for the signing of the Rehabilitation Treaty.

Axanar rejoins the Federation.

USS Vasco da Gama (NCC-1472, Aldrin deep space frigate) is lost in an engagement with the Klingons.

The series of aggressive incidents by Klingons begun in 2246 concludes.

The first Constitution class heavy cruiser enters drydock for upgrades to Flight II configuration.

2251

As more modern cruisers enter service, the five re-activated Caracal class command cruisers are again retired and sold to the Ktarian defense fleet (following re-engining).

The first Constitution heavy cruiser Flight II returns to service.

The Bonhomme Richard subclass heavy cruiser enters service with Star Fleet.

2252

Vulcans discover Zebulon Carter's journal on the planet, and return it to the United Earth government.

The United Federation of Planets makes first contact with Bolarus IX.

The final newbuild Bonhomme Richard class heavy cruiser (USS Essex, NCC-1727) is completed.

2253

Alohk Ixan concludes his administration as Federation President.

2254

The colony world of Prairie is attacked by Klingon forces.

USS Ulysses (NCC-1814, Sawyer light scout) proves that the Klingon threat has not receded by stumbling to an extensive attempt to influence Prime Directive-protected planets inside Federation territory.

USS Brazzaville and USS Providence, both Nelson scouts, are lost to Tholian-associated forces in separate incidents.

USS Cortez (NCC-1834, Miranda heavy frigate) is lost to the Vulcanoids of Darien 224.

USS Achilles (NCC-1248, Benning heavy frigate) is destroyed in the Battle of Theta Kalyb with all but 53 of her crew.

2255

The Sheliak Conflict quickly starts and ends with the drafting of the Treaty of Armens.

Two convoys, including Bering class cargo drones and escorted by light cruisers, engage the (presumably Klingon) enemy.

Siva Flight II destroyer USS Alexandria (NCC-422) is destroyed and another two, USS Carthage (NCC-428) and USS Massilia (NCC-421) are damaged in an audacious ramming attack by Klingon special forces at Starbase 19. Losses of personnel are light, but material damage is too great to warrant repairs of the crippled destroyers.

Select Constitution class heavy cruisers start receiving specified upgrades.

The Star's End colony is founded, the largest single sortie within the construction history of the Cochrane class colonizer.

The Federation dreadnought class enters service with Star Fleet.

2256

USS Penelope (NCC-G1415, Sherman class) falls into Orion hands with a full load of dilithium; a special forces operation to retrieve it is successful.

The final Constitution Flight I to be upgraded to Flight II configuration is completed. USS Potemkin (NCC-1711) is the only Constitution to not receive the upgrade; instead, she begins a conversion to the Bonhomme Richard standard. Other Constitution Flight IIs also begin the same conversion.

Constitution Flight II heavy cruisers USS Enterprise, USS Farragut, and USS Lexington (NCC-1701, -1702, & -1703, respectively) undergo conversions to the Bonhomme Richard Type 2 configuration.

Constitution Flight II heavy cruisers USS Exeter, USS Hood, and USS Intrepid (NCC-1706, -1707, & -1708, respectively) undergo conversions to the Bonhomme Richard Type 3 configuration.

2257

USS Byrd (first of her class), on the return leg of her 25-year voyage, re-enters communications range.



CLASS TIMELINE

USS Republic (NCC-1371, Constitution heavy cruiser) is deactivated (mothballed).

2258

USS New America (NCC-2706, Loknar frigate) tractors to safety a Federation starliner that had suffered an impulse drive malfunction on approach of Procyon and was in danger of plunging into the chromosphere of the star with 400 people aboard.

USS Inuit (NCC-747, Cahuya survey cruiser) is lost at Azha to consumption by a spaceborne lifeform of a type common in the region (though, at the time, it was presumed to be due to an encounter with Klingons).

USS Sverdlov (NCC-1238, Coventry strike frigate) fails to return from a test run of the new PB-51 series engines.

2259

The last Jidai subclass reconnaissance cruiser is lost to enemy action.

USS Iblis (NCC-528, Siva Flight II destroyer) hits the battle cruiser USS Newton (NCC-3822 Proxima battle cruiser) with her navigational deflector, killing 23 aboard the latter ship.

USS Byrd (first of her class) returns to New Aberdeen upon the conclusion of her 25-year galactic survey voyage and enters a 2-year overhaul period.

USS Dauntless (NCC-1697, Pyotr Velikiy support cruiser) is badly damaged in combat at Xarant, retires to Starbase 7 for repairs.

USS Gaikos (NCC-2740, Loknar frigate) evacuates 400 people from a failed terraforming outpost from under severe tectonic trouble.

2260

Klingon ships begin a series of frequent raids into UFP territory.

Light cruiser USS Texas (NCC-1900) defeats a Klingon D6 cruiser at Iota Eridani.

The United Federation of Planets rejects the membership bid by Bolarus IX, claiming the Bolians remain unstable. A world government would have to survive the coming of a new generation for the Bolians to prove their commitment to world peace.

Altair rejoins the UFP.

USS Smith (Byrd class galactic survey cruiser) returns a bit early from her 25-year voyage.

The President of the United Federation of Planets is selected—for the first time—by general election.

The final Constitution Flight II is upgraded to Bonhomme Richard configuration.

The ships having served longest in the Bonhomme Richard configurations are the first to be upgraded to the Constitution Flight III.

2261

USS Sheridan (NCC-4463, Larson destroyer) is lost with all but three hands on her maiden voyage to a power system explosion that could not be contained.

The Memory Alpha planetoid is selected, as an event during the Centennial Survey, for all the archives of the UFP's cultural and scientific knowledge. The eight-year development of the project begins.

The plight of Uzor becomes apparent to the people of Bolarus IX: it would be uninhabitable in less than a decade. Solar instability threatens to wipe out the entire Uzor system.

USS Skagerrak (NCC-G504, Bering class) is lost to 'therspace', after rescuing a Tellarite crew.

USS Virgo (NCC-1572, Taurus cruiser) is lost from unknown causes while scouting in the direction of Zeta Persei.

Having completed a multi-year refit, USS Byrd (first of her class) launches on her second galactic survey, a 13-year voyage.

The Constitution class heavy cruisers start receiving transporter upgrades.

USS Cromwell (NCC-4477, Larson destroyer) takes refuge on Delta Canaris VI after the nacelle is ripped out and life support compromised by a relativistic-speed meteoroid cloud.

2262

Bolarus IX develops and initiates an assistance plan for the people of Uzor: mass colonization of a nearby planet for the Uzorian refugees.

Melev rejoins the UFP.

USS Atlanta (NCC-1440, Baton Rouge heavy cruiser) fights Orion forces in a completely successful mission of apprehending suspected, as well as known and convicted, pirates with zero casualties.

During Exercise Have Gun, USS Azrael (NCC-527, Siva Flight II destroyer) suffers a major atmospheric leak and loses 12 crew when she drifts too close to the black star TNC 65823 and, while disoriented, collides with the shields of the dreadnought USS Dominion (NCC-2115, Federation dreadnought).

The Federation makes first contact with Delta IV (i.e., the Deltans).

2263

The UFP recognizes Orion sovereignty and neutrality on issues that had formerly been considered criminal activity.

Having completed a multi-year refit, USS Read (Byrd galactic survey cruiser) launches on her second galactic survey, a 13-year voyage.

Construction begins in Earth orbit on the Ournal class Earth Spacedock.



CLASS TIMELINE

Heavy cruiser USS Victory (NCC-1760) begins construction.

USS Cromwell (NCC-4477, Larson destroyer) returns to service after successful recovery and repairs.

A five-ship expedition is lost in contested space near Romulan territory; only the severed warp nacelle of USS Alesia (NCC-4454, Larson destroyer) remaining to tell of its demise.

The Orion cartels are provoked by the Atlanta operation and attack the dilithium-rich world of Ghioghe. Heavy cruiser USS Levant (NCC-1442, Baton Rouge class), commanded by Commodore Sieren, and light cruiser USS Sutherland (NCC-1010, Texas Flight II), commanded by Commander James Kirk, are both lost in the Battle of Ghioghe.

2264

Three mothballed Daedalus class starships are recommissioned for use by the SCE's Starship Contingent Teams.

The final Bonhomme Richard subclass heavy cruiser (original & Type 3) undergoes conversion to the Constitution Flight III configuration.

2265

The SS Valiant's recorder-marker is recovered and the fate of the missing vessel is realized.

USS Antares (NCC-F501, Sherman light transport) is destroyed by the metahuman powers of a young crash survivor.

USS Smith (Byrd galactic survey cruiser) launches on her second galactic survey voyage.

The final Victory subclass heavy cruiser (USS Rivoli, NCC-1765) is completed.

Klingon ships end a series of frequent raids into UFP territory.

Star Fleet adopts a new uniform.

The period of time that began in 2246, with very little direct, coordinated military action against Klingon forces, ends.

USS Bombay (NCC-1838, Miranda heavy frigate) is lost on a deep-space assignment.

The final Bonhomme Richard Type 2 heavy cruiser (USS Enterprise, NCC-1701) undergoes conversion to the Constitution Flight III configuration.

2266

Augment leader Khan Noonien Singh's escape from Earth is discovered when his ship is found adrift in space in the Mutara sector, some fifty lightyears away.

Klingon hostilities peak.

USS Ball (NCC-1691, Flagstaff scout drone) distinguishes herself by rescuing the crew of prospector SS Malverne.

The Federation class dreadnoughts enter a heightened operational readiness, in anticipation of Klingon hostilities; they'll practice offensive, as well as defensive, maneuvers until mid-2267 and the abortive Klingon invasion.

2267

The Altair systems inaugurates a new president, which helps stabilize the region.

USS Niantic (NCC-1105, Miramar heavy scout) is lost in action on the hunting grounds of an alien planet-eating device.

USS Constellation (NCC-1017, Constitution heavy cruiser) is sacrificed, in order to destroy the Doomsday Machine.

A cessation of hostilities with the Klingons is mandated by the Organians.

USS Affiliation (NCC-2108) and USS Federation (NCC-2100) are in striking range of Gohrem and Kassat, the main garrison worlds before the industrialized core area of the Empire, when the call for truce comes through from the tiny agrarian world of Organia.

Sixteen pirate attacks are connected to Orion activity all along the crucial Rigel shipping lane, and several dozen more are suspected of having been committed by Orions.

The logistics of supporting the anti-piracy efforts becomes extremely difficult.

Salazar Fleet Builders receives orders to begin dismantling Amchitka class light cruisers, resulting in protests on Andor.

2268

USS Lovell (NCC-188, Daedalus survey cruiser) is destroyed by the Shedai in the Taurus Reach region.

USS Woden (NCC-G325, Wanda class) is destroyed in a friendly fire incident.

In the most devastating and public loss of an Icarus battle cruiser, USS Golden Hind (NCC-1142) misjudges a warp approach and slams into Devon, blasting a huge crater in the surface and killing thousands by direct and secondary shockwave and radiation effects.

Following the Golden Hind tragedy, Star Fleet orders the idling of all ships equipped with the PB-27 nacelle; recall orders are issued across the operating theater.

USS Dauntless (NCC-1697, Pyotr Velikiy support cruiser) is severely damaged in combat with Klingon rogues and retires to Starbase 11 for repairs.

The outer frame of the Ournal class Earth Spacedock is completed.



CLASS TIMELINE

USS Intrepid (NCC-1708, Constitution heavy cruiser) is destroyed by an incredibly huge, simple cellular being.

USS Buenos Aires (NCC-1840, Miranda heavy frigate) is lost on a deep-space assignment.

USS Malacca (NCC-F2032, Aakenn heavy transport) is destroyed in a covert Klingon operations strike at Starbase 47.

The Thuringia class surveyors are suddenly recalled from their deep-space assignments.

2269

As it nears formal completion, the Memory Alpha complex is heavily disrupted, and all personnel killed, during an assault by the Zetarians.

USS Enterprise (NCC-1701, Constitution heavy cruiser) hunts down and forces the surrender of the Orion murderers of four of the crew of the Honor subclass transport USS Huron (NCC-F1913).

USS Enterprise accidentally enters an interspatial anomaly in the Delta Triangle region and locates the derelict USS Bonaventure (NX-B1) among hundreds of other lost spacecraft of varying origin. Enterprise is unable to contact nor rescue the test vehicle.

Persistent reports regarding the lack of Organian interference towards Klingon aggression are made by Star Fleet captains, from this year through 2284.

2270

Based upon the nearly 80% evacuation of Uzor by the Bolians, Bolarus IX is offered—and accepts—membership into the United Federation of Planets.

CDR Paul Burch and a supporting team steal USS Star Empire (NCC-2116, Federation dreadnought) before her completion, resulting in the exposure of a major conspiracy in the ranks of Star Fleet.

USS Pompeii (NCC-424, Siva Flight II destroyer) is destroyed with all hands by USS Enterprise (NCC-1701, Constitution heavy cruiser), as part of the 'dreadnought conspiracy'.

The last of the Constitution heavy cruisers pull in from their exploration missions, after three decades of operation.

2271

A new weapons classification system is adopted by Star Fleet, defining individual systems as either 'light', 'medium' or 'heavy' in nature.

The battle at Klach D'kel Brakt takes place between the Klingon and Romulan empires.

Star Fleet adopts a new uniform.

2272

USS Trailblazer (NCC-1596, Kitty Hawk cruiser), in service to TacFleet, is rendered un-spaceworthy (but not in combat with an enemy) and stricken from the Fleet rolls.

USS Recovery, a massive rescue drone prototype, is lost during its space trials due to sabotage by Tholian forces.

USS T'Pool (NAR-24307, Thuringia surveyor) is crippled by an unexpected coronal mass ejection during a standard nova survey.

The huge, autonomous vessel known as V'Ger approaches Earth after passing through a portion of the Klingon Empire. This initiates the early launch of the heavy cruiser USS Enterprise (NCC-1701), having almost completed refit to the Enterprise standard.

2273

Betazed is admitted into the United Federation of Planets.

Earth Spacedock is completed and operationally replaces Spacedock One.

The second (of 8) Enterprise subclass heavy cruiser is re-launched, in a conversion run that lasts into 2279.

2274

USS Byrd (first of her class) returns from her second and final galactic survey. After decommissioning, she is placed in orbit around Aldebaran as an exhibit of the history and exploits of the entire class.

Interior outfitting of the operational Earth Spacedock is completed.

Two ships, USS Carmichael (NCC-4705) and USS Henley (NCC-4713), both Wilkerson destroyers, collide in a tractor beam misfire while pulling alongside a replenishment station, with containment failure on both vessels resulting in the loss of 730 lives.

2275

The use of letter codes for non-line ships' registrations is discontinued for all newly-ordered vessels.

The United Federation of Planets extends membership to Rigel III (the Chelarians).

The colony of Belle Terre is founded.

2276

USS San Diego (NCC-1441, Baton Rouge heavy cruiser) conducts a classified mission to the heart of the Romulan Star Empire.

Heavy cruiser USS Victory (NCC-1760) begins an infiltration mission into the Romulan Star Empire through the Fire Swamp Nebula.

Operation Grey Ghost, Star Fleet's adventurist Romulan expedition, includes the 6 Texas-refitted Navigator light cruisers and USS Eagle (NCC-956, Texas light cruiser).



CLASS TIMELINE

SS Read (Byrd galactic survey cruiser) returns from her second and final galactic survey.

2277

USS Kongo (NCC-1710, Constitution heavy cruiser) suffers a crippling onboard explosion.

The final Constitution Flight III heavy cruisers are either refitted or decommissioned.

2278

USS Smith (Byrd class galactic survey cruiser) returns from her second and final galactic survey.

Star Fleet adopts a new uniform.

2279

USS Hunley rescues the crew of the Ohio-type tug SS Dakota (NDF-8302) from Romulan forces in a rare raid across the RNZ.

The last (of 8) Enterprise heavy cruiser subclass conversions is completed.

2282

The Federation makes first contact with the Xeletians in a deep-space encounter.

2284

The first contact report about Tellar from the SS Leif Eirickson, transmitted via radio, reaches Earth.

The last of the persistent reports—regarding the lack of Organian interference towards Klingon aggression—from Star Fleet captains since 2269 are made.

2285

The Genesis Crisis, a diplomatic event with the Klingons, erupts.

USS Hamilton and USS Ark Royal, both Titan sub-class shuttlecarriers, are brought out of mothballs and refurbished in response to a period of heightened Klingon tensions.

2286

A method to recrystallize dilithium using fission power is realized.

USS Republic (NCC-1371, Constitution heavy cruiser) is stripped of all armament, save for a single ceremonial laser, and reactivated as an Academy training ship.

2287

The United Federation of Planets extends membership to Rigel IV (the Human colonists).

Childress Camp on Rigel XII becomes a key refining plant for the entire sector, when the dilithium extraction equipment arrives.

The first of twelve Kovaris subclass (of the Trent class) light destroyers (all of the torpedo type) are reactivated and upgraded for emergency service in the wake of the Organian disappearance.

2288

The last of twelve Kovaris subclass (of the Trent class) light destroyers (all of the torpedo type) are reactivated and upgraded for emergency service in the wake of the Organian disappearance.

2289

The UFP extends membership to Xeletia.

USS Republic (NCC-1371, Constitution heavy cruiser) is again deactivated.

The colony of Ivor is founded.



STARSHIP COMPARISON GUIDE

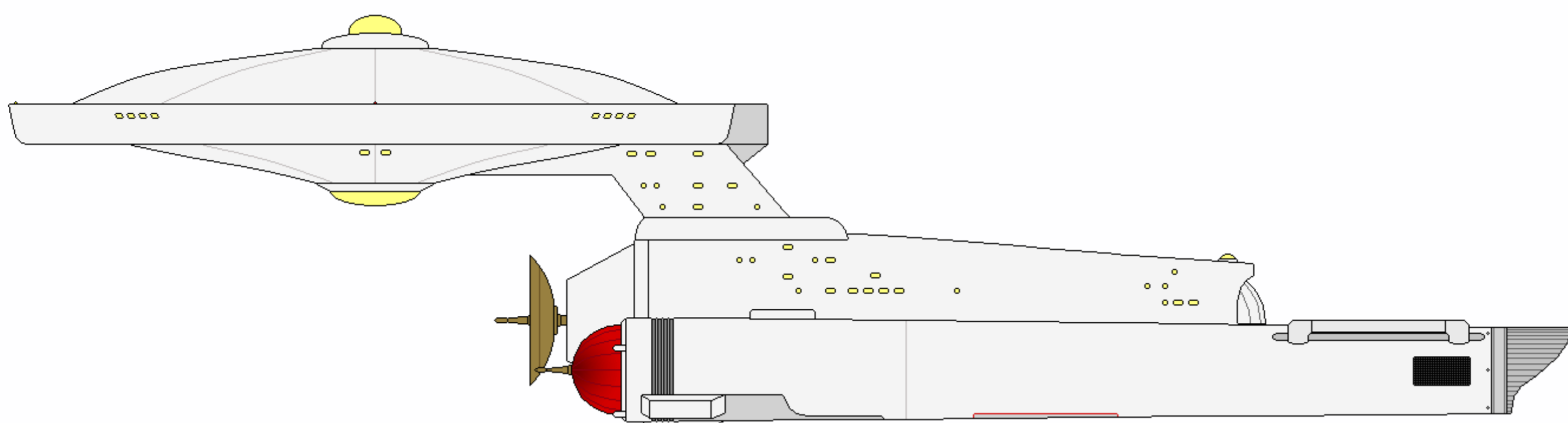

CONSTELLATION
FUSION TESTBED

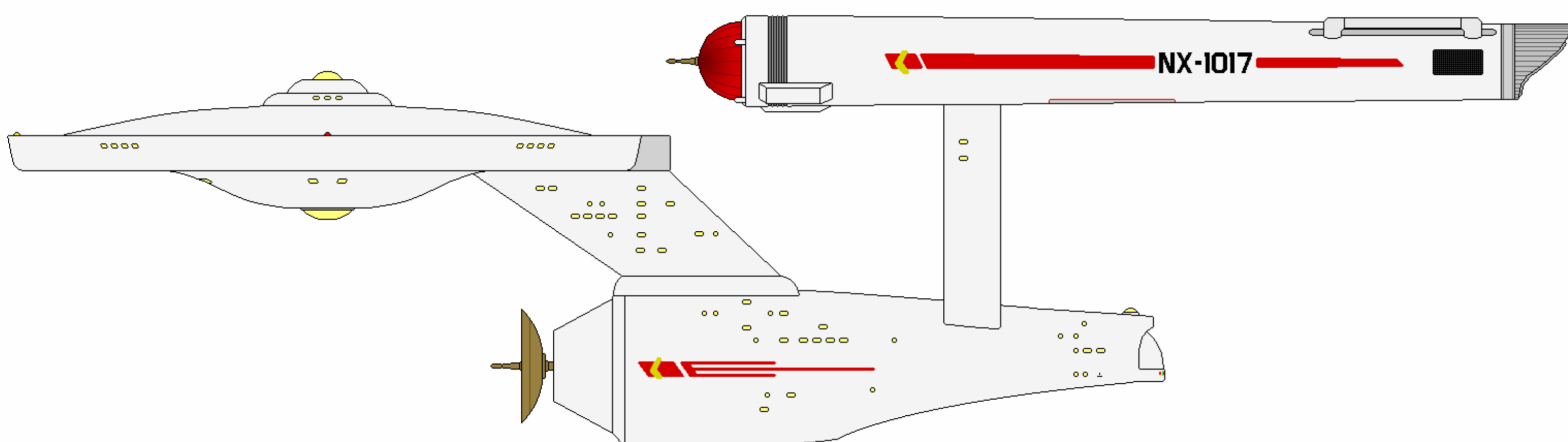

CONSTELLATION
DILITHIUM TESTBED

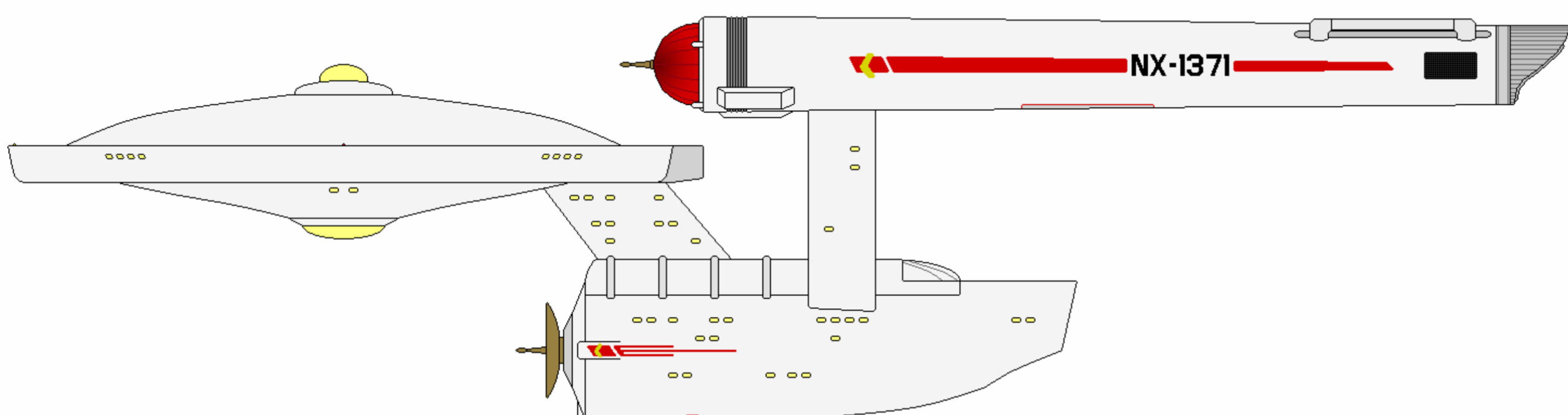

REPUBLIC
HEAVY CRUISER
PROTOTYPE

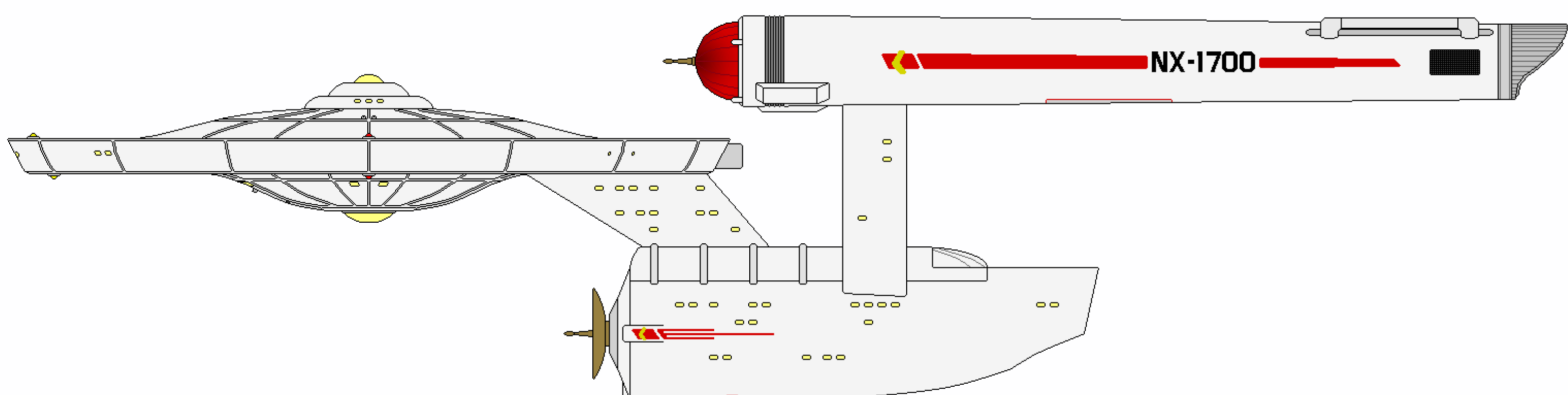

CONSTITUTION
HEAVY CRUISER
PRODUCTION PROTOTYPE

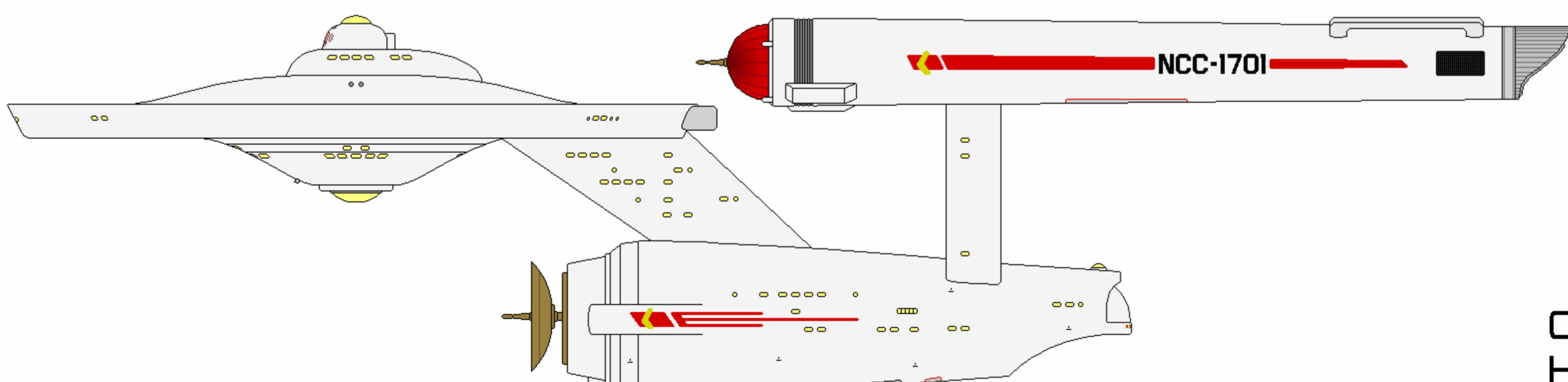

CONSTITUTION
HEAVY CRUISER

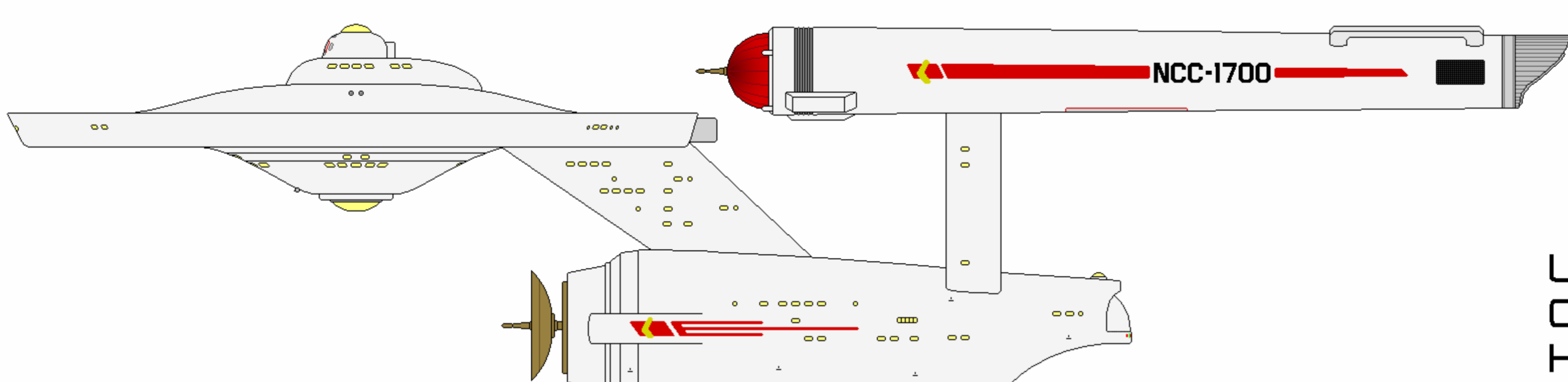

USS CONSTITUTION
CONSTITUTION
HEAVY CRUISER
OPERATIONAL STANDARD

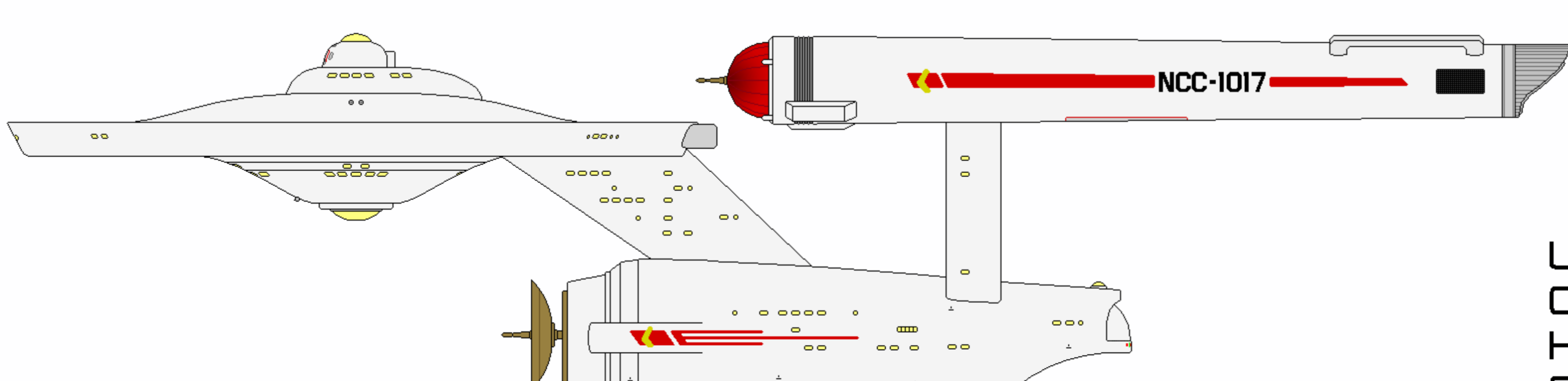

USS CONSTELLATION
CONSTITUTION
HEAVY CRUISER
OPERATIONAL STANDARD

STARSHIP COMPARISON GUIDE

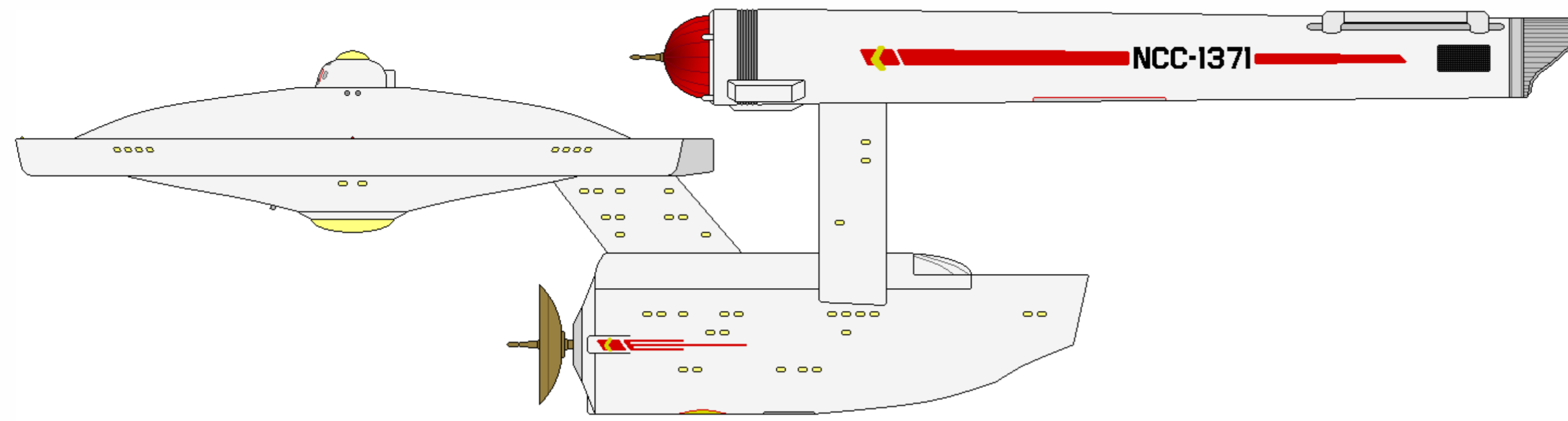

USS REPUBLIC
CONSTITUTION
HEAVY CRUISER
OPERATIONAL STANDARD

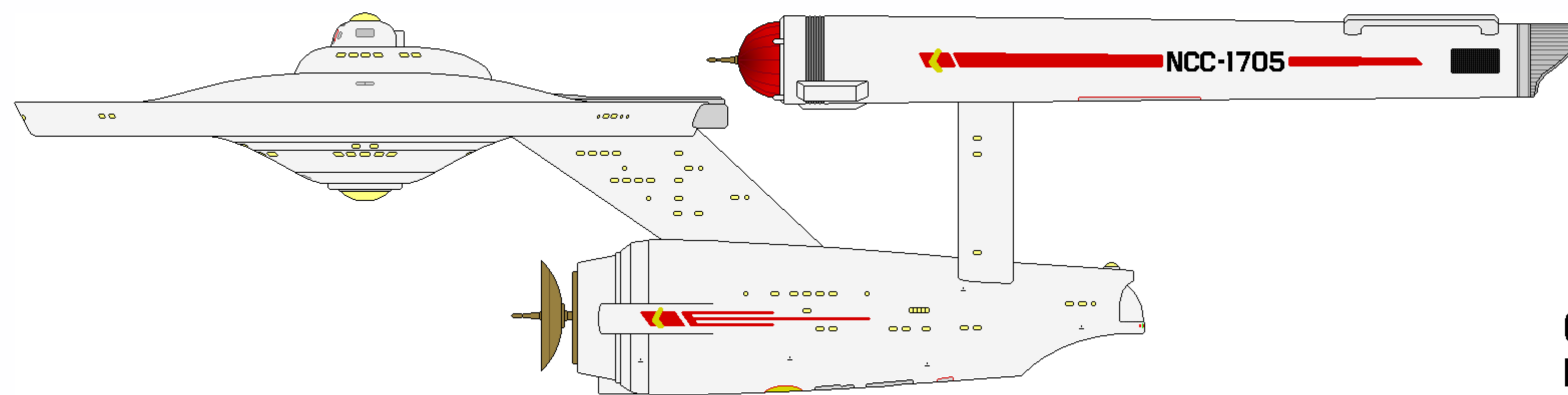

CONSTITUTION FLIGHT II
HEAVY CRUISER

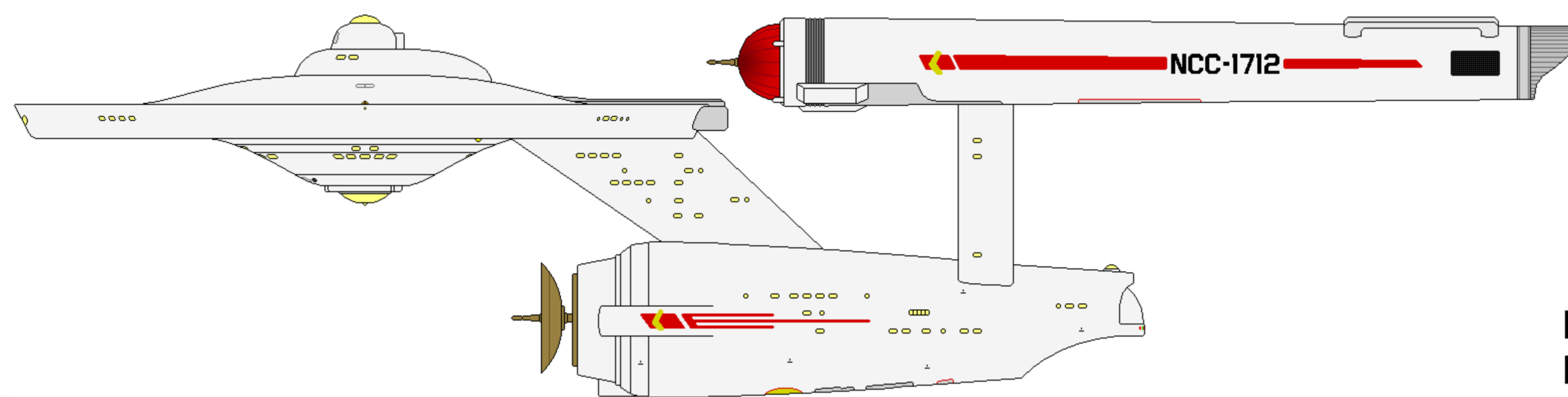

BONHOMME RICHARD
HEAVY CRUISER

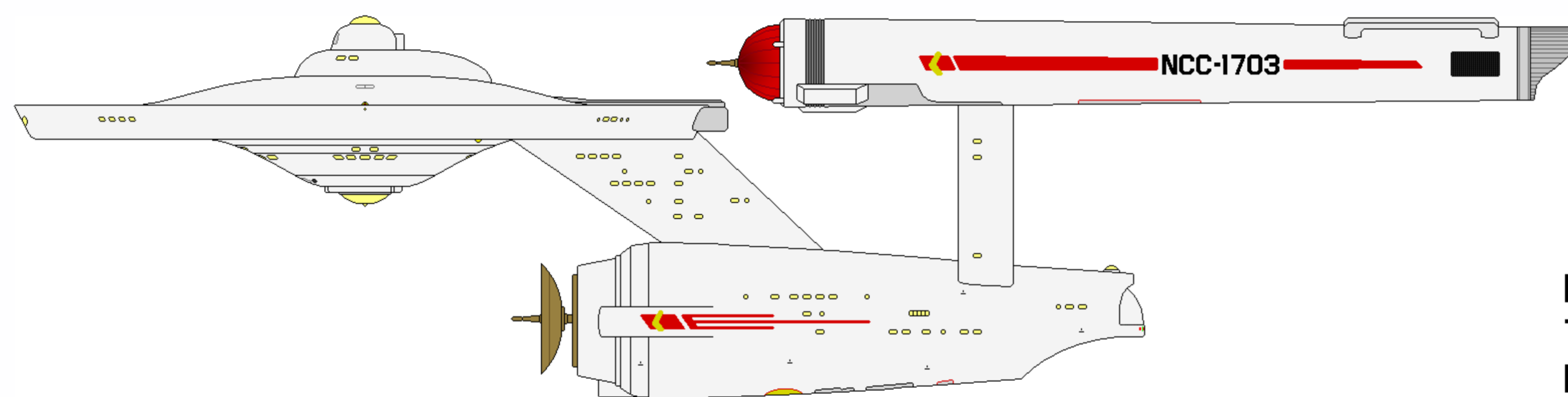

BONHOMME RICHARD
TYPE 2
HEAVY CRUISER

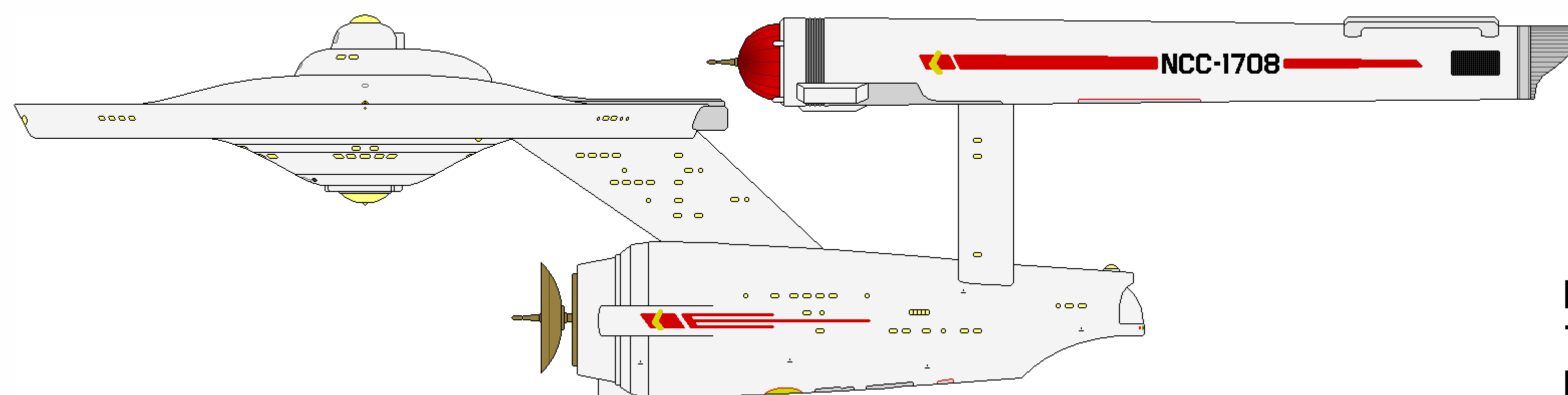

BONHOMME RICHARD
TYPE 3
HEAVY CRUISER

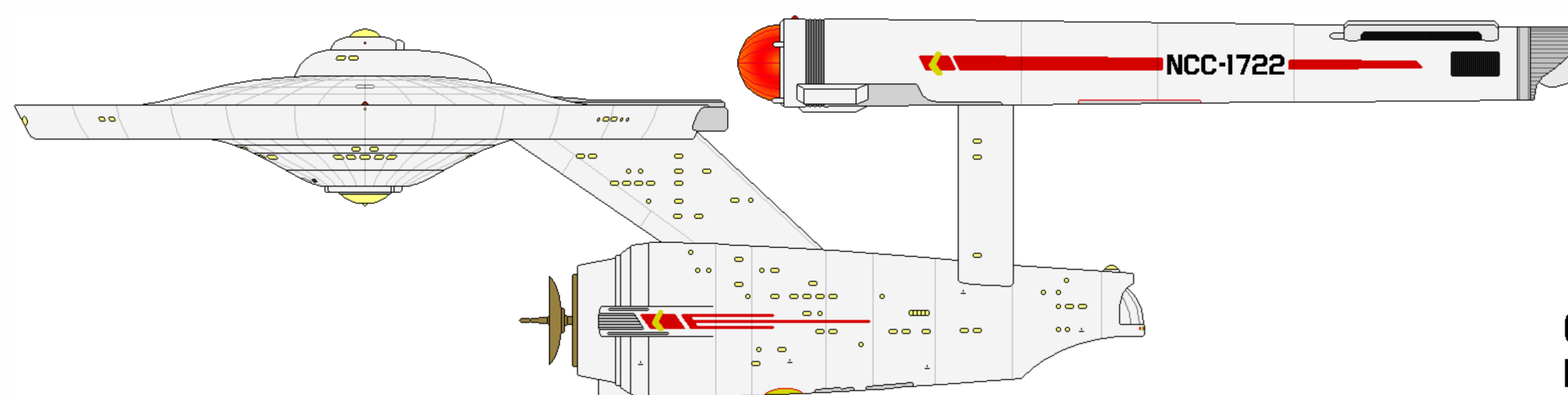

CONSTITUTION FLIGHT III
HEAVY CRUISER

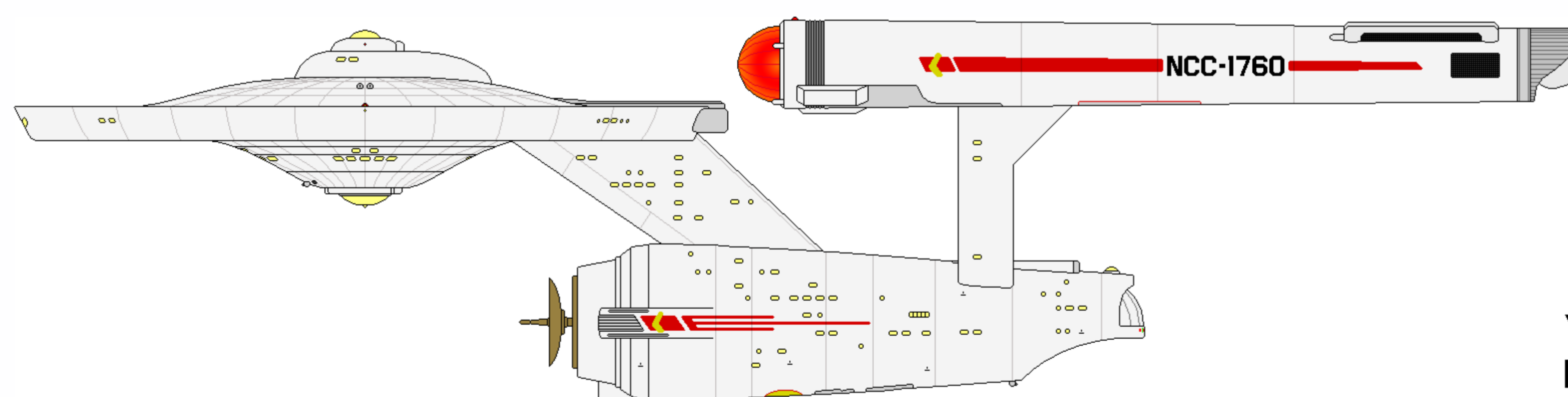

VICTORY
HEAVY CRUISER



STARSHIP COMPARISON GUIDE

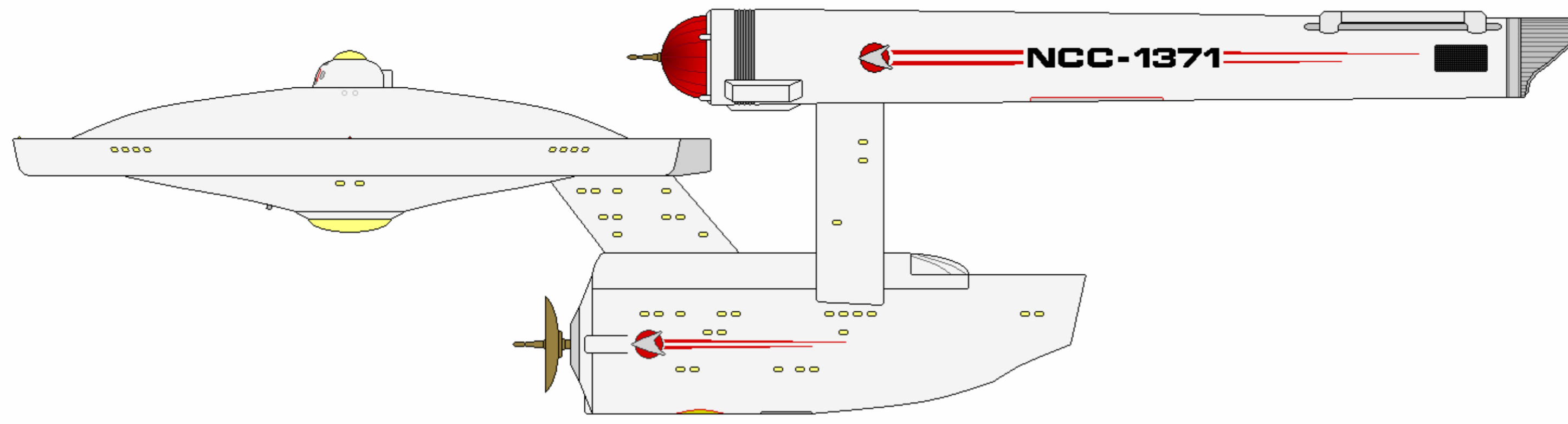

USS REPUBLIC
CONSTITUTION
HEAVY CRUISER
(ACADEMY TRAINER)



GLOSSARY

Array: Generally, a combination of identical sensors, weapons, or other equipment operating in conjunction.

Barge: one of several differing types of vessels, including 1) a low-warp bulk carrier designed to transport unpackaged bulk cargo; 2) an orbital-to-atmosphere combat lander, usually heavily armored and lightly armed, to transport large troop formations into defended surface areas.

C/P/S: Centerline/Port/Starboard (see P/S).

Class: a production run of vessels all to identical (or nearly identical) standards. Ex: the Constitution class

Corvette: Small warp-capable ship dedicated to local patrol, law enforcement and community service missions. Sometimes landing-capable, not dependent on starbase facilities for support.

Cruiser: A medium multi-purpose starship. The largest exploration vessels until the early 24th century, when relegated to other duties with the introduction of large Explorer starships.

Deep space: The region near or beyond the recognized borders of the Federation, often uncharted in any considerable detail.

Destroyer: A medium offense starship intended for destroying enemy capital ships and installations, as well as conducting fleet escorts.

ECS: Earth Cargo Ship, a prefix for vessels flagged under the governing authority of the Earth Cargo Service.

ELRS: Extreme Long Range Sensor

Flight: A modification to a class of ship intended to be incorporated by most or all members of that class.

Flitter: an extremely low-altitude planetary personnel and freight vehicle, utilizing anti-grav hover equipment. Larger vehicles might resemble wheel-less trucks, with the smallest analogues to one- or two-person motorcycles.

Frigate: Until the late 22nd century, a dedicated medium defense and escort starship, larger than corvette but smaller than destroyer, often capable of trans-atmospheric operations. In the 23rd century and into the early 24th century, often used to designate defense and escort starships ranging from small patrol and escort ships typically lacking torpedo armament to versatile multipurpose ships similar to light cruisers.

FTL: abbreviation for Faster Than Light.

GW: GigaWatt

Hopper: a small vehicle designed for atmospheric flight. While some may have limited aerospace capabilities, they are generally utilized for intra- and intercity transport of personnel.

ISA: International Space Agency. Formed by the NUN in 2018 in an effort to coordinate international space exploration missions. Succeeded by both the UESPA and UESN in 2067 and 2069, respectively.

Ishakawa-Dell Barrier: The exponential growth in the power required by early warp nacelles as FTL speeds approached warp factor 6 (on the OCU scale).

Laser: Typically, a secondary weapon on early space vessels. Current shielding technology has largely negated the threat posed by the coherent electromagnetic beam.

M: Meters

M/AM: Matter/Antimatter

MT: Metric Tons

Navigation Light: Yellow in color; these lights are generally located on or near major points of superstructure of a space vessel. They often provide low-emission positioning signals for specific locations on and within the vessel for the purposes of proximity maneuvering by another vessel and relative destination positions for transporters. Not to be confused with red or green running lights.

NCC: Letter prefix in UFP Starfleet vessel registries, anecdotally said to come from the term Naval Construction Contract. Current usage has letter N signifying UFP registry, and CC signifying active Star Fleet forces.

Nearspace: The region of the Federation considered to be internal, fully charted, and uncontested.

NUN: New United Nations. Formed in 2011, first dissolved in 2053 (during the Third World War), re-formed in 2065 (two years following First Contact), then finally dissolved in 2079. Authorized the formation of the ISA (2018), UESPA (2067), UEDP and UESN (both 2069). Succeeded by the UEDP



GLOSSARY (CONTINUED)

OCU: Original Cochrane Units, representing the original warp scale, where the warp factor cubed was the velocity in c, the speed of light.

Operational Standard: the description and designation for a previous testbed or prototype vessel that has been made operational, though not necessarily to the standards of the official class. Ex: USS Constellation (operational standard)

P/S: Port/Starboard; left & right side, respectively, in naval parlance.

Particle Cannon: A primary or secondary weapon on some early space vessels, though generally replaced by phaser technology. The weapon accelerated charged or neutral matter (or antimatter) particles to relativistic speeds. Also commonly known as phase cannons.

Phase Cannon: (see Particle Cannon)

Phaser: A directed-energy/particle weapon in common use aboard Star Fleet vessels, as well as other UFP and foreign fleets. Based upon rapid radion effect, it generates a wide-band particle beam utilizing both electromagnetic and subspace components.

Plasma Cannon: A projectile weapon in common use aboard early space vessels. A sublight weapon, the cannon generates, contains, and directs the release of ionized matter. The weapon is often complemented by particle and/or laser weapon systems.

Prototype: a vessel constructed (or modified) to perform tests and trials of a potential new class (or subclass) of ship.

Running Light: Red (port/left) and green (starboard/right) lights traditionally denoting the observed side of a water vessel under low light conditions. Utilized for similar purposes by space vessels of the UFP though generally for rapid orientation by the pilots/helms of other vessels maneuvering in close proximity. Not to be confused with yellow navigation lights.

SCE: (see Star Fleet Corps of Engineers)

Scout: A small to medium, fast research and/or reconnaissance space vessel, equipped with extensive sensor and research equipment. Though protected by defensive energy weapons, most substitute probe launchers for torpedoes.

Series: a succession of vessels all deriving from one standard, comprised of the original class, subclasses, flights, and types. Ex: the Constitution series

Shuttle: An auxiliary craft usually carried by larger vessels for orbit-to-ground transportation or detached operations. Also used for starbase liaison duties.

Shuttlepod: Very small auxiliary craft used for ship-to-ship or orbit-to-ground transportation, free-space maintenance, and repair work, and detached operations of a very limited nature. Usually not equipped with a warp drive.

Star Fleet: The primary exploration and defense organization of the UFP. Formed in 2161 to protect the integrity of the Federation and the safety of its members and to expand the knowledge of the member cultures.

Star Fleet Corps of Engineers: the special construction, maintenance, repair, and public engineering management agency (an echelon of Star Fleet Engineering) for both Star Fleet and the Federation. The SCE is often tasked with building and maintaining facilities both standard and exotic, as well as providing rapid response to engineering problems that occur far from Federation resources.

Starfleet: Short-hand name for the United Earth Starfleet (UESF), the primary exploration and defense organization of United Earth 2033-2161. Not to be confused with the UFP Star Fleet. Renamed Earth Fleet upon the formation of the United Federation of Planets.

STL: abbreviation for Slower Than Light.

Subclass: A significant variant of a given class of ship, usually newbuilds, though sometimes including important modifications to existing ships, that are not intended to replace the existing ships of the original class. Often named for the first ship to reach that final intended production standard.

Tender: An auxiliary vessel specifically designed for deep space replenishment and support of starships and other vessels. While often equipped with a tractor device, the inability to efficiently tow another vessel in warp distinguishes the tender from a tug.

Testbed: a vessel constructed (or modified) as a platform to test new technologies, with the vessel not necessarily transitioning to an operational status.

TNG: Terrance-Nelorr Graduated scale where upon each full warp factor is achieved when a certain number of cochranes were met in output, resulting in more efficient engine plateaus. In this scale, Warp 10 is unattainable.

Torpedo: The general designation for warp-capable guided projectile weapons, in contrast to sublight-only guided missiles.



GLOSSARY (CONTINUED)

Transport: A Starship or other vessel dedicated to transporting passengers or cargo. They range in size from small two- or three-crew ships to huge starships and freighters.

Transwarp Drive: The common name for drive systems capable of higher speeds and efficiencies than the warp drive currently in use throughout the Federation. Promising venues of research include deep subspace immersion, new power regulation methods, dimensional rift techniques, and time manipulation. No practical drives of these types are yet available at this time.

Tug: 1) A warp-powered ship specifically designed to extend her warp field around objects that can thereafter be towed at warp speeds. Primarily used for the carriage of transport pods and towing of disabled starships or other equipment lacking appropriate motive capabilities. 2) A craft designed to propel ships or equipment lacking motive power about a limited area of operation, such as a space dock or construction site. May also refer to such a vessel intended to assist ships maneuvering within and in the vicinity of docking facilities.

TW: TerraWatt

Tyme Barrier: The exponential growth in the power required by early warp nacelles as FTL speeds approached warp factor 7 (on the OCU scale).

Type: a variant to a class, subclass, or flight that is extremely limited in numbers and not intended to supplant the origin category. Oftentimes used to explore potential variations for future upgrades. Ex: the Bonhomme Richard subclass (Type 2)

UEDP: United Earth Defense Pact. Formed by the NUN in 2069 to put the "Earth's ascendancy and safety ahead of national goals". Tasked with the combined command and control of the planet's various armed forces, it became the de facto world government upon the NUN's second dissolution in 2079, until superseded by the United Earth government in 2130.

UES: United Earth Ship. Ship prefix for the names of vessels of the UESN.

UESF: (see Starfleet)

UESN: United Earth Stellar Navy. Predecessor to the UESF. Formed under the authority of the United Earth Defense Pact in 2069.

UESPA: United Earth Space Probe Agency. Formed by the NUN in 2067, relieving the ISA of the coordination and development of human presence in interstellar space. Re-purposed as the exploration arm of the NUN in 2069.

UESS: United Earth Space Ship. Ship prefix for the names of vessels of the United Earth Starfleet.

UFP: United Federation of Planets. Formed in 2161 by a coalition of United Earth, the Andorian Empire, Tellar, Alpha Centauri, and the Confederacy of Vulcan, following the Romulan War.

UFP SF: (see Star Fleet)

USS: UFP Star Fleet Starship. Ship prefix for the names of Star Fleet vessels, emblazoned on ship hulls (along with the ship's registry number). Commonly abbreviated as "United Starship" in verbal communication, although the expressions "United Spaceship" and "Federation Starship" are also frequently used.

Work Pod: The general name for manned, sub-impulse craft used for construction, maintenance, repair, and other service tasks in space. A variety of external tools and modules are attached to the work pods to facilitate a multitude of tasks.



Delta Dynamics appreciates the sponsorship of the following:



Tigan Pergium Mining



Federation News Network (FNN)



Earth Sciences Institute



Plexicorp



The Anbo-iyutsu Society



Utopia Planitia Shipyards



Vulcan Science Academy



Starfleet Academy

...and Members like you.



THE FOLLOWING ARE OTHER STARSHIP RECOGNITION MANUALS
PUBLISHED BY DELTA DYNAMICS:

REPORTS

- BONAVENTURE survey cruiser
- BONAVENTURE dilithium power testbed
- BURKE frigates
- CONSTITUTION heavy cruisers
- DURANCE cargo tugs
- HORIZON heavy cruisers
- SYRACUSE destroyers
- TRENT destroyers

